

Features

- 30-inch minimum base cabinet width.
- Single bowl.
- 9" depth provides generous workspace.
- Single faucet hole.
- Bowl slopes 2 degrees toward drain to minimize water pooling.
- Offset drain increases workspace in the sink and storage space underneath.
- Includes K-9137 bottom sink rack.

Material

- KOHLER® enameled cast iron.

Installation

- Top-mount.

Recommended Products/Accessories

- K-8801 Sink Strainer
- K-8799 Sink Strainer
- K-23726 Drain treatment
- K-23725 Cast iron cleaner

Optional Products/Accessories

- K-11352 Disposal Flange with Stopper
- K-9000 P-Trap

Included Components

- Product consists of:
- K-9137 Sink Rack



Codes/Standards











ASME A112.19.1/CSA B45.2

KOHLER® Enameled Cast Iron Kitchen Sink Lifetime Limited Warranty

See website for detailed warranty information.

Available Colors/Finishes

Color tiles intended for reference only.

| Color | Code | Description |
|--|------|--------------|
|  | 0 | White |
|  | FF | Sea Salt™ |
|  | 96 | Biscuit |
|  | 47 | Almond |
|  | FD | Cane Sugar™ |
|  | 95 | Ice™ Grey |
|  | G9 | Sandbar |
|  | K4 | Cashmere |
|  | KA | Black 'n Tan |
|  | 7 | Black Black™ |

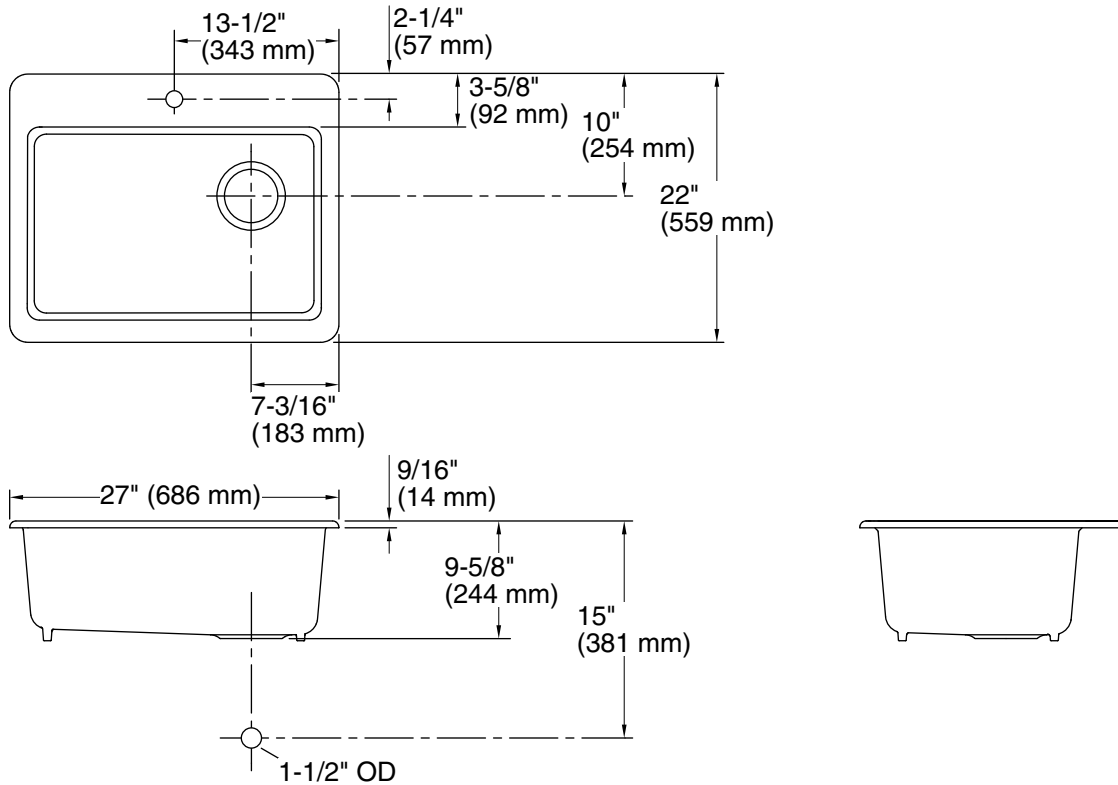

Technical Information

All product dimensions are nominal.

| | |
|--------------------------|--|
| Bowl configuration: | Single |
| Installation: | Top-mount |
| Min. base cabinet width: | 27" (686 mm) |
| Bowl area: | Length: 24-1/4" (616 mm) Width: 17-1/4" (438 mm) Bowl depth: 9" (229 mm) Water depth: 9" (229 mm) |
| Drain hole: | 3-7/8" (98 mm) |
| Template: | 1244382-7, required, included |

Notes

Install this product according to the installation instructions.