

### Features

- 1/2" NPT connections
- Available 27- or 54-nozzle configurations
- 2.0 gpm (7.6 lpm) maximum flow rate at 80 psi (5.5 bar)

### Recommended Products/Accessories

K-23723 Faucet cleaner



### Codes/Standards







ASME A112.18.1/CSA B125.1  
DOE - Energy Policy Act 1992  
IAPMO Certification

### KOHLER<sup>®</sup> Faucet Lifetime Limited Warranty

See website for detailed warranty information.

### Available Colors/Finishes

*Color tiles intended for reference only.*

Color	Code	Description
	CP	Polished Chrome
	SN	Vibrant <sup>®</sup> Polished Nickel
	AF	Vibrant <sup>®</sup> French Gold
	BN	Vibrant <sup>®</sup> Brushed Nickel
	BV	Vibrant <sup>®</sup> Brushed Bronze
	BL	Matte Black
	2MB	Vibrant <sup>®</sup> Brushed Moderne Brass
	TT	Vibrant Titanium

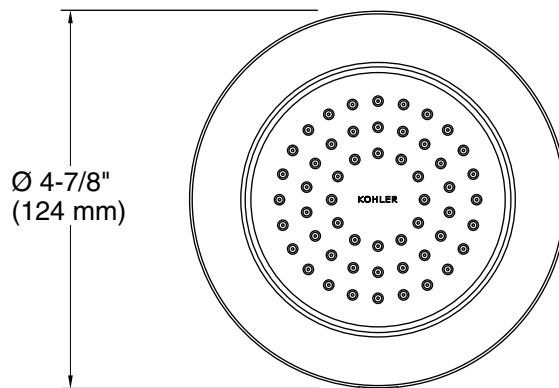
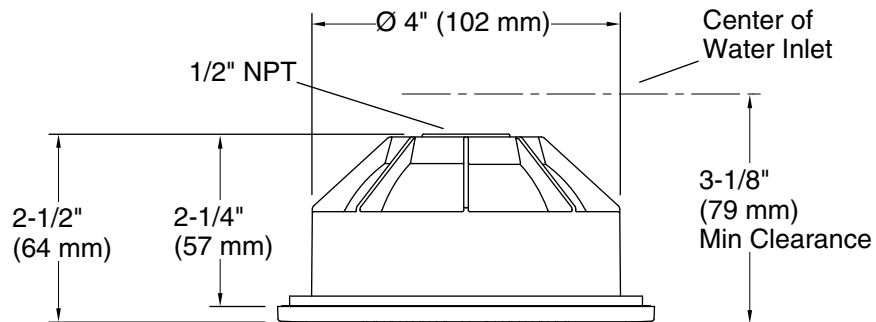

### Technical Information

All product dimensions are nominal.

### Notes

Install this product according to the installation instructions.