



# Iron/Tones®

21" top-/undermount single-bowl bar sink  
K-6587

## Features

- Single bowl
- 9-1/2" (241 mm) depth provides generous workspace
- Sink drain with strainer sold separately

## Material

- KOHLER® enameled cast iron
- Acid-resistant enamel finish

## Installation

- Top-mount or undermount
- Minimum base cabinet width: 21"-24" (21" may require cabinet modifications)

## Recommended Products/Accessories

- K-8801 Sink drain and strainer with tailpiece
- K-8799 Sink drain and strainer basket
- K-23726 Drain treatment
- K-23725 Cast iron cleaner

## Optional Products/Accessories

- K-11352 Disposal Flange with Stopper

## Included Components

- 52047 Clamp Accessory Pack, 4 Ea.



## Codes/Standards











- ASME A112.19.1/CSA B45.2
- IAPMO Certification

## KOHLER® Enameled Cast Iron Kitchen and Bathroom Sink Lifetime Limited Warranty

See website for detailed warranty information.

## Available Colors/Finishes

*Color tiles intended for reference only.*

Color	Code	Description
	0	White
	FF	Sea Salt™
	96	Biscuit
	NY	Dune
	95	Ice™ Grey
	58	Thunder™ Grey
	7	Black Black™
	TRF	Truffle
	17	Teal
	42	Aspen Green
	34	Fresh Green

1-800-4KOHLER (1-800-456-4537)

Kohler Co. reserves the right to make revisions without notice to product specifications.

For the most current Specification Sheet, go to [www.kohler.com](http://www.kohler.com) USA or [www.kohler.ca](http://www.kohler.ca) Canada

6-8-2024 20:53 - US

THE BOLD LOOK  
OF **KOHLER**®

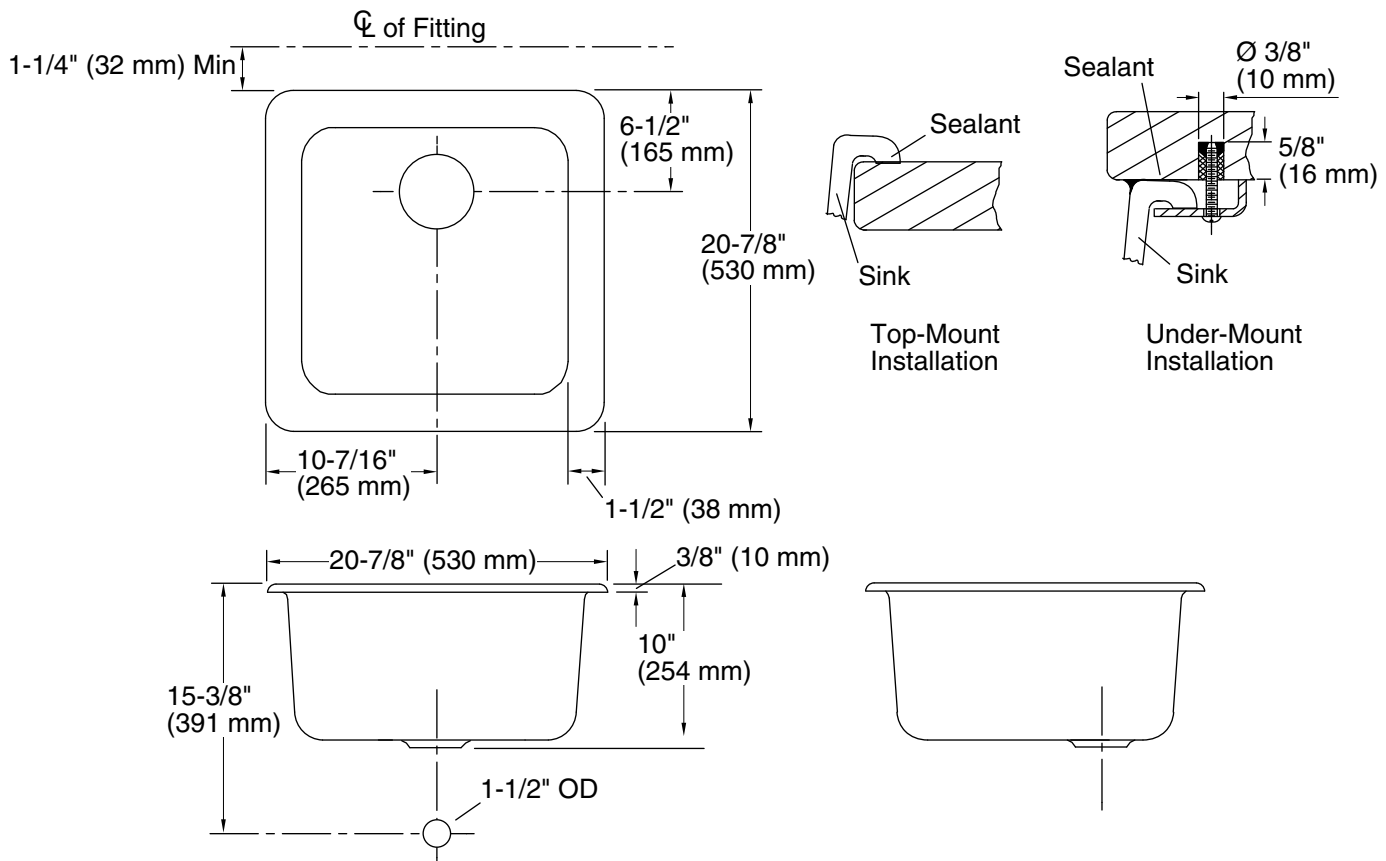

### Technical Information

All product dimensions are nominal.

Bowl configuration:	Single
Min. base cabinet width:	24" (610 mm)
Bowl area (Only):	Length: 18" (457 mm) Width: 18" (457 mm) Bowl depth: 9-1/2" (241 mm)
Drain hole:	3-7/8" (98 mm)
Template:	114335-7, required, included

### Notes

Install this product according to the installation instructions.

Supplied bowl clamp assemblies require 1" (25 mm) minimum countertop thickness. Installer must supply hardware for thinner countertops.

For multiple bowl under-mount installations, a minimum distance of 3-3/8" (86 mm) is required between bowls. Countertop supplier to determine required support.