



# Iron/Tones®

27" top-/undermount single-bowl kitchen sink  
**K-5708**

## Features

- 30" (762 mm) minimum base cabinet width
- Single bowl
- 9" (229 mm) depth provides generous workspace

## Material

- KOHLER® enameled cast iron

## Installation

- Top-mount or undermount

## Recommended Products/Accessories

- K-8801 Sink drain and strainer with tailpiece
- K-8799 Sink drain and strainer basket
- K-23726 Drain treatment
- K-23725 Cast iron cleaner
- 1411886 Undermount sink kit 23"

## Optional Products/Accessories

- K-8343 Sink rack for Iron/Tones® kitchen sink
- K-11352 Disposal Flange with Stopper
- K-9000 P-Trap



## Codes/Standards











- ASME A112.19.1/CSA B45.2
- IAPMO Certification

## KOHLER® Enameled Cast Iron Kitchen and Bathroom Sink Lifetime Limited Warranty

See website for detailed warranty information.

## Available Colors/Finishes

*Color tiles intended for reference only.*

Color	Code	Description
	0	White
	FF	Sea Salt™
	96	Biscuit
	NY	Dune
	95	Ice™ Grey
	58	Thunder™ Grey
	7	Black Black™
	TRF	Truffle
	17	Teal
	42	Aspen Green
	34	Fresh Green

1-800-4KOHLER (1-800-456-4537)

Kohler Co. reserves the right to make revisions without notice to product specifications.

For the most current Specification Sheet, go to [www.kohler.com](http://www.kohler.com) USA or [www.kohler.ca](http://www.kohler.ca) Canada

6-8-2024 20:27 - US

THE BOLD LOOK  
OF **KOHLER**®

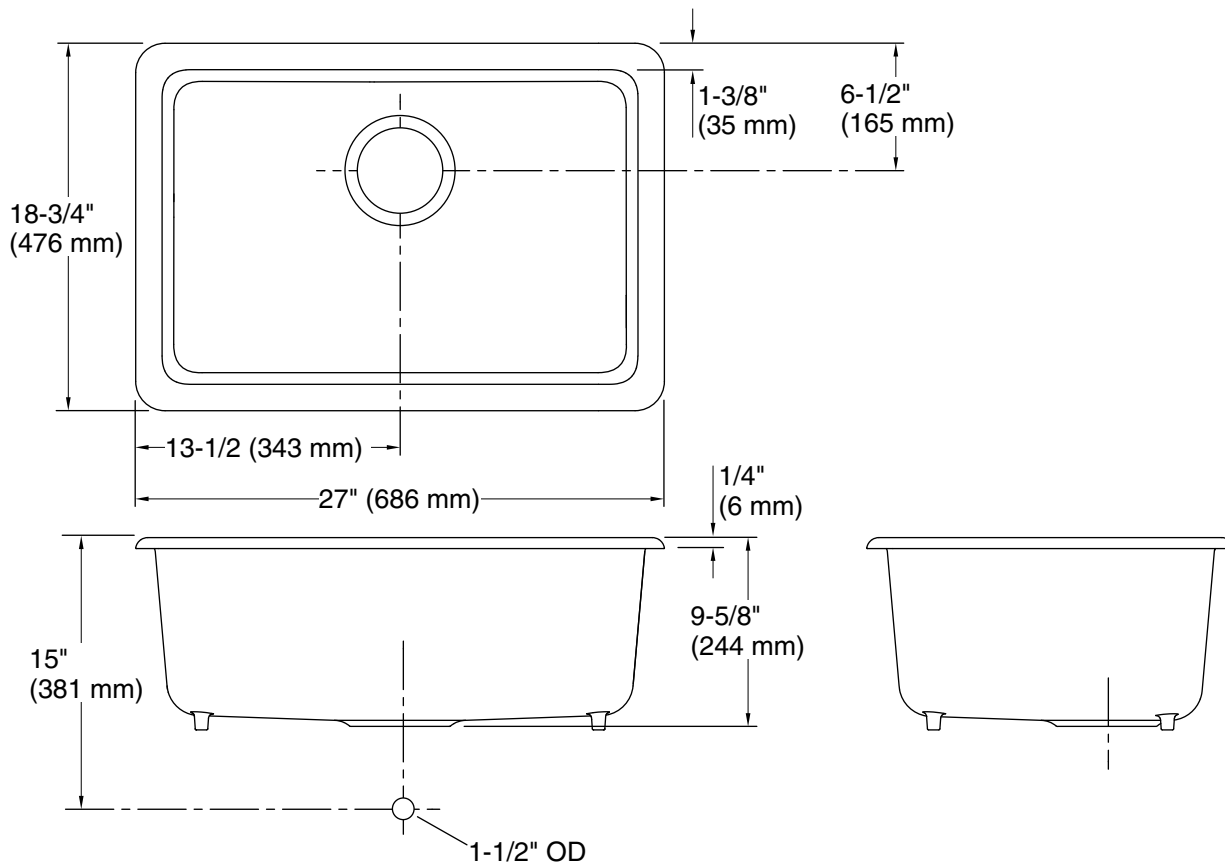

## Technical Information

All product dimensions are nominal.

Bowl configuration: Single

Min. base cabinet width: 30" (762 mm)

Bowl area (Only):  
 Length: 24-5/16" (617 mm)  
 Width: 16-1/16" (408 mm)  
 Bowl depth: 9" (229 mm)  
 Water depth: 9" (229 mm)

Drain hole: 3-7/8" (98 mm)

Template: 1281370-7, required, included

## Notes

Install this product according to the installation instructions.

Countertop manufacturer or cutter must use the cut-out template provided with the product, or a current one provided by Kohler Co. (call 1-800-43-FOCUS). Kohler Co. is not responsible for cut-out errors when the incorrect cut-out template is used.