

## Features

- 27" (686 mm) minimum base cabinet width
- Single bowl
- 9-1/2" (241 mm) depth provides generous workspace
- Includes K-80037 bottom sink rack
- Includes cutout templates and installation clips
- Matte finish offers rich, dimensional color

## Material

- KOHLER Neoroc® composite is durable and built to withstand day-to-day cleaning tasks
- Solid color throughout the sink
- Heat-resistant up to 750°F
- Scratch-, stain-, chip-, and thermal-shock-resistant

## Installation

- Undermount
- Easy to install in a one-person, single-day project

## Recommended Products/Accessories

- K-8801 Sink drain and strainer with tailpiece
- K-8799 Sink drain and strainer basket
- K-23726 Drain treatment
- K-23730 Neoroc® cleaner

## Optional Products/Accessories

- K-11352 Disposal Flange with Stopper
- K-9000 P-Trap

## Included Components

- K-80037 Sink Rack



## Codes/Standards







CSA B45.5/IAPMO Z124  
IAPMO Certification

## KOHLER® Neoroc® Sinks Lifetime Limited Warranty

See website for detailed warranty information.

## Available Colors/Finishes

*Color tiles intended for reference only.*

Color	Code	Description
	CM6	Matte White
	CM7	Matte Graphite
	CM1	Matte Black
	CM2	Matte Brown
	CM3	Matte Taupe
	CM4	Matte Grey

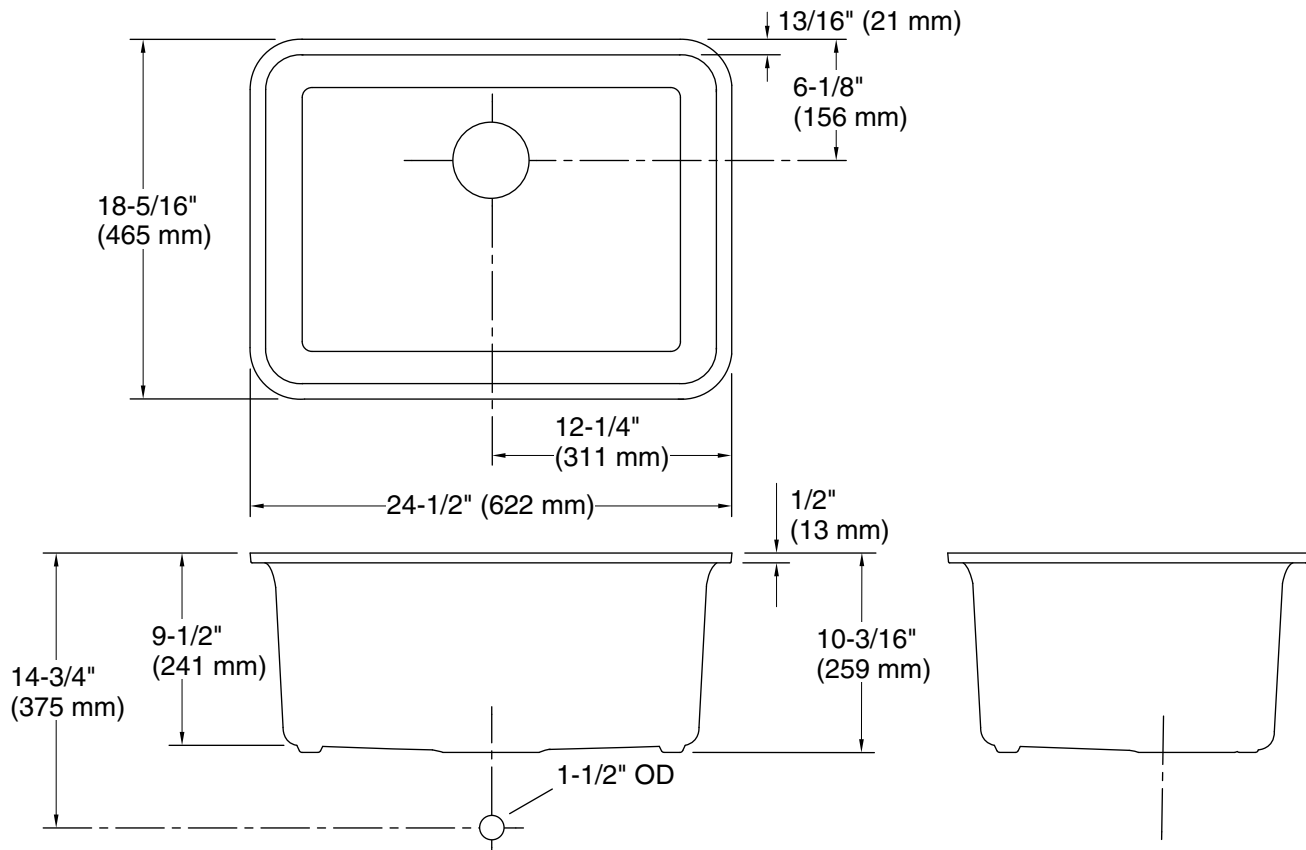

## Technical Information

All product dimensions are nominal.

Min. base cabinet width: 27" (686 mm)

Bowl area (Only):  
Length: 22-9/16" (573 mm)  
Width: 16-3/8" (416 mm)  
Bowl depth: 9-1/2" (241 mm)  
Water depth: 9-1/2" (241 mm)

Template: 1316451-7, required, included

## Notes

Install this product according to the installation instructions.

Countertop manufacturer or cutter must use the cut-out template provided with the product, or a current one provided by Kohler Co. (call 1-800-43-FOCUS). Kohler Co. is not responsible for cut-out errors when the incorrect cut-out template is used.