

Features

- Fits minimum 36" apron sink base cabinet.
- 9-1/2"-deep single bowl.
- Shortened apron allows sink to be used in most standard cabinetry or retrofitted to existing standard cabinetry.
- Plain front design.
- Matte finish offers rich, dimensional color.
- Solid color throughout the sink.
- Scratch, stain, chip, and thermal-shock resistant.
- Offset drain increases workspace in the sink and storage space underneath.

Material

- KOHLER Neoroc® composite is durable and built to withstand day-to-day cleaning tasks.
- Heat resistant up to 750°F.

Installation

- Undermount.
- No faucet holes.
- Self-Trimming® apron overlaps the cabinet face for easy installation.

Included Components

- K-26026 Farmhouse kitchen sink towel hook
- K-30182 Sink racks



Codes/Standards







CSA B45.5/IAPMO Z124
IAPMO Certification

KOHLER® Neoroc® Sinks Lifetime Limited Warranty

See website for detailed warranty information.

Available Colors/Finishes

Color tiles intended for reference only.

Color	Code	Description
	CM6	Matte White
	CM7	Matte Graphite
	CM1	Matte Black
	CM2	Matte Brown
	CM3	Matte Taupe
	CM4	Matte Grey

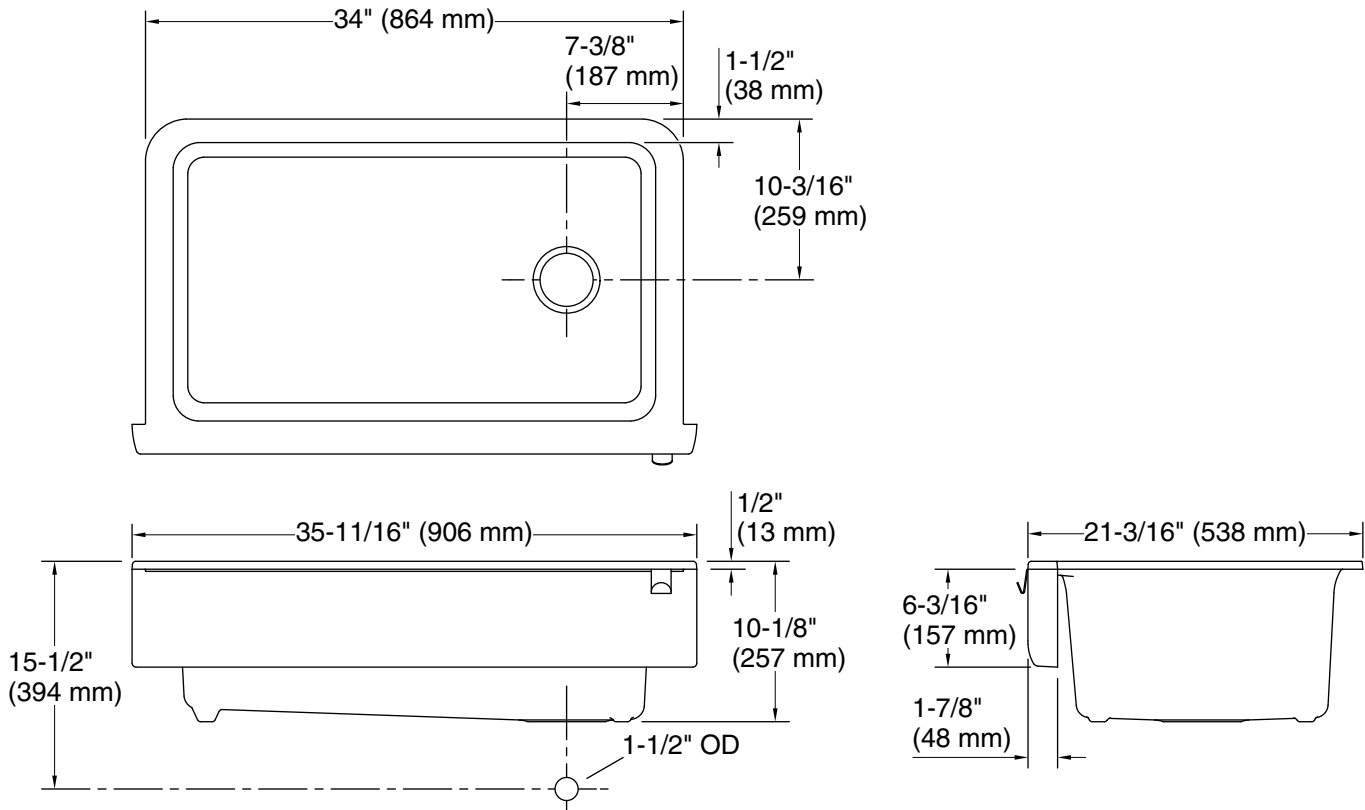

Technical Information

All product dimensions are nominal.

Bowl configuration: Single

Min. base cabinet width: 36" (914 mm)

Bowl area (Only):
Length: 28-5/8" (726 mm)
Width: 15-1/2" (394 mm)
Bowl depth: 9-1/2" (241 mm)
Water depth: 9-1/2" (241 mm)

Drain hole: 3-7/8" (98 mm)

Template: Apron-front, 1400299-7, required, included

Notes

Install this product according to the installation instructions.