

Features

- Bask® heated surface creates spa-like relaxation with soothing warmth on your back, shoulders, and neck
- Three heat settings allow you to customize the surface temperature
- Comfort Depth® design offers a convenient 19" step-over height while retaining the same depth as a standard 21" bath
- Integral lumbar support
- Slotted overflow allows for deep soaking
- Textured bottom surface
- Coordinates with other products in the Archer collection

Material

- Acrylic

Installation

- Reversible drain
- Requires K-7271 or K-7272 Clearflo slotted overflow bath drain (sold separately)
- Drop-in

Required Products/Accessories

K-7271 Brass Slotted Overflow Bath Drain

or

K-7272 PVC Slotted Overflow Bath Drain

Recommended Products/Accessories

K-1491 Bath/Whirlpool Pillow

K-1601 Bath/whirlpool footstop, removable

K-23726 Drain treatment

K-23732 Tub & shower cleaner

K-31797 Slotted overflow bath drain kit

K-31795 Slotted overflow above-the-floor bath drain kit



ADA

Codes/Standards

CSA B45.5/IAPMO Z124

UL 1795

CSA C22.2 No. 218.2

ADA

ICC/ANSI A117.1

IAPMO Certification

cUL Listed







UL Listed

KOHLER® Plastic Baths and Receptors Lifetime Limited Warranty
KOHLER® Hydrotherapy Components Five-Year Limited Warranty

See website for detailed warranty information.

Available Colors/Finishes

Color tiles intended for reference only.

Color	Code	Description
	0	White
	96	Biscuit
	NY	Dune
	95	Ice™ Grey
	58	Thunder™ Grey
	7	Black Black™

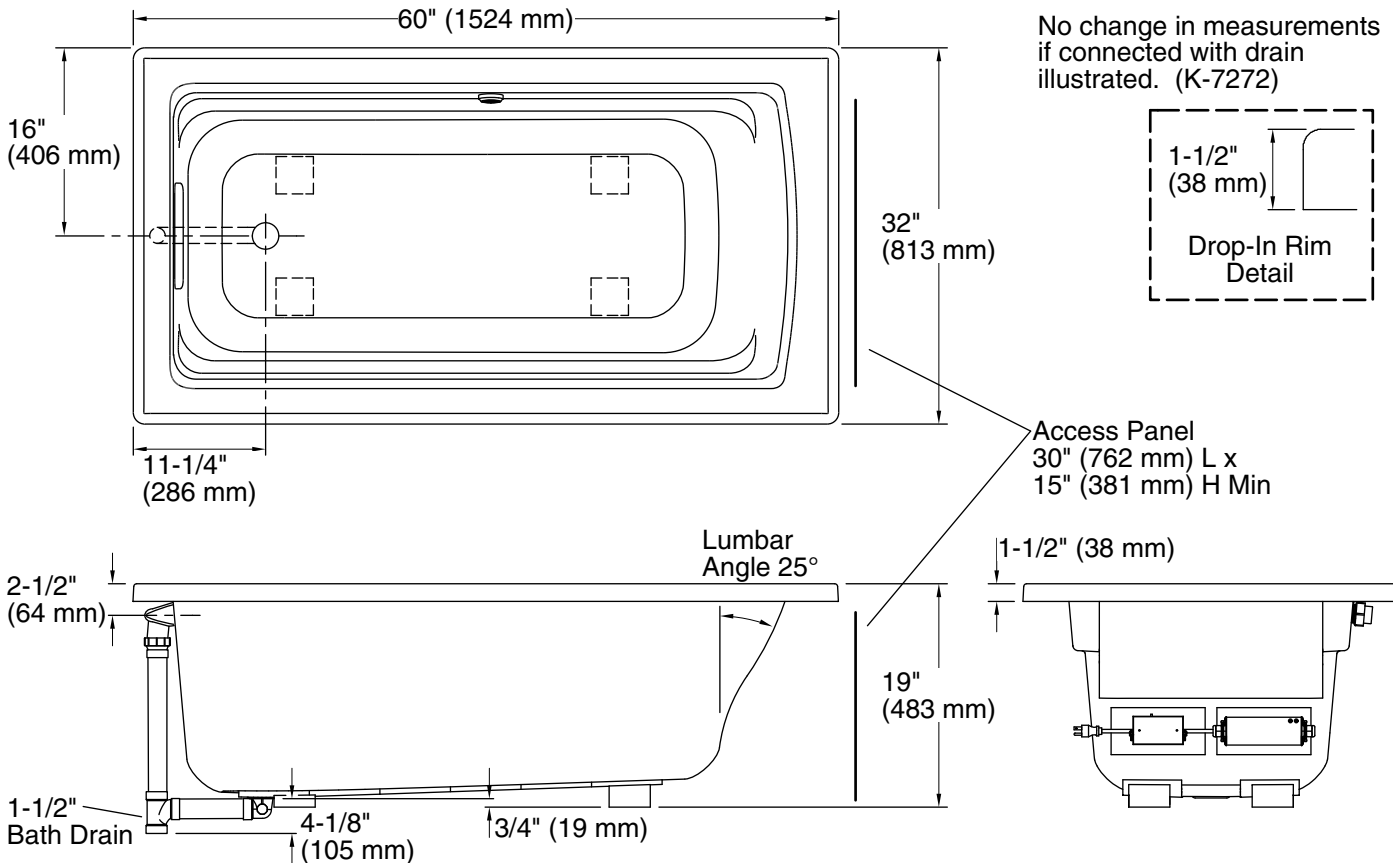

Required Electrical Service

One circuit required, protected with Class A Ground-Fault Circuit-Interrupter (GFCI). Outside North America, this device may be known as a Residual Current Device (RCD).

Heated Surface: 120 V, 15 A

Technical Information

All product dimensions are nominal.

Drain location: Reversible

Basin area, bottom: 45-1/8" x 19-11/16" (1146 mm x 500 mm)

Basin area, top: 52-3/4" x 25-5/16" (1340 mm x 643 mm)

Weight: 70 lbs (31.8 kg)

Minimum floor load: 44 lbs/ft² (214.8 kg/m²)

Water depth: 15" (381 mm)

Water capacity: 58 gal (219.6 L)

Cutout: Drop-in, 58-1/2" x 30-1/2" (1486 mm x 775 mm)

Electrical component rating: Heated Surface: 120 V, 0.5 A, 60 Hz, 65 W

Minimum flat for 2-1/8" (54 mm)

1-800-4KOHLER (1-800-456-4537)

Kohler Co. reserves the right to make revisions without notice to product specifications.

For the most current Specification Sheet, go to www.kohler.com USA or www.kohler.ca Canada

2-28-2024 21:08 - US

Notes

Measure your actual product for rough-in details.

Install this product according to the installation instructions.

The hot water supply should be 70% of the capacity of the bath or greater. Installations will vary.

This bath is designed for drop-in installation only. It is not suited for use in a three wall alcove with an overhead shower.

ADA compliant when installed to the specific requirements of these regulations.