

Features

- Comfort Depth® design offers a convenient 19" step-over height while retaining the same depth as a standard 21" bath
- Integral lumbar support
- Slotted overflow allows for deep soaking
- Integral apron
- Integral flange helps prevent water from seeping behind wall and simplifies alcove installation
- Textured bottom surface
- Coordinates with other products in the Archer collection

Material

- Acrylic

Installation

- Left drain
- Requires K-7271 or K-7272 Clearflo slotted overflow bath drain (sold separately)
- Alcove

Required Products/Accessories

K-7271 Brass Slotted Overflow Bath Drain

or

K-7272 PVC Slotted Overflow Bath Drain

Recommended Products/Accessories

K-23726 Drain treatment

K-23732 Tub & shower cleaner

K-31797 Slotted overflow bath drain kit

K-31795 Slotted overflow above-the-floor bath drain kit



ADA

Codes/Standards

CSA B45.5/IAPMO Z124

ADA

ICC/ANSI A117.1





IAPMO Certification

KOHLER® Plastic Baths and Receptors Lifetime Limited Warranty

See website for detailed warranty information.

Available Colors/Finishes

Color tiles intended for reference only.

Color	Code	Description
	0	White
	95	Ice™ Grey
	58	Thunder™ Grey
	7	Black Black™

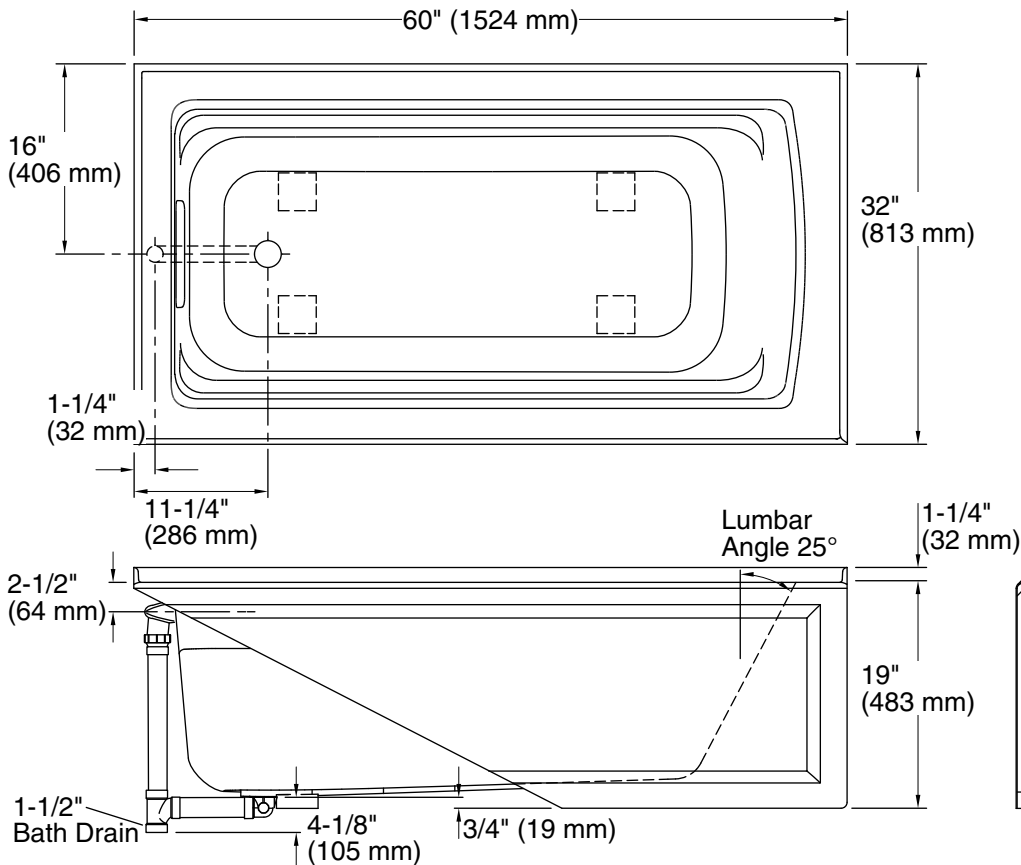

No change in measurements if connected with drain illustrated. (K-7272)

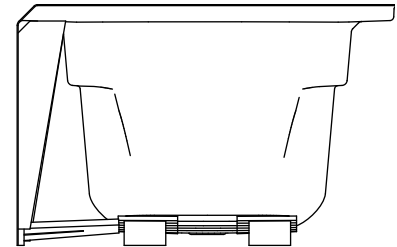
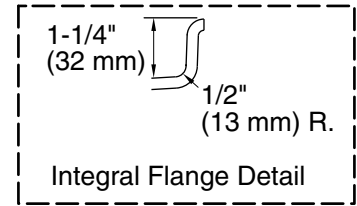

Technical Information

All product dimensions are nominal.

Drain location:	Left
Basin area, bottom:	45-1/8" x 19-11/16" (1146 mm x 495 mm)
Basin area, top:	52-3/4" x 25-5/16" (1340 mm x 643 mm)
Weight:	80 lbs (36.3 kg)
Minimum floor load:	45 lbs/ft ² (219.7 kg/m ²)
Water depth:	15" (381 mm)
Water capacity:	58 gal (219.6 L)
Minimum flat for door:	2-9/16" (65 mm)

Notes

Measure your actual product for rough-in details.

Install this product according to the installation instructions.

The hot water supply should be 70% of the capacity of the bath or greater. Installations will vary.

ADA compliant when installed to the specific requirements of these regulations.