

KDxxxx-YF designates a 50 Hz generator set with a fuel optimized engine.

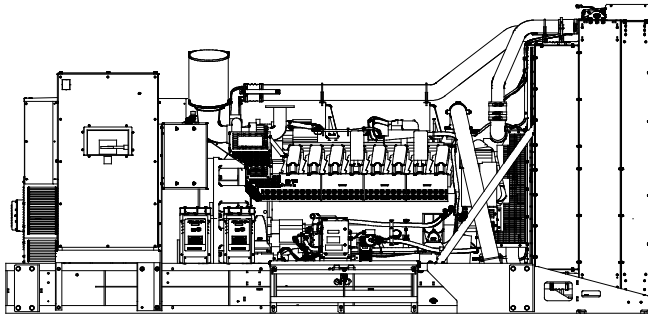

Ratings Range

		50 Hz	
Standby:	kW	1080-1200	
	kVA	1350-1500	
Prime:	kW	968-1080	
	kVA	1210-1350	

Standard Features

- Kohler Co. provides one-source responsibility for the generating system and accessories.
- The generator set and its components are prototype-tested, factory-built, and production-tested.
- The generator set accepts rated load in one step.
- A standard three-year or 1000-hour limited warranty for standby applications. Five-year basic, five-year comprehensive, and ten-year extended limited warranties are also available.
- A standard two-year or 8700-hour limited warranty for prime power applications.
- Other features:
 - Kohler designed controllers for one-source system integration and remote communication. See Controllers on page 4.
 - The low coolant level shutdown prevents overheating (standard on radiator models only).

General Specifications

Orderable Generator Model Number	GMKD1350
Manufacturer	Kohler
Alternator Choices	KH03850TO4D KH04920TO4D KH05520TO4D KH05740TO4D KH05641TO4D KH06721TO4D KH06810TO4D
Performance Class	Per ISO 8528-5
One Step Load Acceptance	100%
Voltage	Wye or 3300 V
Controller	APM603, APM802
Fuel Tank Capacity, L (gal.)	5863-21985 (1549-5808)
Fuel Consumption, L/hr (gal./hr) 100% at Standby	316 (83.5)
Fuel Consumption, L/hr (gal./hr) 100% at Prime Power	287 (75.8)
Data Center Continuous (DCC) Rating (Refer to TIB-101 for definitions)	Same as the Standby Rating below

Generator Set Ratings

Alternator	Voltage	Ph	Hz	150°C Rise Standby Rating		130°C Rise Standby Rating		125°C Rise Prime Rating		105°C Rise Prime Rating	
				kW/kVA	Amps	kW/kVA	Amps	kW/kVA	Amps	kW/kVA	Amps
KH03850TO4D	220/380	3	50	1200/1500	2279	1200/1500	2279	1080/1350	2051	1080/1350	2051
	230/400	3	50	1200/1500	2165	1200/1500	2165	1080/1350	1949	1080/1350	1949
	240/415	3	50	1200/1500	2087	1200/1500	2087	1080/1350	1878	1080/1350	1878
KH04920TO4D	220/380	3	50	1200/1500	2279	1200/1500	2279	1080/1350	2051	1080/1350	2051
	230/400	3	50	1200/1500	2165	1200/1500	2165	1080/1350	1949	1080/1350	1949
	240/415	3	50	1200/1500	2087	1200/1500	2087	1080/1350	1878	1080/1350	1878
KH05520TO4D	220/380	3	50	1176/1470	2233	1136/1420	2158	1080/1350	2051	1024/1280	1945
	230/400	3	50	1176/1470	2122	1136/1420	2050	1080/1350	1949	1024/1280	1848
	240/415	3	50	1120/1400	1948	1080/1350	1878	1064/1330	1850	968/1210	1683
KH05740TO4D	220/380	3	50	1200/1500	2279	1200/1500	2279	1080/1350	2051	1080/1350	2051
	230/400	3	50	1200/1500	2165	1200/1500	2165	1080/1350	1949	1080/1350	1949
	240/415	3	50	1200/1500	2087	1200/1500	2087	1080/1350	1878	1080/1350	1878
KH06810TO4D	220/380	3	50	1200/1500	2279	1200/1500	2279	1080/1350	2051	1080/1350	2051
	230/400	3	50	1200/1500	2165	1200/1500	2165	1080/1350	1949	1080/1350	1949
	240/415	3	50	1200/1500	2087	1200/1500	2087	1080/1350	1878	1080/1350	1878
KH05641TO4D	1905/3300	3	50	1200/1500	262	1200/1500	262	1080/1350	236	1080/1350	236
KH06721TO4D	1905/3300	3	50	1200/1500	262	1200/1500	262	1080/1350	236	1080/1350	236

RATINGS: All three-phase units are rated at 0.8 power factor. **Standby Ratings:** The standby rating is applicable to varying loads for the duration of a power outage. There is no overload capability for this rating. **Prime Power Ratings:** At varying load, the number of generator set operating hours is unlimited. A 10% overload capacity is available for one hour in twelve. Ratings are in accordance with ISO-8528-1 and ISO-3046-1. For limited running time and continuous ratings, consult the factory. Obtain technical information bulletin (TIB-101) for ratings guidelines, complete ratings definitions, and site condition derates. The generator set manufacturer reserves the right to change the design or specifications without notice and without any obligation or liability whatsoever.

Engine Specifications	50 Hz
Manufacturer	Kohler
Engine: model	KD36V16
Engine: type	4-Cycle, Turbocharged, Intercooled
Cylinder arrangement	16-V
Displacement, L (cu. in.)	36 (2197)
Bore and stroke, mm (in.)	135 x 157 (5.31 x 6.18)
Compression ratio	15.0:1
Piston speed, m/min. (ft./min.)	471 (1545)
Main bearings: quantity, type	11, Precision Half Shells
Rated rpm	1500
Max. power at rated rpm, kWm (BHP)	1333 (1788)
Cylinder head material	Cast Iron
Crankshaft material	Steel
Valve (exhaust) material	Steel
Governor: type, make/model	KODEC Electronic Control
Frequency regulation, no-load to-full load	Isochronous
Frequency regulation, steady state	±0.25%
Frequency	Fixed
Air cleaner type, all models	Dry
Lubricating System	50 Hz
Type	Full Pressure
Oil pan capacity with filter (dipstick max mark), L (qt.)	135 (143)
Oil pan capacity with filter (initial fill), L (qt.)	152 (161)
Oil filter: quantity, type	4, Cartridge
Oil cooler	Water-Cooled
Fuel System	50 Hz
Fuel supply line, min. ID, mm (in.)	19 (0.75)
Fuel return line, min. ID, mm (in.)	12 (0.5)
Max. fuel flow, Lph (gph)	480 (127)
Min./max. fuel pressure at engine supply connection, kPa (in. Hg)	-30/30 (-8.8/8.8)
Maximum diesel fuel lift, m (ft.)	3.7 (12)
Max. return line restriction, kPa (in. Hg)	30 (8.8)
Fuel filter: quantity, type	1, Primary Engine Filter 1, Fuel/Water Separator
Recommended fuel	#2 Diesel ULSD

Fuel Consumption	50 Hz
Diesel, Lph (gph) at % load	Standby Rating
100%	316 (83.5)
75%	234 (61.8)
50%	159 (42.0)
25%	84 (22.2)
Diesel, Lph (gph) at % load	Prime Rating
100%	287 (75.8)
75%	213 (56.3)
50%	145 (38.3)
25%	78 (20.6)
Radiator System	50 Hz
Ambient temperature, °C (°F)*	40 (104)
Engine jacket water capacity, L (gal.)	124 (33)
Radiator system capacity, including engine, L (gal.)	235 (62)
Engine jacket water flow, Lpm (gpm)	1723 (455)
Heat rejected to cooling water at rated kW, dry exhaust, kW (Btu/min.)	511 (29085)
Heat rejected to charge air cooler at rated kW, dry exhaust, kW (Btu/min.)	278 (15823)
Charge cooling air inlet temperature at 25°C (77°F) ambient, °C (°F)	223 (433)
Turbocharger boost (abs), bar (psi)	3.37 (48.9)
Water pump type	Centrifugal
Fan diameter, including blades, mm (in.)	1350 (53.1)
Fan, kWm (HP)	40 (53.6)
Max. restriction of cooling air, intake and discharge side of radiator, kPa (in. H ₂ O)	0.125 (0.5)

* Enclosure with enclosed silencer reduces ambient temperature capability by 5°C (9°F).

Remote Radiator System†	50 Hz
Exhaust manifold type	Dry
Connection sizes:	
Water inlet/outlet, mm (in.)	—
Charge air cooler inlet/outlet (pipe dia. of flange), mm (in.)	—
Static head allowable above engine, kPa (ft. H ₂ O)	70 (23.5)

† Contact your local distributor for cooling system options and specifications based on your specific requirements.

Exhaust System	50 Hz
Exhaust flow at rated kW, m ³ /min. (cfm)	211 (7463)
Exhaust temperature at rated kW at 25°C (77°F) ambient, dry exhaust, °C (°F)	541 (1006)
Maximum allowable back pressure, kPa (in. Hg)	8.5 (2.5)
Exh. outlet size at eng. hookup, mm (in.)	See ADV drawing

Electrical System	50 Hz
Battery charging alternator:	
Ground (negative/positive)	Negative
Volts (DC)	24
Ampere rating	140
Starter motor qty. at starter motor power rating, rated voltage (DC)	Standard: 2 @ 8.4 kW, 24; Redundant (optional): 4 @ 8.4 kW, 24
Battery, recommended cold cranking amps (CCA):	
Quantity, CCA rating each, type (with standard starters)	4, 1110, AGM
Quantity, CCA rating each, type (with optional redundant starters)	8, 1110, AGM
Battery voltage (DC)	12

Air Requirements	50 Hz
Radiator-cooled cooling air, m ³ /min. (scfm)‡	1224 (42225)
Cooling air required for generator set when equipped with city water cooling or remote radiator, based on 14°C (25°F) rise, m ³ /min. (scfm)‡	749 (26480)
Combustion air, m ³ /min. (cfm)	74 (2604)
Heat rejected to ambient air:	
Engine, kW (Btu/min.)	156 (8879)
Alternator, kW (Btu/min.)	66 (3789)

‡ Air density = 1.20 kg/m³ (0.075 lbm/ft³)

Alternator Specifications	50 Hz	
Type	4-Pole, Rotating-Field	
Exciter type	Brushless, Permanent-Magnet Pilot Exciter	
Voltage regulator	Solid-State, Volts/Hz	
Insulation:	NEMA MG1, UL 1446, Vacuum Pressure Impregnated (VPI)	
Material	Class H, Synthetic, Nonhygroscopic	
Temperature rise	130°C, 150°C Standby	
Bearing: quantity, type	1, Sealed	
Coupling	Flexible Disc	
Amortisseur windings	Full	
Alternator winding type (up to 600 V)	Random Wound	
Alternator winding type (above 600 V)	Form Wound	
Rotor balancing	125%	
Voltage regulation, no-load to full-load	±0.25%	
Unbalanced load capability	100% of Rated Standby Current	
Peak motor starting kVA:	(35% dip for voltages below)	
400 V	KH03850TO4D	4459
400 V	KH04920TO4D	5425
400 V	KH05520TO4D	3844
400 V	KH05740TO4D	5624
400 V	KH06810TO4D	7055

Alternator Standard Features

- The pilot-excited, permanent magnet (PM) alternator provides superior short-circuit capability.
- All models are brushless, rotating-field alternators.
- NEMA MG1, IEEE, and ANSI standards compliance for temperature rise and motor starting.
- Sustained short-circuit current of up to 300% of the rated current for up to 10 seconds.
- Sustained short-circuit current enabling downstream circuit breakers to trip without collapsing the alternator field.
- Self-ventilated and dripproof construction.
- Superior voltage waveform from two-thirds pitch windings and skewed stator.
- Brushless alternator with brushless pilot exciter for excellent load response.

NOTE: See TIB- 102 Alternator Data Sheets for alternator application data and ratings, efficiency curves, voltage dip with motor starting curves, and short circuit decrement curves.

Controllers

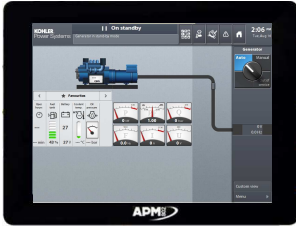

APM802 Controller

Provides advanced control, system monitoring, and system diagnostics for optimum performance and compatibility.

- 12-inch graphic display with touch screen and menu control provide easy local data access
- Measurements are selectable in metric or English units
- User language is selectable
- Two USB ports allow connection of a flash drive, mouse, or keypad
- Electrical data, mechanical data, and system settings can be saved to a flash drive
- Ethernet port allows connection to a PC type computer or Ethernet switch
- The controller supports Modbus® RTU and TCP protocols
- NFPA 110 Level 1 capability

Refer to G6-152 for additional controller features and accessories.

Modbus® is a registered trademark of Schneider Electric.



APM603 Controller

Provides advanced control, system monitoring, and system diagnostics for optimum performance and compatibility.

- 7-inch graphic display with touch screen and menu control provides easy local data access
- Measurements are selectable in metric or English units
- Paralleling capability to control up to 8 generators on an isolated bus with first-on logic, synchronizer, kW and kVAR load sharing, and protective relays
- Note: Parallel with other APM603 controllers only
- Generator management to turn paralleled generators off and on as required by load demand
- Load management to connect and disconnect loads as required
- Controller supports Modbus® RTU, Modbus® TCP, SNMP and BACnet®
- Integrated voltage regulator with ±0.25% regulation
- Built-in alternator thermal overload protection
- UL-listed overcurrent protective device
- NFPA 110 Level 1 capability

Refer to G6-162 for additional controller features and accessories.

BACnet® is a registered trademark of ASHRAE.

Codes and Standards

- Engine-generator set is designed and manufactured in facilities certified to standards ISO2008:9001 and ISO2004:14001.
- Generator set meets NEMA MG1, BS5000, ISO, DIN EN, and IEC standards, NFPA 110
- Engine generator set is tested to ISO 8528-5 for transient response.
- The generator set and its components are prototype-tested, factory-built, and production-tested.

Third-Party Compliance

Available Approvals and Listings

- cULus

Warranty Information

- A standard three-year or 1000-hour limited warranty for standby applications. Five-year basic, five-year comprehensive, and ten-year extended limited warranties are also available.
- A standard two-year or 8700-hour limited warranty for prime power applications.

Available Warranties for Standby Applications

- 5-Year Basic Limited
- 5-Year Comprehensive Limited
- 10-Year Major Components Limited

Standard Features

- Closed Crankcase Ventilation (CCV) Filters
- Customer Connection
- Generator Heater (3300 Volt)
- Integral Vibration Isolation
- Local Emergency Stop Switch
- Oil Drain and Coolant Drain Extension
- Operation and Installation Literature

Available Options

Circuit Breakers

- | Type | Rating |
|---|--|
| <input type="checkbox"/> Magnetic Trip | <input type="checkbox"/> 80% |
| <input type="checkbox"/> Thermal Magnetic Trip | <input type="checkbox"/> 100% |
| <input type="checkbox"/> Electronic Trip (LI) | Operation |
| <input type="checkbox"/> Electronic Trip with Short Time (LSI) | <input type="checkbox"/> Manual |
| <input type="checkbox"/> Electronic Trip with Ground Fault (LSIG) | <input type="checkbox"/> Electrically Operated (for paralleling) |

Circuit Breaker Mounting

- Generator Mounted
- Remote Mounted
- Bus Bar (for remote mounted breakers)

Enclosed Remote Mounted Circuit Breakers

- NEMA 1 (15- 5000 A)
- NEMA 3R (15- 1200 A)

Approvals and Listings

- cULus

Enclosed Unit

- Sound Level 1 Enclosure/Fuel Tank Package
- Sound Level 2 Enclosure/Fuel Tank Package

Open Unit

- Exhaust Silencer, Critical (kits: PA-361625 qty. 2)
- Exhaust Silencer, Hospital (kits: PA-361626 qty. 2)
- Flexible Exhaust Connector, Stainless Steel

Controller

- Input/Output, Digital
- Input/Output, Thermocouple (standard on 3300 V)
- Load Shed (APM802 only)
- Manual Key Switch
- Remote Emergency Stop Switch
- Lockable Emergency Stop Switch
- Remote Serial Annunciator Panel

Cooling System

- Block Heater; 9000 W, 380 V, 3 Ph
Required for ambient temperatures below 10°C (50°F).
Block heater kit includes air intake manifold grid heater.
- Radiator Guard and Duct Flange

Electrical System

- Battery, AGM (kit with qty. 4)
- Battery, AGM (kit with qty. 8)
- Battery Charger
- Battery Rack and Cables
- Generator Heater (up to 415 Volt)
- Redundant Starters

Fuel System

- Flexible Fuel Lines
- Restriction Gauge (for fuel/water separator)

Literature

- General Maintenance
- NFPA 110
- Overhaul
- Production

Miscellaneous

- Air Cleaner, Heavy Duty
- Air Cleaner Restriction Indicator
- Alternator Air Filter (will reduce generator set output up to 7%)
- Automatic Oil Replenishment System
- Engine Fluids (oil and coolant) Added
- Rated Power Factor Testing

Electrical Package

- Basic Electrical Package (select 1 Ph or 3 Ph)
- Wire Alternator Heater (1 Ph)
- Wire Battery Charger (1 Ph)
- Wire Block Heater (select 1 Ph or 3 Ph)
- Wire Controller Heater (1 Ph)

Warranty (Standby Applications only)

- 5-Year Basic Limited
- 5-Year Comprehensive Limited
- 10-Year Major Components Limited

Other

-
-

Dimensions and Weights

Overall Size, max., L x W x H, mm (in.): 5291 x 2184 x 2311
(208.3 x 86.0 x 91.0)

Weight, radiator model, max. wet, kg (lb.): 12896 (28443)

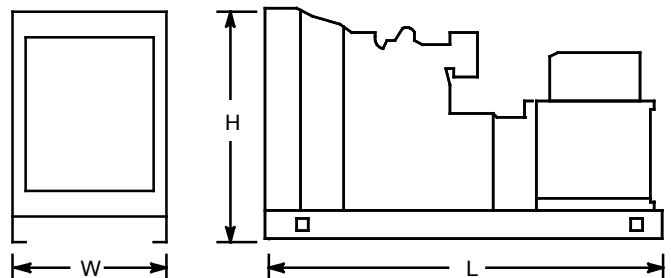

NOTE: This drawing is provided for reference only and should not be used for planning installation. Contact your local distributor for more detailed information.

KOHLER CO., Kohler, Wisconsin 53044 USA
Phone 920-457-4441, Fax 920-459-1646
For the nearest sales and service outlet in the
US and Canada, phone 1-800-544-2444
KOHLERPower.com

Sound Enclosures and Subbase Fuel Tank

Sound Level 1 Enclosure Standard Features

- Lift base or tank-mounted, aluminum construction enclosure with internal-mounted, exhaust silencers.
- Every enclosure has a sloped roof to reduce the buildup of moisture and debris.
- Sound attenuated enclosure that offers noise reduction using acoustic insulation, acoustic-lined air inlets and an acoustic-lined air discharge.
- Fade-, scratch-, and corrosion-resistant Kohler® Power Armor™ automotive-grade textured finish.
- Acoustic insulation that meets UL 94 HF1 flammability classification.
- Enclosure has large access doors that are hinged and removable which allow for easy maintenance.
- Lockable, flush-mounted door latches.
- Air inlet louvers reduce rain and snow entry.
- High wind bracing, 241 kph (150 mph).

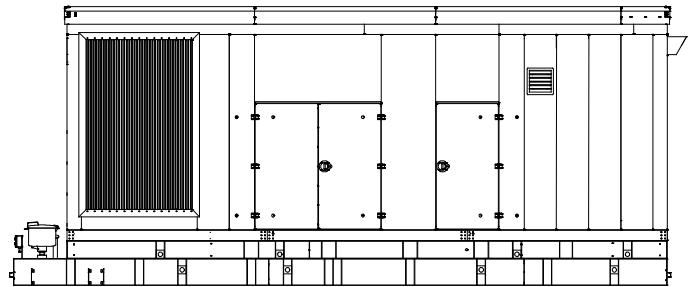

Sound Level 1 Enclosure
(Shown with available spill containment)

Sound Level 2 Enclosure Standard Features

- Includes all of the sound level 1 enclosure features with the addition of up to 51 mm (2 in.) acoustic insulation material, intake sound baffles, vertical air discharge, and secondary silencers.
- Louvered air inlet and vertical outlet hood with 90 degree angles to redirect air and reduce noise.

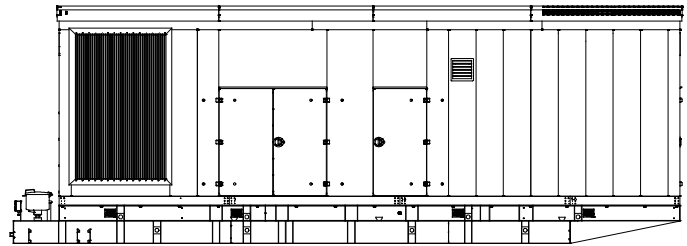

Sound Level 2 Enclosure
(Shown with available spill containment)

Subbase Fuel Tank Features

- The fuel tank has a Power Armor Plus™ textured epoxy-based rubberized coating.
- The above-ground rectangular secondary containment tank mounts directly to the generator set, below the generator set skid (subbase).
- Both the inner and outer tanks have UL-listed emergency relief vents.
- Flexible fuel lines are provided with subbase fuel tank selection.
- The containment tank's construction protects against fuel leaks or ruptures. The inner (primary) tank is sealed inside the outer (secondary) tank. The outer tank contains the fuel if the inner tank leaks or ruptures.
- The above ground secondary containment subbase fuel tank meets UL 142 requirements.
- Features include:
 - Additional fittings for optional accessories (qty. 3)
 - Electrical stub-up area open to bottom
 - Emergency inner and outer tank relief vents
 - Fuel fill with lockable cap and 51 mm (2 in.) riser
 - Fuel leak detection switch
 - Fuel level mechanical gauge
 - Fuel level sender
 - Normal vent
 - Removable engine supply and return diptubes

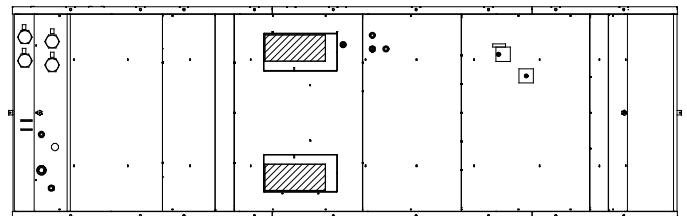

Subbase Fuel Tank (Top View)

DISTRIBUTED BY:

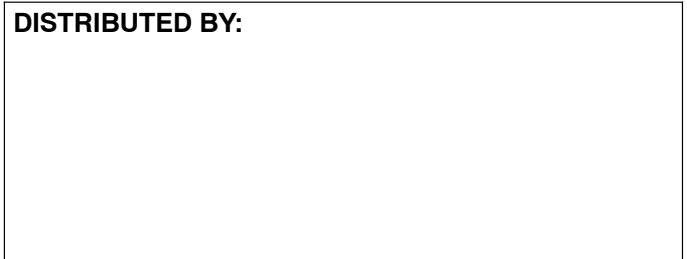

© 2017 Kohler Co. All rights reserved.