

OWNER'S MANUAL

KOHLER COMMAND CH18-CH26, CH620-CH750 HORIZONTAL CRANKSHAFT



KOHLER
ENGINES

Safety Precautions

To ensure safe operations please read the following statements and understand their meaning. Also refer to your equipment owner's manual for other important safety information. This manual contains safety precautions which are explained below. Please read carefully.

WARNING

Warning is used to indicate the presence of a hazard that *can* cause *severe* personal injury, death, or substantial property damage if the warning is ignored.

CAUTION



Caution is used to indicate the presence of a hazard that *will* or *can* cause *minor* personal injury or property damage if the caution is ignored.

NOTE



Note is used to notify people of installation, operation, or maintenance information that is important but not hazard-related.

For Your Safety!



These precautions should be followed at all times. Failure to follow these precautions could result in injury to yourself and others.

 WARNING

<p>Explosive Fuel can cause fires and severe burns.</p> <p>Do not fill the fuel tank while the engine is hot or running.</p>



Explosive Fuel!
Gasoline is extremely flammable and its vapors can explode if ignited. Store gasoline only in approved containers, in well ventilated, unoccupied buildings, away from sparks or flames. Do not fill the fuel tank while the engine is hot or running, since spilled fuel could ignite if it comes in contact with hot parts or sparks from ignition. Do not start the engine near spilled fuel. Never use gasoline as a cleaning agent.

 WARNING

<p>Rotating Parts can cause severe injury.</p> <p>Stay away while engine is in operation.</p>

Rotating Parts!
Keep hands, feet, hair, and clothing away from all moving parts to prevent injury. Never operate the engine with covers, shrouds, or guards removed.

 WARNING

<p>Hot Parts can cause severe burns.</p> <p>Do not touch engine while operating or just after stopping.</p>

Hot Parts!
Engine components can get extremely hot from operation. To prevent severe burns, do not touch these areas while the engine is running, or immediately after it is turned off. Never operate the engine with heat shields or guards removed.

 CAUTION

<p>Electrical Shock can cause injury.</p> <p>Do not touch wires while engine is running.</p>

Electrical Shock!
Never touch electrical wires or components while the engine is running. They can be sources of electrical shock.

California Proposition 65 Warning
<p><i>Engine exhaust from this product contains chemicals known to the State of California to cause cancer, birth defects, or other reproductive harm.</i></p>



Safety Precautions (Cont.)

 WARNING

Accidental Starts can cause severe injury or death. Disconnect and ground spark plug leads before servicing.



Accidental Starts!

Disabling engine. Accidental starting can cause severe injury or death. Before working on the engine or equipment, disable the engine as follows: 1) Disconnect the spark plug lead(s). 2) Disconnect negative (-) battery cable from battery.

 WARNING

Carbon Monoxide can cause severe nausea, fainting or death. Avoid inhaling exhaust fumes, and never run the engine in a closed building or confined area.

Lethal Exhaust Gases!

Engine exhaust gases contain poisonous carbon monoxide. Carbon monoxide is odorless, colorless, and can cause death if inhaled. Avoid inhaling exhaust fumes, and never run the engine in a closed building or confined area.

 WARNING

Explosive Gas can cause fires and severe acid burns. Charge battery only in a well ventilated area. Keep sources of ignition away.

Explosive Gas!

Batteries produce explosive hydrogen gas while being charged. To prevent a fire or explosion, charge batteries only in well ventilated areas. Keep sparks, open flames, and other sources of ignition away from the battery at all times. Keep batteries out of the reach of children. Remove all jewelry when servicing batteries.

Before disconnecting the negative (-) ground cable, make sure all switches are OFF. If ON, a spark will occur at the ground cable terminal which could cause an explosion if hydrogen gas or gasoline vapors are present.

Congratulations – You have selected a fine four-cycle, twin cylinder, air-cooled engine. Kohler designs long life strength and on-the-job durability into each engine...making a Kohler engine dependable...dependability you can count on. Here are some reasons why:

- Efficient overhead valve design and full pressure lubrication provide maximum power, torque, and reliability under all operating conditions.
- Dependable, maintenance-free electronic ignition ensures fast, easy starts time after time.
- Kohler engines are easy to service. All routine service areas like the dipstick, oil fill, air cleaner, and spark plugs are easily and quickly accessible.
- Parts subject to the most wear and tear (like the cylinder liner* and camshaft) are made from precision formulated cast iron. Because the cylinder liner* can be rebored, these engines can last even longer.

*Some CH25/26 engines have POWER-BORE™ Cylinders. These cylinders are plated with nickel-silicon to give increased power, virtually permanent cylinder life, superior oil control, and reduced exhaust emissions. These cylinders cannot be rebored.

- Every Kohler engine is backed by a worldwide network of over 10,000 distributors and dealers. Service support is just a phone call away. Call 1-800-544-2444 (U.S. & Canada) for Sales & Service assistance.

To keep your engine in top operating condition, follow the maintenance procedures in this manual.

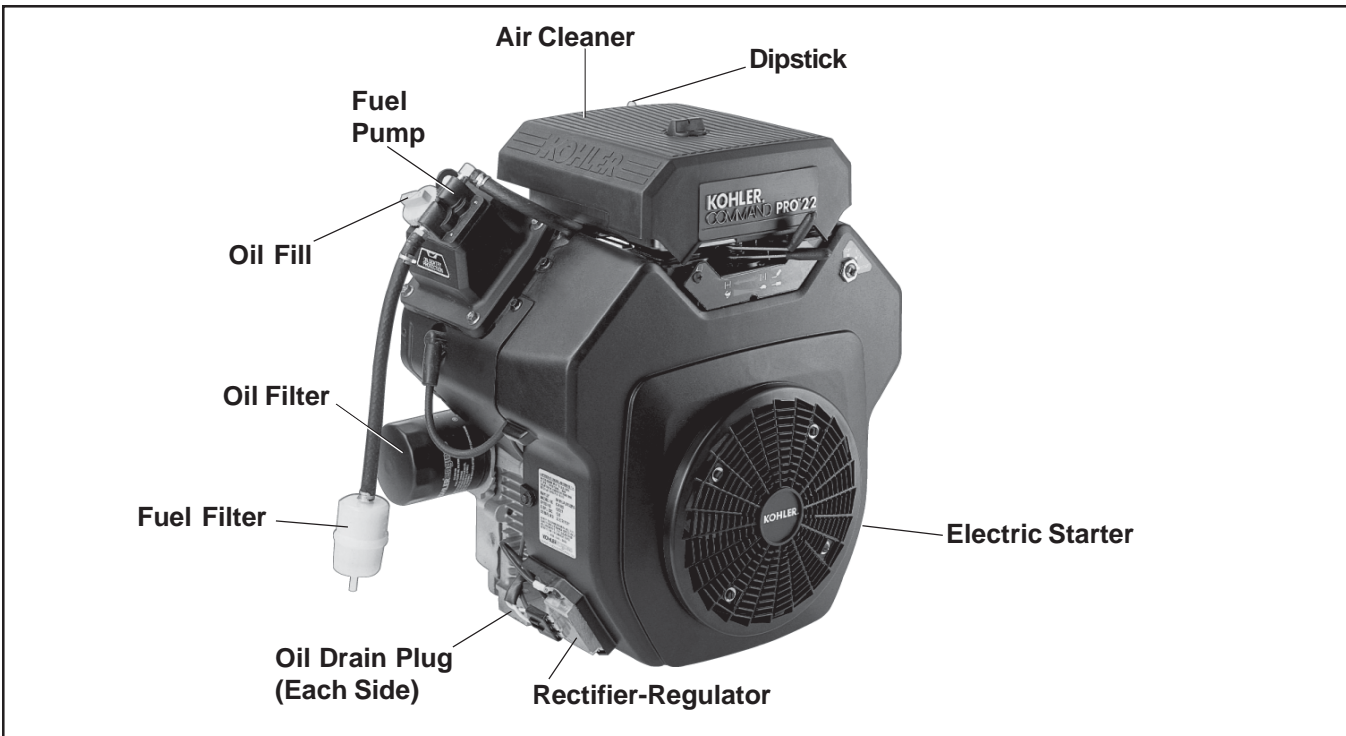

Figure 1. Typical Command Horizontal Shaft Carbureted Engine.

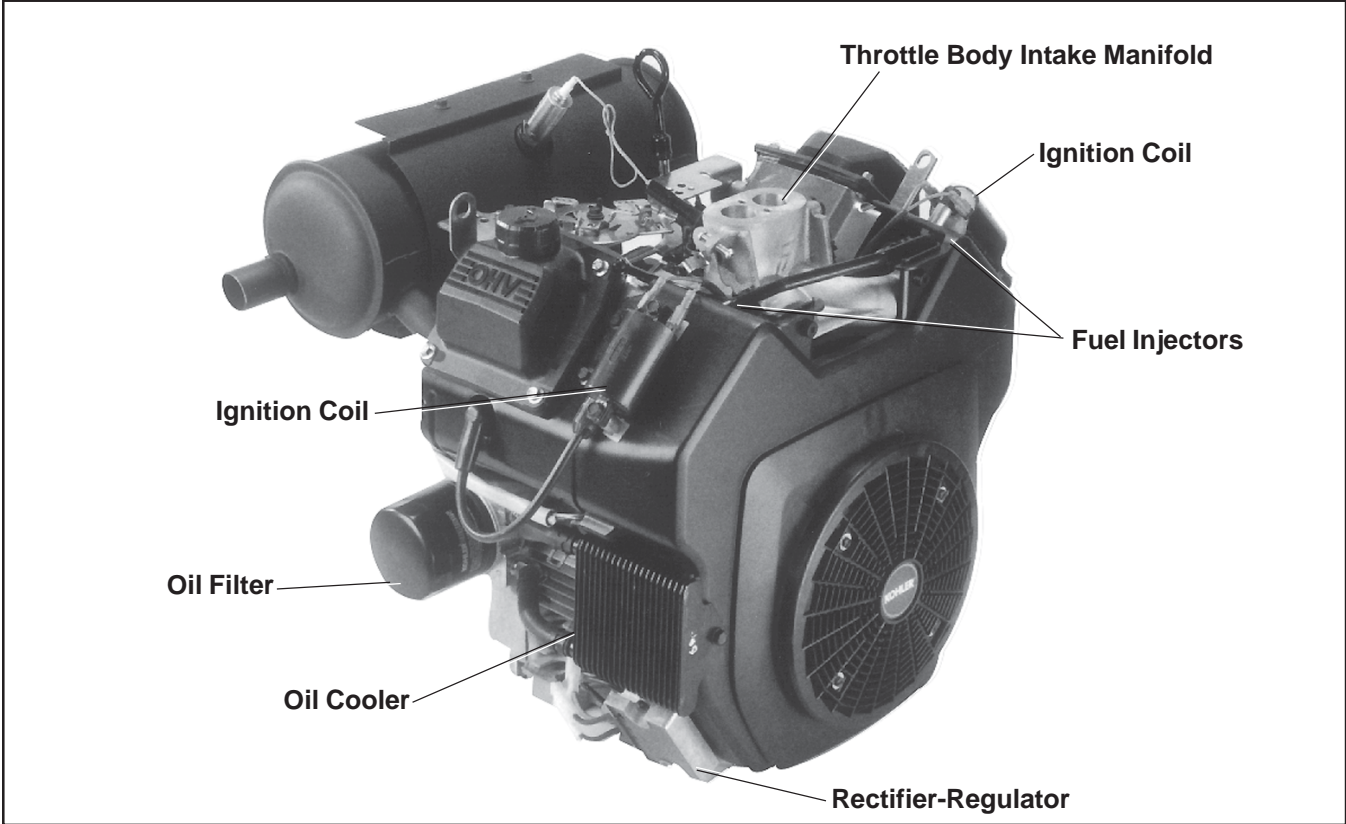

Figure 2. Typical Command Horizontal Shaft EFI Engine.

Oil Recommendations

Using the proper type and weight of oil in the crankcase is extremely important. So is checking oil daily and changing oil regularly. Failure to use the correct oil, or using dirty oil, causes premature engine wear and failure.

Oil Type

Use high quality detergent oil of API (American Petroleum Institute) service class SG, SH, SJ, or higher. Select the viscosity based on the air temperature at the time of operation as shown in the following table.

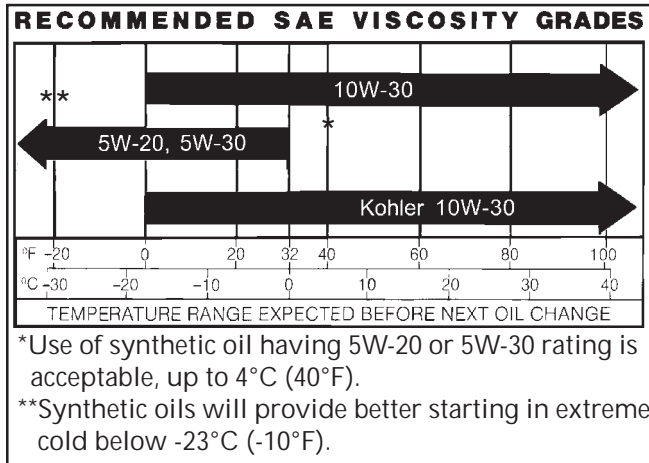

Figure 3. Viscosity Grades Table.

NOTE: Using other than service class SG, SH, SJ or higher oil or extending oil change intervals longer than recommended can cause engine damage.

NOTE: Synthetic oils meeting the listed classifications may be used with oil changes performed at the recommended intervals. However to allow piston rings to properly seat, a new or rebuilt engine should be operated for at least 50 hours using standard petroleum based oil before switching to synthetic oil.

A logo or symbol on oil containers identifies the API service class and SAE viscosity grade. See Figure 4.



Figure 4. Oil Container Logo.

Refer to Maintenance Instructions beginning on page 8 for detailed oil check, oil change, and oil filter change procedures.

Fuel Recommendations



WARNING: Explosive Fuel!

Gasoline is extremely flammable and its vapors can explode if ignited. Store gasoline only in approved containers, in well ventilated, unoccupied buildings, away from sparks or flames. Do not fill the fuel tank while the engine is hot or running, since spilled fuel could ignite if it comes in contact with hot parts or sparks from ignition. Do not start the engine near spilled fuel. Never use gasoline as a cleaning agent.

General Recommendations

Purchase gasoline in small quantities and store in clean, approved containers. A container with a capacity of 2 gallons or less with a pouring spout is recommended. Such a container is easier to handle and helps eliminate spillage during refueling.

Do not use gasoline left over from the previous season, to minimize gum deposits in fuel system and to ensure easy starting.

Do not add oil to the gasoline.

Do not overfill the fuel tank. Leave room for the fuel to expand.

Fuel Type

For best results use only clean, fresh, unleaded gasoline with a pump sticker octane rating of 87 or higher. In countries using the Research method, it should be 90 octane minimum.

Unleaded gasoline is recommended as it leaves less combustion chamber deposits and reduces harmful exhaust emissions. Leaded gasoline is not recommended and **must not** be used on EFI engines, or on other models where exhaust emissions are regulated.

Gasoline/Alcohol blends

Gasohol (up to 10% ethyl alcohol, 90% unleaded gasoline by volume) is approved as a fuel for Kohler engines. Other gasoline/alcohol blends including E20 and E85 are not to be used and not approved. Any failures resulting from use of these fuels will not be warranted.

Gasoline/Ether blends

Methyl Tertiary Butyl Ether (MTBE) and unleaded gasoline blends (up to a maximum of 15% MTBE by volume) are approved as a fuel for Kohler engines. Other gasoline/ether blends are not approved.

Engine Identification Numbers

When ordering parts, or in any communication involving an engine, always give the **Model, Specification, and Serial Numbers** of the engine.

The engine identification numbers appear on a decal affixed to the engine shrouding. Include letter suffixes, if there are any. Record your engine identification numbers on an identification label below (Figure 5) for future reference.

For Models CH18-CH745

KOHLER

IMPORTANT ENGINE INFORMATION
 THIS ENGINE MEETS U.S. EPA PH2 AND EC STAGE II (SN:4) EMISSION REGS FOR SI SORE NOT FOR SALE IN CALIFORNIA UNLESS PREEMPT PER SEC. 209(e)(1) of CAA

FAMILY
TYPE APP
DISPL (CC)
MODEL NO.  N11236
SPEC. NO.
SERIAL NO.
BUILD DATE

OEM PROD. NO.
 EMISSION COMPLIANCE PERIOD:
 EPA:
 CERTIFIED ON:
 REFER TO OWNER'S MANUAL FOR HP RATING, SAFETY, MAINTENANCE AND ADJUSTMENTS
 1-800-544-2444 KohlerEngines.com
 KOHLER CO. KOHLER, WISCONSIN USA

KOHLER

IMPORTANT ENGINE INFORMATION
 THIS ENGINE MEETS U.S. EPA PH2, EC STAGE II (SN:4) AND CA 2008 AND LATER EXH EMISSION REGS FOR SI SORE

FAMILY
TYPE APP
DISPL (CC)
MODEL NO.  N11236
SPEC. NO.
SERIAL NO.
BUILD DATE

OEM PROD. NO.
 EMISSION COMPLIANCE PERIOD:
 EPA: CARB:
 CERTIFIED ON:
 REFER TO OWNER'S MANUAL FOR HP RATING, SAFETY, MAINTENANCE AND ADJUSTMENTS
 1-800-544-2444 KohlerEngines.com
 KOHLER CO. KOHLER, WISCONSIN USA

For Model CH750

KOHLER

IMPORTANT ENGINE INFORMATION
 THIS ENGINE MEETS EMISSION REGS FOR U.S. EPA 2005 AND LATER AND EC STAGE II (SN:4) SI SMALL OFF-ROAD ENGINES AND CA 2005 AND LATER LSI ENGINES

FAMILY
TYPE APP
DISPL (CC)
MODEL NO.  N11236
SPEC. NO.
SERIAL NO.
BUILD DATE

OEM PROD. NO.
 EMISSION COMPLIANCE PERIOD:
 EPA:
 CERTIFIED ON:
 REFER TO OWNER'S MANUAL FOR HP RATING, SAFETY, MAINTENANCE AND ADJUSTMENTS
 1-800-544-2444 KohlerEngines.com
 KOHLER CO. KOHLER, WISCONSIN USA

The Emission Compliance Period referred to on the Emission Control or Air Index label indicates the number of operating hours for which the engine has been shown to meet Federal and CARB emission requirements. The following table provides the Engine Compliance Period (in hours) associated with the category descriptor found on the certification label.

Emission Compliance Period (Hours)

EPA	Category C 250 hours	Category B 500 hours	Category A 1000 hours
CARB	Moderate 125 hours	Intermediate 250 hours	Extended 500* hours

*Extended hours for Model CH750 is 1000.

Refer to certification label for engine displacement.

Exhaust Emission Control System for models CH18/CH620, CH20/CH640, CH23/CH680, CH730, CH740, CH750 is EM. Exhaust Emission Control System for models CH26/CH735 and CH745 are EM, O2S, ECM, MFI.

Model Designation

Model CH20S for example: C designates Command engine, H designates horizontal crankshaft, and 20 designates horsepower. Some model numbers (CH730) use a numerical designation rather than horsepower. A letter suffix designates a specific version as follows:

Suffix	Designates
S	Electric Start
ST	Electric Start/Retractable Start
QS	Quiet Model/Electric Start
EP	Electric Plant
CS	Clutch Model/Electric Start

Operating Instructions

Also read the operating instructions of the equipment this engine powers.

Pre-Start Checklist

- Check oil level. Add oil if low. Do not overfill.
- Check fuel level. Add fuel if low.
- Check cooling air intake areas and external surfaces of engine. Make sure they are clean and unobstructed.
- Check that the air cleaner components and all shrouds, equipment covers, and guards are in place and securely fastened.

Figure 5. Engine Identification Label.

- Check that any clutches or transmissions are disengaged or placed in neutral. This is especially important on equipment with hydrostatic drive. The shift lever must be exactly in neutral to prevent resistance which could keep the engine from starting.



WARNING: Lethal Exhaust Gases!

Engine exhaust gases contain poisonous carbon monoxide. Carbon monoxide is odorless, colorless, and can cause death if inhaled. Avoid inhaling exhaust fumes, and never run the engine in a closed building or confined area.

Cold Weather Starting Hints

1. Be sure to use the proper oil for the temperature expected. See Figure 3 on page 5.
2. Disengage all possible external loads.
3. Be sure the battery is in good condition. A warm battery has much more starting capacity than a cold battery.
4. Use fresh winter grade fuel. NOTE: Winter grade gasoline has higher volatility to improve starting. Do not use gasoline left over from summer.

Starting

1. Place the throttle control **midway** between the **slow** and **fast** positions. Place the choke control (non-EFI engines only) into the **on** position. See Figure 6.



Figure 6. Optional Engine Mounted Throttle and Choke Controls (Carbureted Engines).

2. Start the engine by activating the key switch. Release the switch as soon as the engine starts.

EFI Engines Only – Initial Starting or After Running out of Fuel (Dry System)

- a. Turn the key switch to the **on** position for one minute. Allow the fuel pump to cycle and prime the system. Turn the key switch **off**.
- b. Turn the key switch to the **start** position, crank and start engine.

- c. If the engine fails to start, repeat steps **a** and **b**. If the engine does not start after two priming intervals, contact your Kohler Engine Service Dealer for further assistance.

NOTE: Do not crank the engine continuously for more than 10 seconds at a time. If the engine does not start, allow a 60 second cool down period between starting attempts. Failure to follow these guidelines can burn out, or permanently damage, the starter motor.

NOTE: Upon start-up, a metallic ticking may occur. This is caused by hydraulic lifter leakdown during storage. Run the engine for 5 minutes. The noise will normally cease in the first minute. If noise continues, run the engine at mid-throttle for 20 minutes. If noise persists, take the engine to your local authorized Kohler Engine Service Dealer.

NOTE: If the engine develops sufficient speed to disengage the starter but does not keep running (a false start), engine rotation must be allowed to come to a complete stop before attempting to restart the engine. If the starter is engaged while the flywheel is rotating, the starter pinion and flywheel ring gear may clash resulting in damage to the starter.

If the starter does not turn the engine over, shut off starter immediately. Do not make further attempts to start the engine until the condition is corrected. Do not jump start using another battery (refer to **Battery** on page 8). See your Kohler Engine Service Dealer for service assistance.

Carbureted Engines Only:

3. For a **Cold Engine** – Gradually return the choke control to the **off** position after the engine starts and warms up.

The engine/equipment may be operated during the warm-up period, but it may be necessary to leave the choke partially on until the engine warms up.

4. For a **Warm Engine** – Return choke to **off** position as soon as engine starts.

Stopping

1. Remove the load by disengaging all PTO driven attachments.
2. **For Carbureted Engines Without A Shutdown Solenoid:** Move the throttle to the **slow** or **low** idle position. Allow the engine to run at idle for 30-60 seconds; then stop the engine.

For Carbureted Engines Equipped With A Shutdown Solenoid: Position the throttle control somewhere between half and full throttle; then stop the engine.

For EFI Engines: Move the throttle to the **slow** or **idle** position; turn key **off** to stop engine.

Battery

A 12 volt battery is normally used. Refer to the operating instructions of the equipment this engine powers for specific battery requirements.

If the battery charge is not sufficient to crank the engine, recharge the battery (see page 13).

Operating

Angle of Operation

This engine will operate continuously at angles up to 25°. Check oil level to assure crankcase oil level is at the "F" mark on the dipstick.

Refer to the operating instructions of the equipment this engine powers. Because of equipment design or application, there may be more stringent restrictions regarding the angle of operation.

NOTE: Do not operate this engine continuously at angles exceeding 25° in any direction. Engine damage could result from insufficient lubrication.

Cooling

NOTE: If debris builds up on the grass screen or other cooling air intake areas, stop the engine immediately and clean. Operating the engine with blocked or dirty air intake and cooling areas can cause extensive damage due to overheating.



WARNING: Hot Parts!

Engine components can get extremely hot from operation. To prevent severe burns, do not touch these areas while the engine is running, or immediately after it is turned off. Never operate the engine with heat shields or guards removed.

Engine Speed

NOTE: Do not tamper with the governor setting to increase the maximum engine speed. Overspeed is hazardous and will void the engine warranty. The maximum allowable high idle speed for these engines is 3750 RPM, no load.

Maintenance Instructions

Maintenance, repair, or replacement of the emission control devices and systems, which are being done at the customers expense, may be performed by any non-road engine repair establishment or individual. Warranty repairs must be performed by an authorized Kohler service outlet.



WARNING: Accidental Starts!

Disabling engine. Accidental starting can cause severe injury or death. Before working on the engine or equipment, disable the engine as follows: 1) Disconnect the spark plug lead(s). 2) Disconnect negative (-) battery cable from battery.

Maintenance Schedule

These required maintenance procedures should be performed at the frequency stated in the table. They should also be included as part of any seasonal tune-up.

Frequency	Maintenance Required
Daily or Before Starting Engine	<ul style="list-style-type: none"> • Fill fuel tank. • Check oil level. • Check air cleaner for dirty¹, loose, or damaged parts. • Check air intake and cooling areas, clean as necessary¹.
Every 25 Hours	<ul style="list-style-type: none"> • Service precleaner element¹.
Every 100 Hours	<ul style="list-style-type: none"> • Replace air cleaner element¹. • Change oil. (More frequently under severe conditions.) • Remove cooling shrouds and clean cooling areas^{1,3}. • Check oil cooler fins, clean as necessary (if equipped).
Every 200 Hours	<ul style="list-style-type: none"> • Check spark plug condition and gap. • Change oil filter. • Replace fuel filter (carbureted engines).
Every 250 Hours	<ul style="list-style-type: none"> • Replace heavy-duty air cleaner element and check inner element¹.
Annually or Every 500 Hours	<ul style="list-style-type: none"> • Have bendix starter drive serviced^{2,4}. • Have solenoid shift starter disassembled and cleaned^{2,4}.
Every 500 Hours	<ul style="list-style-type: none"> • Have crankshaft spline lubricated².
Every 1500 Hours	<ul style="list-style-type: none"> • Replace fuel filter¹ (EFI engines).

¹Perform these maintenance procedures more frequently under extremely dusty, dirty conditions.

²Have a Kohler Engine Service Dealer perform this service.

³Cleanout Kits 25 755 20-S (black) or 25 755 21-S (gold) allow cooling areas to be cleaned without removing shrouds.

⁴Only required for Denso starters. Not necessary on Delco starters.

Check Oil Level

The importance of checking and maintaining the proper oil level in the crankcase cannot be overemphasized. Check oil **BEFORE EACH USE** as follows:

1. Make sure the engine is stopped, level, and is cool so the oil has had time to drain into the sump.
2. To keep dirt, debris, etc., out of the engine, clean the area around the dipstick before removing it.
3. Remove the dipstick; wipe oil off. Reinsert the dipstick into the tube and press all the way down.
4. Remove the dipstick and check the oil level. The oil level should be up to, but not over, the "F" mark on the dipstick. See Figure 7.

5. If the level is low, add oil of the proper type, up to the "F" mark on the dipstick. (Refer to Oil Type on page 5.) Always check the level with the dipstick before adding more oil.

NOTE: To prevent extensive engine wear or damage, always maintain the proper oil level in the crankcase. Never operate the engine with the oil level below the "L" mark or over the "F" mark on the dipstick.

Oil Sentry™

Some engines are equipped with an optional Oil Sentry™ oil pressure switch. If the oil pressure decreases below an acceptable level, the Oil Sentry™ will either shut off the engine or activate a warning signal, depending on the application.

NOTE: Make sure the oil level is checked **BEFORE EACH USE** and is maintained up to the "F" mark on the dipstick. This includes engines equipped with Oil Sentry™.

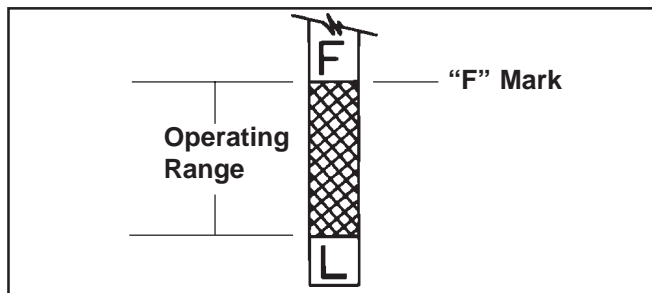

Figure 7. Oil Level Dipstick.

Change Oil and Filter, Service Oil Cooler

Change Oil

Change oil after every **100 hours** of operation (more frequently under severe conditions). Refill with service class SG, SH, SJ or higher oil as specified in the Viscosity Grades table (Figure 3) on page 5.

Change the oil while the engine is still warm. The oil will flow more freely and carry away more impurities. Make sure the engine is level when filling, checking, and changing the oil.

Change the oil as follows (see Figures 8 and 9):

1. To keep dirt, debris, etc., out of the engine, clean the area around the oil fill cap/dipstick before removing it.
2. Remove one of the oil drain plugs, oil fill cap, and dipstick. Be sure to allow ample time for complete drainage.
3. Reinstall the drain plug. Make sure it is tightened to **13.6 N-m (10 ft. lb.)** torque.
4. Fill the crankcase, with new oil of the proper type, to the "F" mark on the dipstick. Refer to Oil Type on page 5. Always check the level with the dipstick before adding more oil.
5. Reinstall the oil fill cap and tighten securely. Reinstall dipstick.

NOTE: To prevent extensive engine wear or damage, always maintain the proper oil level in the crankcase. Never operate the engine with the oil level below the "L" mark or over the "F" mark on the dipstick.

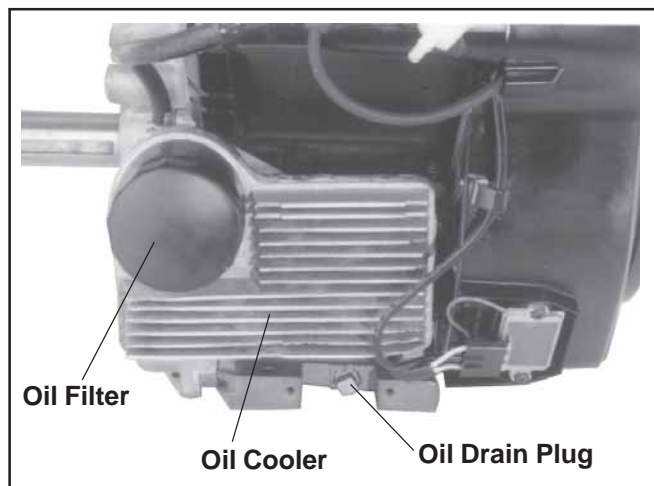

Figure 8. Oil Drain Plugs, Oil Filter, and Oil Cooler (Crankcase Mounted).

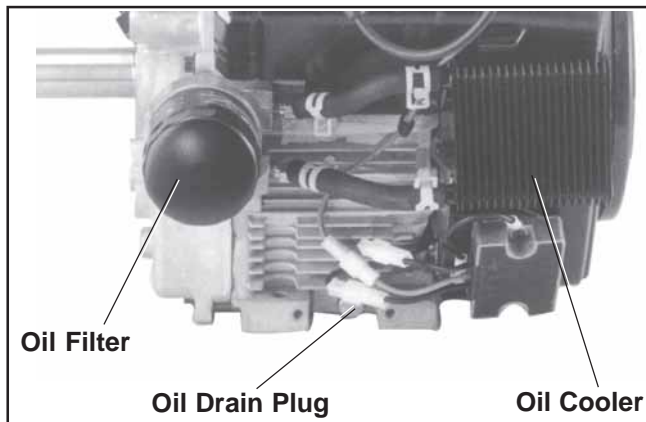

Figure 9. Oil Drain Plugs, Oil Filter, and Oil Cooler (Blower Housing Mounted).

Change Oil Filter

Replace the oil filter **at least every other oil change (every 200 hours of operation)**. Always use a genuine Kohler oil filter. Use chart below to determine part number to order.

Oil Filter Part No.	Length
12 050 01-S	2-1/2"
52 050 02-S	3-3/8"

Replace the oil filter as follows:

1. Drain the oil from the engine crankcase.
2. Allow the oil filter to drain.
3. Before removing the oil filter, clean the area around the oil filter to keep dirt and debris out of the engine. Remove the old filter. Wipe off the surface where the oil filter mounts.
4. Place a new replacement filter in a shallow pan with the open end up. Pour new oil, of the proper type, in through the threaded center hole. Stop pouring when the oil reaches the bottom of the threads. Allow a minute or two for the oil to be absorbed by the filter material.
5. Apply a thin film of clean oil to the rubber gasket on the new filter.
6. Install the replacement oil filter to the filter adapter or oil cooler. Turn the oil filter clockwise until the rubber gasket contacts the filter adapter or oil cooler, then tighten the filter an additional **3/4 to 1 turn**.
7. Reinstall the drain plug. Make sure it is tightened to **13.6 N-m (10 ft. lb.)** torque.
8. Fill the crankcase with new oil of the proper type to the "F" mark on the dipstick.

- Start the engine and check for oil leaks. Correct any leaks before placing the engine into service. Check oil level to be sure it is up to but not over the "F" mark.

Service Oil Cooler

Some engines are equipped with an oil cooler. One style of oil cooler mounts on the engine crankcase and has the oil filter on it (See Figure 8). The other style of oil cooler is mounted on the blower housing (see Figure 9), separate from the oil filter.

Inspect and clean the oil cooler every 100 hours of operation (more frequently under severe conditions). Oil cooler must be kept free of debris.

To service the crankcase mounted oil cooler clean off the outside fins with a brush or with compressed air.

To service the blower housing mounted oil cooler, clean the outside of fins with a brush. Remove the two screws holding the cooler unit to the blower housing. Tilt the cooler downward as shown in Figure 10. Clean the inside of cooler with a brush as shown in Figure 10 or with compressed air. After cleaning, reinstall oil cooler to blower housing with two mounting screws.



Figure 10. Cleaning Oil Cooler.

Service Precleaner and Air Cleaner Element

This engine is equipped with a replaceable, high density paper air cleaner element. Most engines are also equipped with an oiled, foam precleaner which surrounds the paper element. See Figure 11. Some engines use the heavy-duty air cleaner system. See Figure 13.

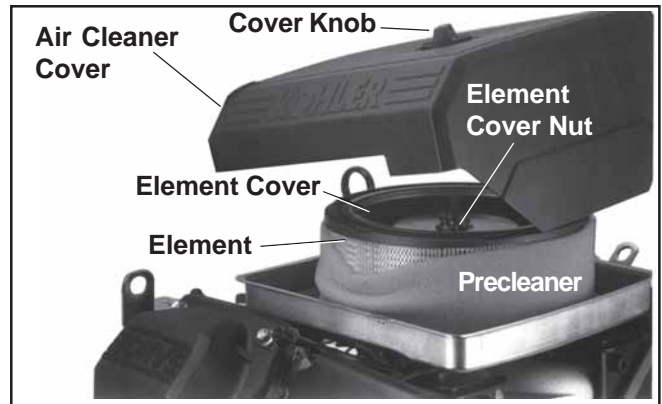

Figure 11. Air Cleaner System Components.

Check the air cleaner daily or before starting the engine. Check for a buildup of dirt and debris around the air cleaner system. Keep this area clean. Also check for loose or damaged components. Replace all bent or damaged air cleaner components.

NOTE: Operating the engine with loose or damaged air cleaner components could allow unfiltered air into the engine causing premature wear and failure.

Service Precleaner

If so equipped, wash and reoil the precleaner every 25 hours of operation (more often under extremely dusty or dirty conditions).

- Loosen the cover retaining knob and remove the cover.
- Remove the precleaner from the paper element.
- Wash the precleaner in warm water with detergent. Rinse the precleaner thoroughly until all traces of detergent are eliminated. Squeeze out excess water (do not wring). Allow the precleaner to air dry.
- Saturate the precleaner with new engine oil. Squeeze out all excess oil.
- Reinstall the precleaner over the paper element.
- Reinstall the air cleaner cover. Secure cover with the cover retaining knob.
- When precleaner replacement is necessary, order genuine Kohler parts.

24 083 02-S	61 mm (2.40 in.) high x 173 mm (6.81 in.) O.D.
24 083 05-S	71 mm (2.79 in.) high x 173 mm (6.81 in.) O.D.

Service Paper Element

Every **100 hours** of operation (more often under extremely dusty or dirty conditions) replace the paper element.

1. Loosen the cover retaining knob and remove the cover.
2. Remove the element cover nut, element cover, and paper element with precleaner.
3. Remove the precleaner (if so equipped) from the paper element. Service the precleaner as described above.
4. **Do not wash the paper element or use pressurized air**, as this will damage the element. Replace a dirty, bent, or damaged element with a genuine Kohler element. Handle new elements carefully; do not use if the sealing surfaces are bent or damaged.
5. When servicing the air cleaner, check the air cleaner base. Make sure it is secured and not bent or damaged. Also, check the element cover for damage or improper fit. Replace all damaged air cleaner components.

NOTE: If any loose dirt or debris fell on the air cleaner base when the element was removed, carefully remove it and wipe the base clean. Be careful that none of it drops into the intake throat. Check the condition of the rubber seal on the air cleaner stud. If the condition is questionable in any way, replace it with the new seal packaged with the replacement element.

6. Reinstall the paper element, precleaner, element cover, element cover nut, and air cleaner cover. Secure cover with the cover retaining knob.
7. When element replacement is necessary, order genuine Kohler parts.

47 083 03-S	65 mm (2.55 in.) high x 178 mm (7.00 in.) O.D.
24 083 03-S	74 mm (2.91 in.) high x 178 mm (7.00 in.) O.D.

Heavy-Duty Air Cleaner

To Service

Every **250 hours** of operation (more often under extremely dusty or dirty conditions), replace the paper element and check inner element. Follow these steps.

1. Unhook the two retaining clips and remove the end cap from the air cleaner housing.

2. Pull the air cleaner element out of the housing. See Figure 12.

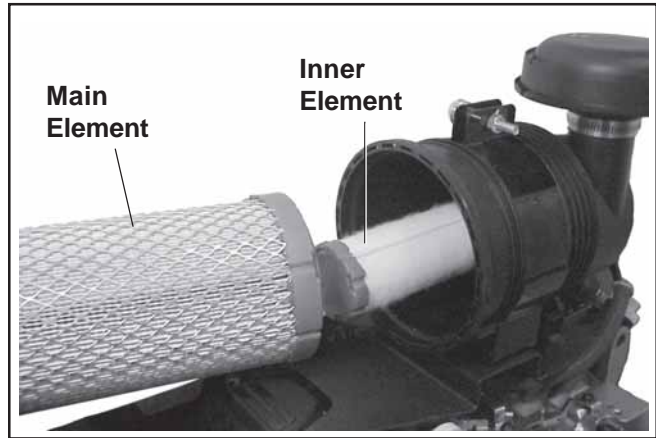

Figure 12. Removing Elements.

3. After the main element is removed, check the condition of the inner element. It should be replaced whenever it appears dirty, typically every other time the main element is replaced. Clean the area around the base of the inner element before removing it, so dirt does not get into the engine.
4. **Do not wash the paper element and inner element or use pressurized air**, this will damage the elements. Replace dirty, bent or damaged elements with new genuine Kohler elements as required. Handle new elements carefully; do not use if the sealing surfaces are bent or damaged.
5. Check all parts for wear, cracks, or damage. Replace any damaged components.
6. Install the new inner element, Kohler Part No. **25 083 04-S** followed by the outer element, Kohler Part No. **25 083 01-S**. Slide each fully into place in the air cleaner housing.
7. Reinstall the end cap so the dust ejector valve is down and secure with the two retaining clips. See Figure 13.

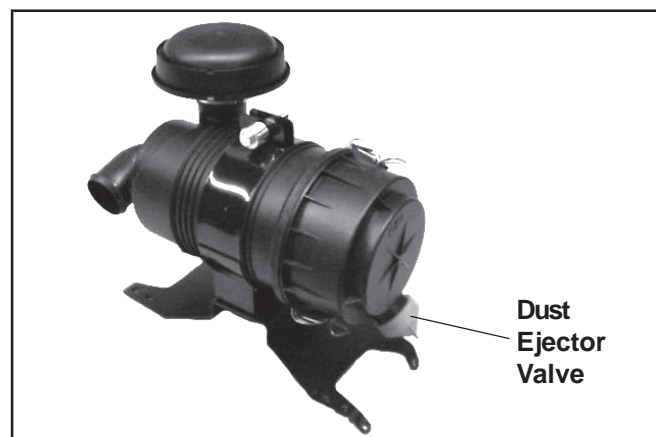

Figure 13. Heavy-Duty Air Cleaner Assembly.

Clean Air Intake/Cooling Areas

To ensure proper cooling, make sure the grass screen, cooling fins, and other external surfaces of the engine are kept clean **at all times**.

Every **100 hours** of operation (more often under extremely dusty, dirty conditions), remove the blower housing* and other cooling shrouds. Clean the cooling fins and external surfaces as necessary. Make sure the cooling shrouds are reinstalled.

NOTE: Operating the engine with a blocked grass screen, dirty or plugged cooling fins, and/or cooling shrouds removed, will cause engine damage due to overheating.

*Cleanout kits 25 755 20-S (black) or 25 755 21-S (gold) allow inspection and cleanout of the cooling fins, without removing the blower housing.

Ignition System

Carbureted Engines - Use an electronic Capacitive Discharge (CD) ignition system. Other than periodically checking/replacing the spark plugs, no maintenance, timing, or adjustments are necessary or possible with this system.

EFI Engines - Incorporate a computer-controlled battery ignition system with individual coils. Other than periodically checking/replacing the spark plugs, no maintenance, timing, or adjustments are necessary or possible with this system.

Check Spark Plugs

Every **200 hours** of operation, remove the spark plugs, check condition, and reset the gap or replace with new plugs as necessary. The standard spark plug is a Champion® RC12YC (Kohler Part No. 12 132 02-S). RFI complaint engines use a Champion® XC12YC (Kohler Part No. 25 132 14-S) spark plug. A high-performance spark plug, Champion® Platinum 3071 (used on Pro Series engines, Kohler Part No. 25 132 12-S) is also available. Equivalent alternate brand plugs can also be used.

1. Before removing the spark plug, clean the area around the base of the plug to keep dirt and debris out of the engine.
2. Remove the plug and check its condition. Replace the plug if worn or reuse is questionable.

NOTE: Do not clean the spark plug in a machine using abrasive grit. Some grit could remain in the spark plug and enter the engine causing extensive wear and damage.

3. Check the gap using a wire feeler gauge. Adjust the gap to **0.76 mm (0.030 in.)** by carefully bending the ground electrode. See Figure 14.

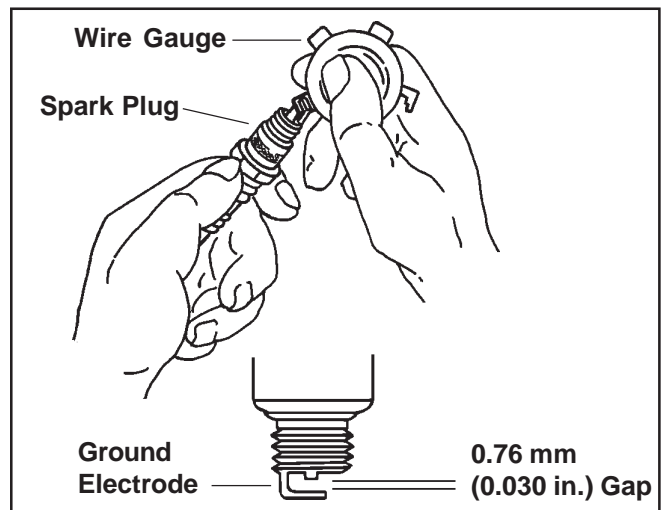

Figure 14. Servicing Spark Plug.

4. Reinstall the spark plug into the cylinder head. Torque the spark plug to **24.4-29.8 N·m (18-22 ft. lb.)**.

Battery Charging



WARNING: Explosive Gas!

Batteries produce explosive hydrogen gas while being charged. To prevent a fire or explosion, charge batteries only in well ventilated areas. Keep sparks, open flames, and other sources of ignition away from the battery at all times. Keep batteries out of the reach of children. Remove all jewelry when servicing batteries.

Before disconnecting the negative (-) ground cable, make sure all switches are OFF. If ON, a spark will occur at the ground cable terminal which could cause an explosion if hydrogen gas or gasoline vapors are present.

NOTE: Do not apply 12 volt DC to kill terminal of ignition module.

Fuel System



WARNING: Fuel System Under Pressure!

The EFI fuel system operates under high pressure, and the fuel filter and fuel line used must be approved system components only. Use of substitute parts can result in system failure, gasoline leakage and possible explosion.

Fuel Filter

Carbureted Engines: Most engines are equipped with an in-line fuel filter. Periodically inspect the filter and replace with a genuine Kohler filter every **200 operating hours**.

EFI Engines: A special, high volume, high pressure filter with greater filtration capabilities and internal surface area is used. See Figure 15.

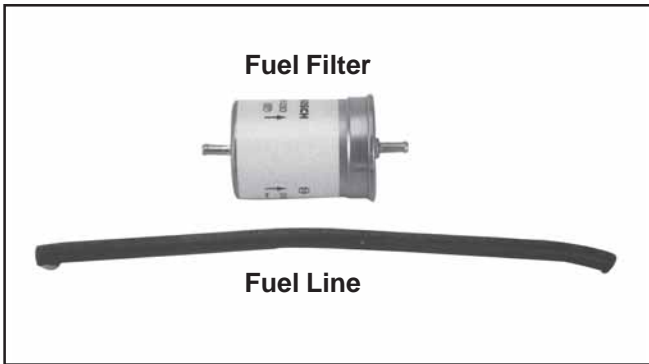

Figure 15. EFI Fuel Filter and Line.

Replacement is recommended every **1500 hours**, or more frequently under extremely dusty or dirty conditions. When replacement is necessary, always use genuine Kohler parts.

Fuel Line

Carbureted Engines: In compliance with CARB Tier III Emission Regulations, carbureted engines with a **Family** identification number beginning with "6" or greater (see Figure 16), must use Low Permeation SAE 30 R7 rated fuel line; certified to meet CARB requirements. Standard fuel line may not be used. Order replacement hose by part number through a Kohler Engine Service Dealer.

KOHLER

IMPORTANT ENGINE INFORMATION
THIS ENGINE MEETS U.S. EPA AND CA 2005 AND LATER AND EC STAGE II (SN:4) EMISSION REGS FOR SI SMALL OFF-ROAD ENGINES

FAMILY 6 KHXS.XXXX PH

TYPE APP

DISPL. (CC)

MODEL NO. N11236

SPEC. NO.

SERIAL NO.

BUILD DATE

OEM PROD. NO.

EMISSION COMPLIANCE PERIOD:
EPA: CARB:

CERTIFIED ON:
REFER TO OWNER'S MANUAL FOR HP RATING, SAFETY, MAINTENANCE AND ADJUSTMENTS
1-800-544-2444 www.kohlerengines.com

KOHLER CO. KOHLER, WISCONSIN USA

Figure 16. Family Number Location.

EFI Engines: A special fuel line, capable of withstanding the high pressure of the EFI fuel system, is used (must meet SAE R9 specifications). See Figure 15. If fuel line must be replaced, see your Kohler Engine Service Dealer.

Carburetor Troubleshooting and Adjustments

Engines in this series use either a one- or two-barrel carburetor depending on model, and may also be equipped with a Governed Idle System. Specific adjustment procedures are provided based on the model and carburetor involved. If the engine is equipped with a Governed Idle System, refer to **Models with Governed Idle System** on page 15 when performing any carburetor adjustment, as an additional step to the listed adjustment procedure(s) is required.

NOTE: Carburetor adjustments should be made only after the engine has warmed up.

The carburetor is designed to deliver the correct fuel-to-air mixture to the engine under all operating conditions. To comply with current emission regulations, the fuel mixture settings are made at the factory and cannot be adjusted.

NOTE: To ensure correct engine operation at altitudes above 1525 meters (5000 ft.), it may be necessary to have an authorized Kohler dealer install a special high-altitude jet kit in the carburetor. If a high-altitude kit has been installed, the engine must be reconverted to the original jet size, before it is operated at lower altitudes, or overheating and engine damage can result.

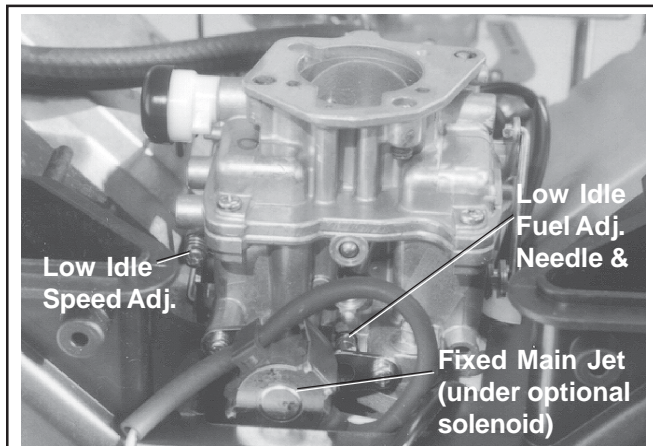

Figure 17. Carburetor (CH18-23, CH620-CH730, CH740).

Troubleshooting

If engine troubles are experienced that appear to be fuel system related, check the following areas before adjusting the carburetor.

- Make sure the fuel tank is filled with clean, fresh gasoline.
- Make sure the fuel tank cap vent is not blocked and that it is operating properly.

- If the fuel tank is equipped with a shut-off valve, make sure it is open.
- If the engine is equipped with an in-line fuel filter, make sure it is clean and unobstructed. Replace the filter if necessary.
- Make sure fuel is reaching the carburetor. This includes checking the fuel lines and fuel pump for restrictions or faulty components, replace as necessary.
- Make sure the air cleaner element is clean and all air cleaner element components are fastened securely.

If, after checking the items listed above, the engine is hard to start, runs roughly, or stalls at low idle speed, it may be necessary to adjust or service the carburetor.

Adjust Carburetor

Models CH18-740

There are no accessible mixture adjustment screws on the carburetor. The only setting which can be changed is the low idle speed.

1. Start the engine and run at half throttle for 5 to 10 minutes to warm up. The engine must be warm before making final settings (steps 2 and 3).
2. **Low Idle Speed Setting:** Place the throttle control into the **idle** or **slow** position. Set the low idle speed to **1200 RPM*** (± 75 RPM) by turning the low idle speed adjusting screw **in** or **out**. Check the speed using a tachometer.

*NOTE: The actual low idle speed depends on the application – refer to equipment manufacturers recommendations. The standard low idle speed is 1200 RPM.

3. If proper operation is not restored after adjusting the low idle speed, carburetor servicing by an authorized Kohler Engine Service Dealer may be required.

Models with Governed Idle System

An optional governed idle control system is supplied on some CH18-740 engines. The purpose of this system is to maintain a desired idle speed regardless of ambient conditions (temperature, parasitic load, etc.) that may change. Engines with this feature contain a small secondary spring connected between the governor lever and the lower adjustment tab of the main bracket. See Figure 18.

The system requires an additional procedure for setting the idle speed. If speed adjustments are required proceed as follows.

1. Make any necessary speed or control adjustments following the appropriate instructions covered in this section.
2. Move the throttle control to the idle position. Hold the governor lever away from the carburetor, or hold the throttle lever so it is tight against the idle speed adjusting screw, to negate the governor activation. See Figure 19. Check the speed with a tachometer and adjust it to 1500 RPM.
3. Release the governor lever and allow the engine to return to the governed idle speed. Check it with a tachometer against the equipment manufacturers recommended idle speed. Governed Idle Speed (RPM) is typically 300 RPM (approximate) higher than the low idle speed. If adjustment is necessary, bend the adjusting tab on the speed control assembly to set. See Figure 18.

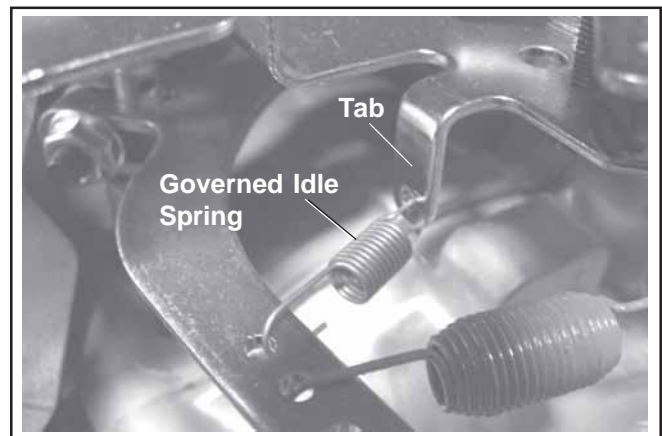

Figure 18. Governed Idle Spring Location.

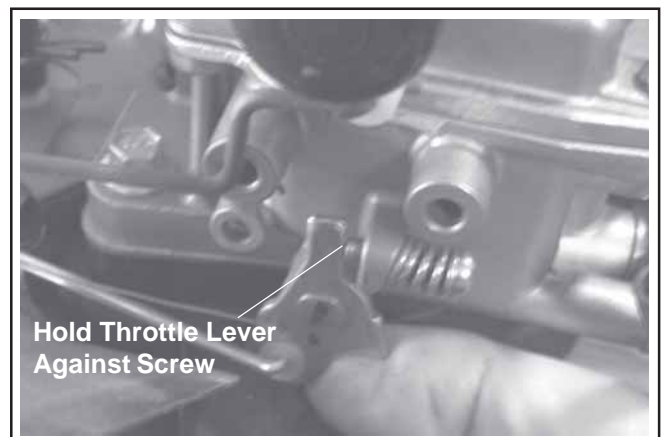

Figure 19. Holding Throttle Lever Against Idle Stop Screw.

Model CH750

CH750 engines use a Keihin BK two-barrel carburetor with fixed main jets and fixed or limiter-equipped low idle fuel adjusting needles. See Figure 20. Adjustments are made as follows.

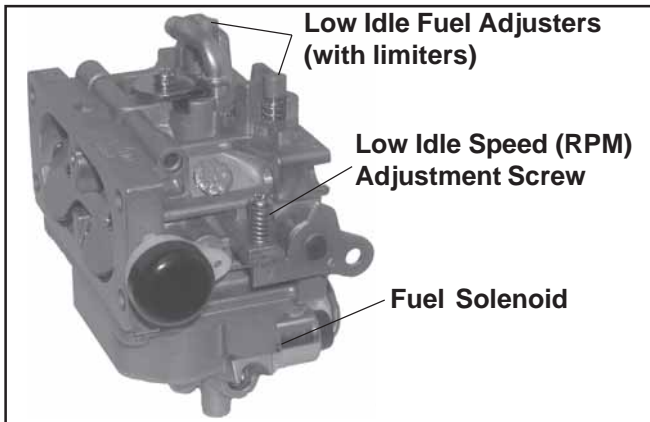

Figure 20. Keihin Two-Barrel Carburetor.

Low Idle Speed (RPM) Adjustment

1. **Low Idle Speed (RPM) Setting:** Place the throttle control into the **idle** or **slow** position. Set the low idle speed to **1200 RPM*** (± 75 RPM) by turning the low idle speed adjusting screw **in** or **out**. Check the speed using a tachometer.

*NOTE: The actual low idle speed depends on the application. Refer to the equipment manufacturer's recommendations. The low idle speed for basic engines is 1200 RPM. To ensure best results when setting the low idle fuel needle, the low idle speed should be 1200 RPM (± 75 RPM).

Low Idle Fuel Adjustment

NOTE: Engines will have fixed low idle or limiter caps on the two idle fuel adjusting needles. Step 3 can only be performed within the limits allowed by the cap. Do not attempt to remove the limiter caps.

1. Start the engine and run at half throttle for 5 to 10 minutes to warm up. The engine must be warm before doing steps 2, 3, and 4.
2. Place the throttle control into the **idle** or **slow** position. Adjust the low idle speed to **1200 RPM***. Follow the **Adjusting the Low Idle Speed (RPM)** procedure.
3. **Low Idle Fuel Needle(s) Setting:** Place the throttle into the **idle** or **slow** position.
 - a. Turn one of the low idle fuel adjusting needles out (counterclockwise) from the preliminary setting until the engine speed decreases (rich). Note the position of the needle. Now turn the

adjusting needle in (clockwise). The engine speed may increase, then it will decrease as the needle is turned **in** (lean). Note the position of the needle. Set the adjusting needle midway between the rich and lean settings. See Figure 21.

- b. Repeat the procedure on the other low idle adjustment needle.
4. Recheck/adjust the **Low Idle Speed (RPM)**, to the specified setting.

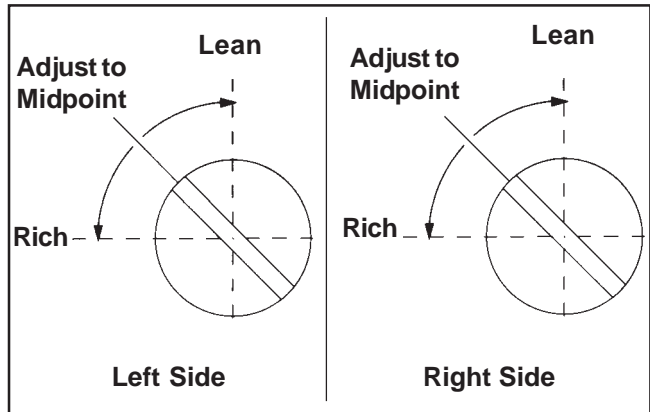

Figure 21. Optimum Low Idle Fuel Settings.

Models with Governed Idle System

An optional governed idle control system is supplied on some CH750 engines. The purpose of this system is to maintain a desired idle speed regardless of ambient conditions (temperature, parasitic load, etc.) that may change. Engines with this feature contain a small secondary spring connected between the governor lever and the lower adjustment tab of the main bracket. See Figure 18. Refer to the same adjustment procedure covered in **Models with Governed Idle System** for the CH18-740 models on page 15, when adjustments are required.

Electronic Fuel Injection (EFI) System

The EFI system is a complete, electronically-controlled fuel management system, designed to deliver a precisely controlled fuel flow under all operating conditions. The electronic control unit (ECU), the **brain** of the system, automatically adjusts fuel delivery and ignition timing based upon load, speed, operating temperature, and exhaust emission levels. The low idle speed is the only manual adjustment possible.

The ECU continuously monitors operation of the EFI system. If it detects a problem or fault within the system, it will illuminate the malfunction indicator light (MIL), which is mounted in view of the operator. This is a signal that normal, programmed operation has been affected, and service by an authorized Kohler Engine Dealer is required.

NOTE: The EFI system requires a rather complex wiring harness to carry the electrical signals between the sensors and the ECU. **Do not** spray water at the wiring harness or any of the electrical components, especially the ECU, as it could cause malfunction, damage, or failure.

Troubleshooting

If the MIL comes on, or the engine becomes hard to start, runs roughly, or stalls at low idle speed, initial checks should be made in the following areas:

- Make sure the fuel tank is filled with clean, fresh gasoline, and shut-off valve (if so equipped) is opened completely.
- Make sure fuel tank vent cap is not blocked and it is operating properly.
- Make sure the air cleaner element and precleaner are clean and all components are properly secured. Clean or replace as necessary.
- Make sure the proper fuel filter is being used, and it is clean and unobstructed. Replace filter **only** with genuine Kohler parts.
- Make sure all connections to sensors, ECU, and fuel injectors are properly secured.
- Make sure a good 12 volt battery is being used and is fully charged.

If these checks do not correct the problem, or the MIL remains on, further diagnosis and servicing by an authorized Kohler Engine Dealer is necessary.

Adjustment – EFI Throttle Body

Low Idle Speed (RPM) is the only adjustment that can be made. All other fuel calibrations are permanently preset and controlled by the ECU. The standard low idle speed is **1500 RPM*** (+ 75 RPM).

*NOTE: The actual low idle speed depends on the application -- refer to equipment manufacturer's recommendations.

When an EFI engine is started cold, the ECU will be using internal programming for cold running, and the idle speed may vary from the manual setting. Do not attempt to perform any readjustment during this warm-up period.

If adjustment is to be made, the engine must be at operating temperature, air cleaner in place, and check engine light must be off (no fault codes present).

1. Start the engine and run at half throttle for 5 to 10 minutes to warm up.
2. Place the throttle control into the **idle** or **slow** position.
3. Turn the low idle speed adjusting screw in or out and check RPM with a tachometer. See Figure 22.

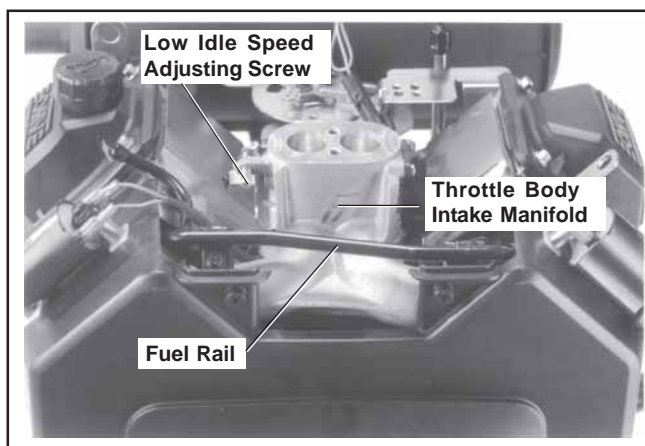

Figure 22. EFI Throttle Body Manifold.

Troubleshooting

When troubles occur, be sure to check the simple causes which, at first, may seem too obvious to be considered. For example, a starting problem could be caused by an empty fuel tank. Some common causes of engine troubles are listed in the following table.

Do not attempt to service or replace major engine components, or any items that require special timing or adjustment procedures. Have your Kohler Engine Service Dealer do this work.

Possible Cause Problem	No Fuel	Improper Fuel	Dirt In Fuel Line/System	Dirty Grass Screen	Incorrect Oil Level	Engine Overloaded	Dirty Air Cleaner	Faulty Spark Plug
Will Not Start	•	•	•		•	•	•	•
Hard Starting		•	•		•	•	•	•
Stops Suddenly	•		•	•	•	•	•	
Lacks Power		•	•	•	•	•	•	•
Operates Erratically		•	•	•		•	•	•
Knocks or Pings		•		•		•		•
Skips or Misfires		•	•	•			•	•
Backfires			•			•	•	•
Overheats			•	•	•	•	•	
High Fuel Consumption						•	•	•

Storage

If the engine will be out of service for two months or more, use the following storage procedure:

1. Clean the exterior surfaces of the engine. On EFI engines, avoid spraying water at the wiring harness or any of the electrical components.
2. Change the oil and filter while the engine is still warm from operation. See Change Oil and Filter on page 10.
3. The fuel system must be completely emptied, or the gasoline must be treated with a stabilizer to prevent deterioration. If you choose to use a stabilizer, follow the manufacturers recommendations, and add the correct amount for the capacity of the fuel system. Fill the fuel tank with clean, fresh gasoline. Run the engine for 2-3 minutes to get stabilized fuel into the rest of the system. Close fuel shut-off valve when unit is being stored or transported.

To empty the system, run the engine until the tank and fuel system are empty.

4. Remove the spark plugs. Add one tablespoon of engine oil into each spark plug hole. Install the plugs, but do not connect the plug leads. Crank the engine two or three revolutions.

Specifications

Model:	CH18/CH620	CH20/CH640	CH23/CH680
Bore:	77 (3.03)	77 (3.03)	80 (3.2)
Stroke:	67 (2.64)	67 (2.64)	67 (2.64)
Displacement:	624 (38.1)	624 (38.1)	674 (41)
Power (@ 3600 RPM):	13.4 (18*)	14.9 (20*)	17.2 (23*)
Compression Ratio:	8.5:1	8.5:1	8.5:1
Weight:	41 (90)	41 (90)	41 (90)
Oil Capacity (w/filter) - approximate, determined by oil filter and oil cooler used:	1.6-1.8 L (1.7-1.9 U.S. qt.)		
Lubrication:	Full Pressure w/full Flow Filter		

Model:	CH730	CH26/CH735	CH740	CH745	CH750
Bore:	83 (3.27)	83 (3.27)	83 (3.27)	83 (3.27)	83 (3.27)
Stroke:	67 (2.64)	67 (2.64)	67 (2.64)	67 (2.64)	69 (2.72)
Displacement:	725 (44)	725 (44)	725 (44)	725 (44)	747 (45.6)
Power (@ 3600 RPM):	18.6 (25*)	19.4 (26*)	20.1 (27*)	20.9 (28*)	22.4 (30*)
Compression Ratio:	9:1	9:1	9:1	9:1	9.4:1
Weight:	43 (94)	43 (94)	43 (94)	43 (94)	47 (105)
Oil Capacity (w/filter) - approximate, determined by oil filter and oil cooler used:	1.6-1.8 L (1.7-1.9 U.S. qt.)				
Lubrication:	Full Pressure w/full Flow Filter				

Exhaust Emission Control System for models CH18/CH620, CH20/CH640, CH23/CH680, CH730, CH740, CH750 is EM.
Exhaust Emission Control System for models CH26/CH735 and CH745 are EM, O2S, ECM, MFI.

*Horsepower ratings exceed Society of Automotive Engineers Small Engine Test Code J1940. Actual engine horsepower is lower and affected by, but not limited to, accessories (air cleaner, exhaust, charging, cooling, fuel pump, etc.), application, engine speed and ambient operating conditions (temperature, humidity, and altitude). Kohler reserves the right to change product specifications, designs and equipment without notice and without incurring obligation.

5. On units with EFI engines, disconnect the negative (-) battery cable or use a battery minder trickle charger while the unit is in storage.
6. Store the engine in a clean, dry place.

Parts Ordering

The engine Specification, Model, and Serial Numbers are required when ordering replacement parts from your Kohler Engine Service Dealer. These numbers are found on the identification plate which is affixed to the engine shrouding. Include letter suffixes if there are any. See Engine Identification Numbers on page 6.

Always insist on genuine Kohler parts. All genuine Kohler parts meet strict standards for fit, reliability, and performance.

Major Repair

Major repair information is available in Kohler Engine Service Manuals. This type of repair generally requires the services of a trained mechanic and the use of special tools and equipment. Kohler Engine Service Dealers have the facilities, training, and genuine Kohler replacement parts necessary to perform this service.

For the nearest Sales & Service location:

- visit our website www.kohlerengines.com
- call 1-800-544-2444 (U.S. & Canada)
- look in the yellow pages under Engines-Gasoline

LIMITED 2 YEAR COMMAND ENGINE WARRANTY

Kohler Co. warrants to the original consumer that each new COMMAND engine sold by Kohler Co. will be free from manufacturing defects in materials or workmanship in normal service for a period of two (2) years from date of purchase, provided it is operated and maintained in accordance with Kohler Co.'s instructions and manuals.

Our obligation under this warranty is expressly limited, at our option, to the replacement or repair at Kohler Co., Kohler, Wisconsin 53044, or at a service facility designated by us of such parts as inspection shall disclose to have been defective.

EXCLUSIONS:

Mufflers on engines used commercially (non-residential) are warranted for one (1) year from date of purchase, except catalytic mufflers, which are warranted for two (2) years.

This warranty does not apply to defects caused by casualty or unreasonable use, including faulty repairs by others and failure to provide reasonable and necessary maintenance.

The following items are not covered by this warranty:

Engine accessories such as fuel tanks, clutches, transmissions, power-drive assemblies, and batteries, unless supplied or installed by Kohler Co. These are subject to the warranties, if any, of their manufacturers.

KOHLER CO. AND/OR THE SELLER SHALL NOT BE LIABLE FOR SPECIAL, INDIRECT, INCIDENTAL, OR CONSEQUENTIAL DAMAGES OF ANY KIND, including but not limited to labor costs or transportation charges in connection with the repair or replacement of defective parts.

IMPLIED OR STATUTORY WARRANTIES, INCLUDING WARRANTIES OF MERCHANTABILITY OR FITNESS FOR A PARTICULAR PURPOSE, ARE EXPRESSLY LIMITED TO THE DURATION OF THIS WRITTEN WARRANTY. We make no other express warranty, nor is any one authorized to make any on our behalf.

Some states do not allow limitations on how long an implied warranty lasts, or the exclusion or limitation of incidental or consequential damages, so the above limitation or exclusion may not apply to you.

This warranty gives you specific legal rights, and you may also have other rights which vary from state to state.

TO OBTAIN WARRANTY SERVICE:

Purchaser must bring the engine to an authorized Kohler service facility. To locate the nearest facility, visit our website, www.kohlerengines.com, and click on DEALER LOCATOR to use the locator function, consult your Yellow Pages or telephone 1-800-544-2444.

ENGINE DIVISION, KOHLER CO., KOHLER, WISCONSIN 53044

KOHLER CO. FEDERAL AND CALIFORNIA EMISSION CONTROL SYSTEMS LIMITED WARRANTY SMALL OFF-ROAD AND CLASS 1 LSI ENGINES

The U.S. Environmental Protection Agency (EPA), the California Air Resources Board (CARB), and Kohler Co. are pleased to explain the Federal and California Emission Control Systems Warranty on your off-road equipment engine. In California beginning in 2006, "emissions" means both exhaust and evaporative emissions. For California, small off-road engines produced in 2006 and later, and Class 1 LSI (Large Spark Ignited engines at or below 1.0 liter) produced in 2002 and later, must be designed, built and equipped to meet the state's stringent anti-smog standards. In other states, 1997 and later model year engines must be designed, built and equipped, to meet the U.S. EPA regulations for non-road engines. The engine must be free from defects in materials and workmanship, which cause it to fail to conform with U.S. EPA standards for the first two years of engine use from the date of sale to the ultimate purchaser. Kohler Co. must warrant the emission control system on the engine for the period of time listed above, provided there has been no abuse, neglect or improper maintenance.

The emission control system may include parts such as the carburetor or fuel injection system, the ignition system, and catalytic converter. Also included are the hoses, belts and connectors and other emission-related assemblies.

Where a warrantable condition exists, Kohler Co. will repair the engine at no cost, including diagnosis (if the diagnostic work is performed at an authorized dealer), parts and labor.

MANUFACTURER'S WARRANTY COVERAGE

Small off-road engines produced in 2006 or later, and Class 1 LSI engines produced in 2002 and later, are warranted for two years in California. In other states, 1997 and later model year engines are warranted for two years. If any emission related part on the engine is defective, the part will be repaired or replaced by Kohler Co. free of charge.

OWNER'S WARRANTY RESPONSIBILITIES

(a) The engine owner is responsible for the performance of the required maintenance listed in the owner's manual. Kohler Co. recommends that you retain all receipts covering maintenance on the engine, but Kohler Co. cannot deny warranty solely for the lack of receipts or for your failure to assure that all scheduled maintenance was performed.

(b) Be aware, however, that Kohler Co. may deny warranty coverage if the engine or a part has failed due to abuse, neglect, improper maintenance or unapproved modifications.

Continued on next page.

- (c) For warranty repairs, the engine must be presented to a Kohler Co. service center as soon as a problem exists. Call 1-800-544-2444 or access our website at: www.kohlerengines.com, for the names of the nearest service centers. The warranty repairs should be completed in a reasonable amount of time, not to exceed 30 days.

If you have any questions regarding warranty rights and responsibilities, you should contact Kohler Co. at 1-920-457-4441 and ask for an Engine Service representative.

COVERAGE

Kohler Co. warrants to the ultimate purchaser and each subsequent purchaser that the engine will be designed, built and equipped, at the time of sale, to meet all applicable regulations. Kohler Co. also warrants to the initial purchaser and each subsequent purchaser, that the engine is free from defects in materials and workmanship which cause the engine to fail to conform with applicable regulations for a period of two years.

Small off-road engines produced in 2006 or later, and Class 1 LSI engines produced in 2002 and later, are warranted for two years in California. For 1997 and later model years, EPA requires manufacturers to warrant engines for two years in all other states. These warranty periods will begin on the date the engine is purchased by the initial purchaser. If any emission related part on the engine is defective, Kohler Co. will replace the part at no cost to the owner. Kohler Co. is liable for damages to other engine components caused by the failure of a warranted part still under warranty.

Kohler Co. shall remedy warranty defects at any authorized Kohler Co. engine dealer or warranty station. Warranty repair work done at an authorized dealer or warranty station shall be free of charge to the owner if such work determines that a warranted part is defective.

Listed below are the parts covered by the Federal and California Emission Control Systems Warranty. Some parts listed below may require scheduled maintenance and are warranted up to the first scheduled replacement point for that part. The warranted parts include the following if they were present in the engine purchased:

- Oxygen sensor (if equipped)
- Intake manifold (if equipped)
- Exhaust manifold (if equipped)
- Catalytic muffler (if equipped)
- Thermal reactor muffler (if equipped)
- Fuel lines, fuel line fittings and clamps (if equipped)
- Spark advance module (if equipped)
- Crankcase breather
- Air Injection System (if equipped)
 - Air pump or pulse valve assembly (if equipped)
 - Control/distribution valve (if equipped)
 - Distribution manifold (if equipped)
 - Air hoses (if equipped)
 - Vacuum lines (if equipped)
- Ignition module(s) with high tension lead
- Gaseous fuel regulator (if equipped)
- Electronic control unit (if equipped)
- Carburetor or fuel injection system
- Fuel metering valve (if equipped)
- Air filter, fuel filter, and spark plugs (only to first scheduled replacement point)
- Evaporative System (if equipped)
 - Canister (if equipped)
 - Canister filter (if equipped)
 - Vapor hose (if equipped)
 - Orifice connector (if equipped)
 - Fuel tank (if equipped)
 - Fuel cap (if equipped)
 - Primer bulb canister (if equipped)

LIMITATIONS

This Emission Control Systems Warranty shall not cover any of the following:

- (a) repair or replacement required because of misuse or neglect, improper maintenance, repairs improperly performed or replacements not conforming to Kohler Co. specifications that adversely affect performance and/or durability and alterations or modifications not recommended or approved in writing by Kohler Co.,
- (b) replacement of parts and other services and adjustments necessary for required maintenance at and after the first scheduled replacement point,
- (c) consequential damages such as loss of time, inconvenience, loss of use of the engine or equipment, etc.,
- (d) diagnosis and inspection fees that do not result in eligible warranty service being performed, and
- (e) any add-on or modified part, or malfunction of authorized parts due to the use of add-on or modified parts.

MAINTENANCE AND REPAIR REQUIREMENTS

The owner is responsible for the proper use and maintenance of the engine. Kohler Co. recommends that all receipts and records covering the performance of regular maintenance be retained in case questions arise. If the engine is resold during the warranty period, the maintenance records should be transferred to each subsequent owner. Kohler Co. reserves the right to deny warranty coverage if the engine has not been properly maintained; however, Kohler Co. may not deny warranty repairs solely because of the lack of repair maintenance or failure to keep maintenance records.

Normal maintenance, replacement or repair of emission control devices and systems may be performed by any repair establishment or individual; however, **warranty repairs must be performed by a Kohler authorized service center.** Any replacement part or service that is equivalent in performance and durability may be used in non-warranty maintenance or repairs, and shall not reduce the warranty obligations of the engine manufacturer.

KOHLER[®] ENGINES

FOR SALES AND SERVICE INFORMATION
IN U.S. AND CANADA, CALL **1-800-544-2444**

KohlerEngines.com

ENGINE DIVISION, KOHLER CO., KOHLER, WISCONSIN 53044

FORM NO.: 24 590 01-B

ISSUED: 11/04

REVISED: 8/08

LITHO IN U.S.A.



1P24 590 01-B



6 50531 80673 4