

KOHLER 2000 Series

RH255, RH265 Owner's Manual

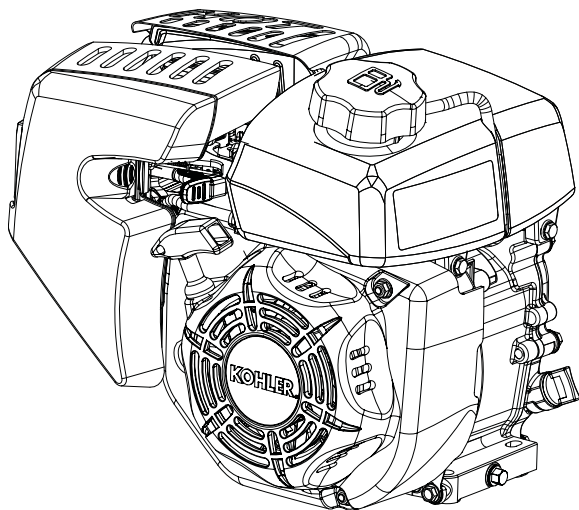

EN
DE
ESE
ESS
FRC
FRF
HR
ID
IT
PT
RO
RU
SL
TR
ZH

IMPORTANT: Read all safety precautions and instructions carefully before operating equipment. Refer to operating instruction of equipment that this engine powers.

Ensure engine is stopped and level before performing any maintenance or service.

Warranty coverage as outlined in the warranty card and on KohlerEngines.com. Please review carefully as it provides you specific rights and obligations.

To maintain compliance with applicable emission regulations, exhaust system backpressure may not exceed limits which can be found on KohlerEngines.com. Search by Model No., select Read More, then select Specs tab.

Record engine information to reference when ordering parts or obtaining warranty coverage.

Engine Model _____

Specification _____

Serial Number _____

Purchase Date _____

Safety Precautions

⚠ WARNING: A hazard that could result in death, serious injury, or substantial property damage.

⚠ CAUTION: A hazard that could result in minor personal injury or property damage.

NOTE: is used to notify people of important installation, operation, or maintenance information.

	<p>⚠ WARNING</p> <p>Explosive Fuel can cause fires and severe burns.</p> <p>Do not fill fuel tank while engine is hot or running.</p>
<p>Gasoline is extremely flammable and its vapors can explode if ignited. Store gasoline only in approved containers, in well ventilated, unoccupied buildings, away from sparks or flames. Spilled fuel could ignite if it comes in contact with hot parts or sparks from ignition. Never use gasoline as a cleaning agent.</p>	

	<p>⚠ WARNING</p> <p>Carbon Monoxide can cause severe nausea, fainting or death.</p> <p>Avoid inhaling exhaust fumes.</p>
<p>Engine exhaust gases contain poisonous carbon monoxide. Carbon monoxide is odorless, colorless, and can cause death if inhaled.</p>	

	<p>⚠ WARNING</p> <p>Accidental Starts can cause severe injury or death.</p> <p>Disconnect and ground spark plug lead(s) before servicing.</p>
<p>Before working on engine or equipment, disable engine as follows: 1) Disconnect spark plug lead(s). 2) Disconnect negative (-) battery cable from battery.</p>	

	<p>⚠ WARNING</p> <p>Rotating Parts can cause severe injury.</p> <p>Stay away while engine is in operation.</p>
<p>Keep hands, feet, hair, and clothing away from all moving parts to prevent injury. Never operate engine with covers, shrouds, or guards removed.</p>	

	<p>⚠ CAUTION</p> <p>Electrical Shock can cause injury.</p> <p>Do not touch wires while engine is running.</p>
---	--

	<p>⚠ WARNING</p> <p>Hot Parts can cause severe burns.</p> <p>Do not touch engine while operating or just after stopping.</p>
<p>Never operate engine with heat shields or guards removed.</p>	

California Proposition 65 Warning

Engine exhaust from this product contains chemicals known to State of California to cause cancer, birth defects, or other reproductive harm.

California Proposition 65 Warning

This product contains chemicals known to State of California to cause cancer, birth defects, or other reproductive harm.

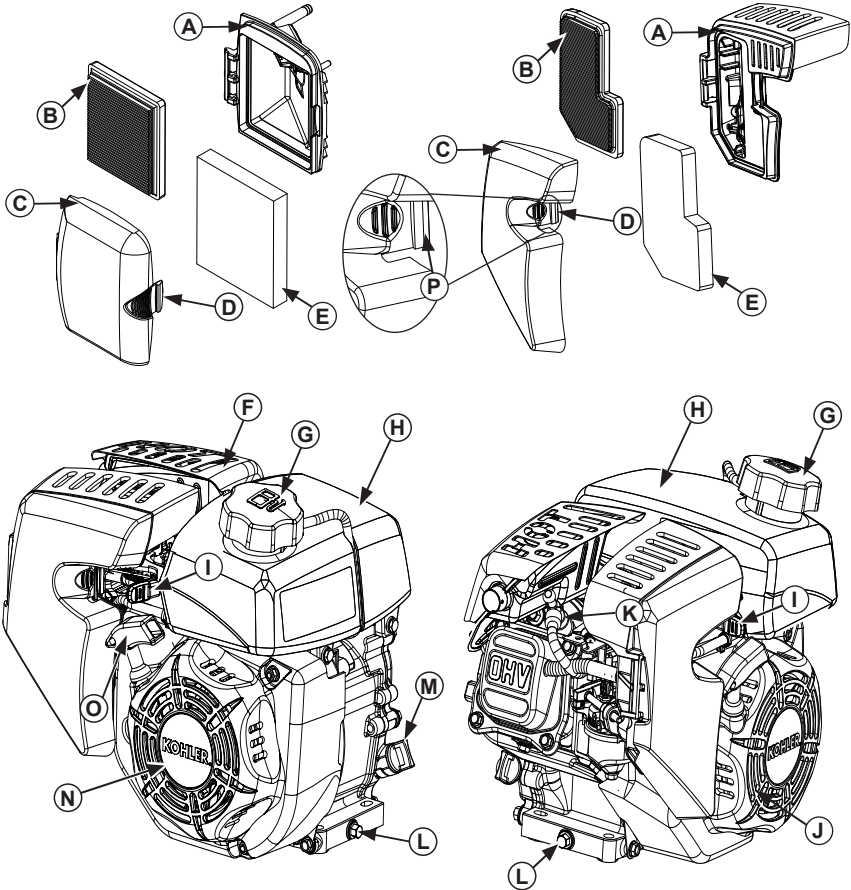

A	Air Cleaner Base	B	Paper Element	C	Air Cleaner Cover	D	Cover Latch
E	Foam Element	F	Muffler Shield	G	Fuel Cap	H	Fuel Tank
I	Lever	J	Debris Screen	K	Spark Plug	L	Oil Drain Plug
M	Dipstick/Oil Fill Plug	N	Retractable Starter	O	Starter Handle	P	Press Here

Pre-Start Checklist

1. Check oil level. Add oil if low. Do not overfill.
2. Check fuel level. Add fuel if low. Check fuel system components and lines for leaks.
3. Check and clean cooling areas, air intake areas and external surfaces of engine (particularly after storage).
4. Check that air cleaner components and all shrouds, equipment covers, and guards are in place and securely fastened.
5. Check spark arrestor (if equipped).

Starting



WARNING

Carbon Monoxide can cause severe nausea, fainting or death. Avoid inhaling exhaust fumes.

Engine exhaust gases contain poisonous carbon monoxide. Carbon monoxide is odorless, colorless, and can cause death if inhaled.



WARNING

Rotating Parts can cause severe injury. Stay away while engine is in operation.

Keep hands, feet, hair, and clothing away from all moving parts to prevent injury. Never operate engine with covers, shrouds, or guards removed.

NOTE: Choke position for starting may vary depending upon temperature and other factors. Once engine is running and warm, turn choke to OFF position.

NOTE: Extend starter cord periodically to check its condition. If cord is frayed have it replaced immediately by a Kohler authorized dealer.

NOTE: Do not crank engine continuously for more than 10 seconds. Allow a 60 second cool down period between starting attempts. Failure to follow these guidelines can burn out starter motor.

NOTE: If engine develops sufficient speed to disengage starter but does not keep running (a false start), engine rotation must be allowed to come to a complete stop before attempting to restart engine. If starter is engaged while flywheel is rotating, starter pinion and flywheel ring gear may clash, resulting in damage to starter.

1. Turn fuel shut-off valve to ON position (if equipped).
2. Start engine as follows:
Cold engine: Place lever in choke position.
Warm engine: Place lever in full throttle/FAST position.

3. Retractable Start: Slowly pull starter handle until just past compression-STOP! Return starter handle; firmly pull straight out to avoid excessive rope wear from starter rope guide.

Electric Start: Activate starter switch. Release switch as soon as engine starts. If starter does not turn engine over, shut off starter immediately. Do not make further attempts to start engine until condition is corrected. Do not jump start. See your Kohler authorized dealer for trouble analysis.

4. Gradually move lever to FAST position after engine starts and warms up. Engine/ equipment may be operated during warm up period, but it may be necessary to leave choke partially on until engine warms up.

Cold Weather Starting Hints

1. Use proper oil for temperature expected.
2. Disengage all possible external loads.
3. Use fresh winter grade fuel. Winter grade fuel has higher volatility to improve starting.

Stopping

1. If possible, remove load by disengaging all PTO driven attachments.
2. Move lever to stop position.
3. If equipped, close fuel shut-off valve.

Angle of Operation

Refer to operating instructions of equipment this engine powers. Do not operate this engine exceeding maximum angle of operation; see specification table. Engine damage could result from insufficient lubrication.

Engine Speed

NOTE: Do not tamper with governor setting to increase maximum engine speed. Overspeed is hazardous and will void warranty.



High Altitude Operation

If this engine is operated at an altitude of 4000 ft. (1219 meters) or above, a high altitude carburetor kit is required. To obtain high altitude carburetor kit information or to find a Kohler authorized dealer, visit KohlerEngines.com or call 1-800-544-2444 (U.S. and Canada).

This engine should be operated in its original configuration below 4000 ft. (1219 meters).

Operating this engine with the wrong engine configuration at a given altitude may increase its emissions, decrease fuel efficiency and performance, and result in damage to the engine.

Maintenance Instructions

	 WARNING	<p>Before working on engine or equipment, disable engine as follows: 1) Disconnect spark plug lead(s). 2) Disconnect negative (-) battery cable from battery.</p>
	<p>Accidental Starts can cause severe injury or death.</p> <p>Disconnect and ground spark plug lead(s) before servicing.</p>	

Normal maintenance, replacement or repair of emission control devices and systems may be performed by any repair establishment or individual; however, warranty repairs must be performed by a Kohler authorized dealer found at KohlerEngines.com or 1-800-544-2444 (U.S. and Canada).

Maintenance Schedule

After first 5 Hours

- Change oil.

Every 100 Hours or Annually¹

- Clean/replace foam element.
- Replace paper element.
- Change oil.
- Clean cooling areas.
- Clean spark arrestor (if equipped).
- Replace fuel filter (if equipped).

¹ Perform these procedures more frequently under severe, dusty, dirty conditions.

Oil Recommendations

We recommend use of Kohler oils for best performance. Other high-quality detergent oils (including synthetic) of API (American Petroleum Institute) service class SJ or higher are acceptable. Select viscosity based on air temperature at time of operation as shown in table below.

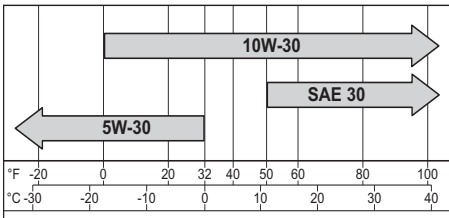

Check Oil Level

NOTE: To prevent extensive engine wear or damage, never run engine with oil level below or above operating range indicator on dipstick.

Ensure engine is cool. Clean oil fill/dipstick areas of any debris.

1. Remove dipstick; wipe oil off.
2. Reinsert dipstick into tube; rest on oil fill neck; turn counterclockwise until cap drops to lowest point of thread leads; do not thread cap onto tube.
 - a. Remove dipstick; check oil level. Level should be at top of indicator on dipstick.
 - or
 - b. Remove oil fill plug. Level should be up to point of overflowing filler neck.
3. If oil is low, add oil up to point of overflowing filler neck.
4. Reinstall dipstick or oil fill plug and tighten securely.

Change Oil

Change oil while engine is warm.

1. Clean area around oil fill cap/dipstick and drain plug.
2. Remove drain plug and oil fill cap/dipstick. Drain oil completely.
3. Reinstall drain plug. Torque to 13 ft. lb. (17.6 N·m).
4. Fill crankcase with new oil, up to point of overflowing filler neck.
5. Reinstall oil fill cap/dipstick and tighten securely.
6. Dispose of used oil in accordance with local ordinances.

Oil Sentry™ (if equipped)

This switch is designed to prevent engine from starting in a low oil or no oil condition. Oil Sentry™ may not shut down a running engine before damage occurs. In some applications this switch may activate a warning signal. Read your equipment manuals for more information.

Fuel Recommendations

	<p>! WARNING</p> <p>Explosive Fuel can cause fires and severe burns.</p> <p>Do not fill fuel tank while engine is hot or running.</p>
<p>Gasoline is extremely flammable and its vapors can explode if ignited. Store gasoline only in approved containers, in well ventilated, unoccupied buildings, away from sparks or flames. Spilled fuel could ignite if it comes in contact with hot parts or sparks from ignition. Never use gasoline as a cleaning agent.</p>	

NOTE: E15, E20 and E85 are NOT approved and should NOT be used; effects of old, stale or contaminated fuel are not warrantable.

Fuel must meet these requirements:

- Clean, fresh, unleaded gasoline.
- Octane rating of 87 (R+M)/2 or higher.
- Research Octane Number (RON) 90 octane minimum.
- Gasoline up to 10% ethyl alcohol, 90% unleaded is acceptable.
- Methyl Tertiary Butyl Ether (MTBE) and unleaded gasoline blend (max 15% MTBE by volume) are approved.
- Do not add oil to gasoline.
- Do not overfill fuel tank.
- Do not use gasoline older than 30 days.

Add Fuel

	<p>! WARNING</p> <p>Explosive Fuel can cause fires and severe burns.</p> <p>Do not fill fuel tank while engine is hot or running.</p>
<p>Gasoline is extremely flammable and its vapors can explode if ignited. Store gasoline only in approved containers, in well ventilated, unoccupied buildings, away from sparks or flames. Spilled fuel could ignite if it comes in contact with hot parts or sparks from ignition. Never use gasoline as a cleaning agent.</p>	



Ensure engine is cool.

1. Clean area around fuel cap.
2. Remove fuel cap. Fill to base of filler neck. Do not overfill fuel tank. Leave room for fuel to expand.
3. Reinstall fuel cap and tighten securely.

Fuel Line

Low permeation fuel line must be installed on carbureted Kohler Co. engines to maintain EPA and CARB regulatory compliance.

Spark Plugs

	 CAUTION
	Electrical Shock can cause injury. Do not touch wires while engine is running.

Clean out spark plug recess. Remove plug and replace.

1. Check gap using wire feeler gauge. Adjust gap, see specification table for adjustment.
2. Install plug into cylinder head.
3. Torque plug to 20 ft. lb. (27 N·m).

Air Cleaner

NOTE: Operating engine with loose or damaged air cleaner components could cause premature wear and failure. Replace all bent or damaged components.

NOTE: Paper element cannot be blown out with compressed air.

Unhook cover latch and remove air cleaner cover.

Paper Element: Remove and replace paper element.



Foam Element: Remove foam element; replace or wash in warm water with detergent. Rinse and allow to air dry.

Reinstall air cleaner cover and secure cover latch.

Breather Tube

Ensure both ends of breather tube are properly connected.

Air Cooling

	 WARNING
	Hot Parts can cause severe burns. Do not touch engine while operating or just after stopping.
Never operate engine with heat shields or guards removed.	

Proper cooling is essential. To prevent over heating, clean screens, cooling fins, and other external surfaces of engine. Avoid spraying water at wiring harness or any electrical components. See Maintenance Schedule.

Repairs/Service Parts

We recommend that you use a Kohler authorized dealer for all maintenance, service, and replacement parts for engine. To find a Kohler authorized dealer visit KohlerEngines.com or call 1-800-544-2444 (U.S. and Canada).

Storage

If engine will be out of service for 2 months or more follow procedure below.

1. Add Kohler PRO Series fuel treatment or equivalent to fuel tank. Run engine 2-3 minutes to get stabilized fuel into fuel system (failures due to untreated fuel are not warrantable).
2. Change oil while engine is still warm from operation. Remove spark plug(s) and pour about 1 oz. of engine oil into cylinder(s). Replace spark plug(s) and crank engine slowly to distribute oil.
3. Disconnect negative (-) battery cable.
4. Store engine in a clean, dry place.

Troubleshooting

Do not attempt to service or replace major engine components, or any items that require special timing or adjustment procedures. This work should be performed by a Kohler authorized dealer.

Problem	Possible Cause							
	No Fuel	Improper Fuel	Dirt In Fuel Line	Dirty Debris Screen	Incorrect Oil Level	Engine Overloaded	Dirty Air Cleaner	Faulty Spark Plug
Will Not Start	•	•	•		•	•	•	•
Hard Starting		•	•		•	•	•	•
Stops Suddenly	•		•	•	•	•	•	•
Lacks Power		•	•	•	•	•	•	•
Operates Erratically		•	•	•		•	•	•
Knocks or Pings		•		•		•		•
Skips or Misfires		•	•	•			•	•
Backfires		•	•			•	•	•
Overheats		•	•	•	•	•	•	
High Fuel Consumption						•	•	•

Engine Specifications

Model	Bore	Stroke	Displacement	Oil Capacity (Refill)	Spark Plug Gap	Maximum Angle of Operation (@ full oil level)*
RH255	2.7 in.	2.1 in.	12 cu. in.	0.63 qt.	0.03 in.	25°
RH265	(68 mm)	(54 mm)	(196 cc)	(0.60 L)	(0.76 mm)	

*Exceeding maximum angle of operation may cause engine damage from insufficient lubrication.

Additional specification information can be found in service manual at KohlerEngines.com.

Exhaust Emission Control System for models RH255, RH265 is EM for U.S. EPA, California, and Europe.

Any and all horsepower (hp) references by Kohler are Certified Power Ratings and per SAE J1940 & J1995 hp standards. Details on Certified Power Ratings can be found at KohlerEngines.com.