



36" straight grab bar
8001036

Features

- Adjustable mounting brackets to fit specific installation requirements.
- Elliptical shape makes the bar easier to grip.
- Available in finishes to coordinate with nickel and silver shower door finishes.

Material

- Anodized aluminum construction with a durable rust-proof and chip-resistant finish.

Installation

- Installs from front side of wall.

Recommended Products/Accessories

K-23723 Faucet cleaner

Included Components

Additional Components:
Installation hardware



Codes/Standards

ASTM F446

STERLING® Warranty - Grab Bars

See website for detailed warranty information.

Available Colors/Finishes

Color tiles intended for reference only.

Color	Code	Description
	N	Nickel
	V	Matte Silver

1-800-STERLING (1-800-783-7546)

Kohler Co. reserves the right to make revisions without notice to product specifications.

For the most current Specification Sheet, go to www.sterlingplumbing.com.

12-29-2021 11:11 - US/CA

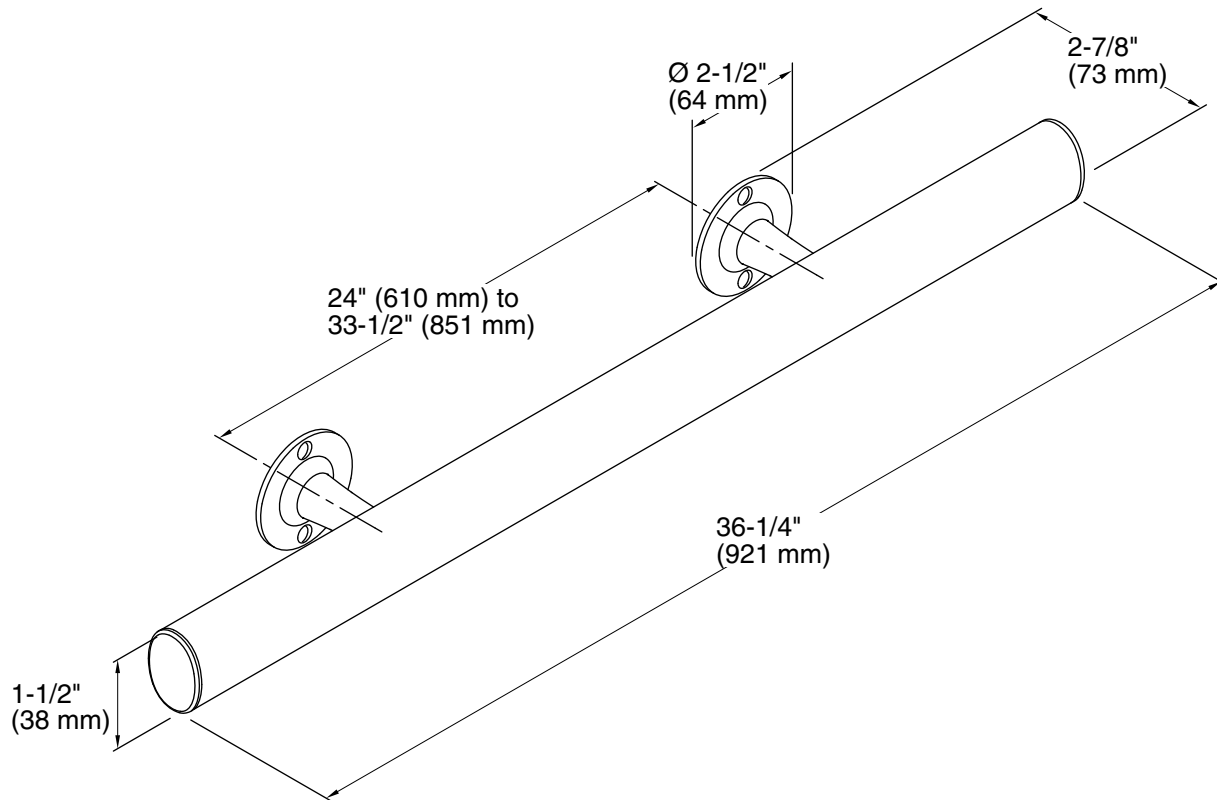

Technical Information

All product dimensions are nominal.

Material: Anodized Aluminum

Notes

Install this product according to the installation guide.

WARNING: Risk of personal injury. Unless properly installed, the grab bar may not adequately support the weight of the user.

Custom Walls – Fasten grab bar directly to studs when possible. If not possible, install a 1" x 6" blocking board to studs prior to installing wallboard and finished wall material.

Sterling Age-in-Place Surrounds – Obtain backer board locations from the specification sheet for your model to select the appropriate grab bar size.