



Finesse™ Peak®

Headerless frameless pivot shower door

5698-42

Features

- Heavy 1/4" (6 mm) glass for strength and stability.
- CleanCoat®+ glass coating creates a hydrophobic barrier that repels water, soap scum, and residue, saving time and protecting shower doors 10 times longer than original CleanCoat. (Based on 2021 internal wear/abrasion testing using a microfiber cloth.)

Technology

- Tempered glass ensures maximum safety and durability.

Installation

- Out-of-plumb adjustability simplifies installation.
- Door can be installed to open to the left or right to suit your bathroom layout.
- Not for use in hospitality.
- For residential use only.

Recommended Products/Accessories

K-23723 Faucet cleaner

Included Components

Additional Components:
Hardware kit



Codes/Standards







ANSI Z97.1
CPSC 16CFR 1201

STERLING® Warranty - Bath and Shower Doors

See website for detailed warranty information.

Available Colors/Finishes

Color tiles intended for reference only.

Color	Code	Description
	ADR	Anodized Deep Bronze
	ADR	Anodized Deep Bronze
	N	Nickel
	N	Nickel
	S	Silver
	S	Silver

Available Glass Options

Code	Description
G05	Clear
G03	Frosted

1-800-STERLING (1-800-783-7546)

Kohler Co. reserves the right to make revisions without notice to product specifications.

For the most current Specification Sheet, go to www.sterlingplumbing.com.

9-24-2021 05:02 - US//CA

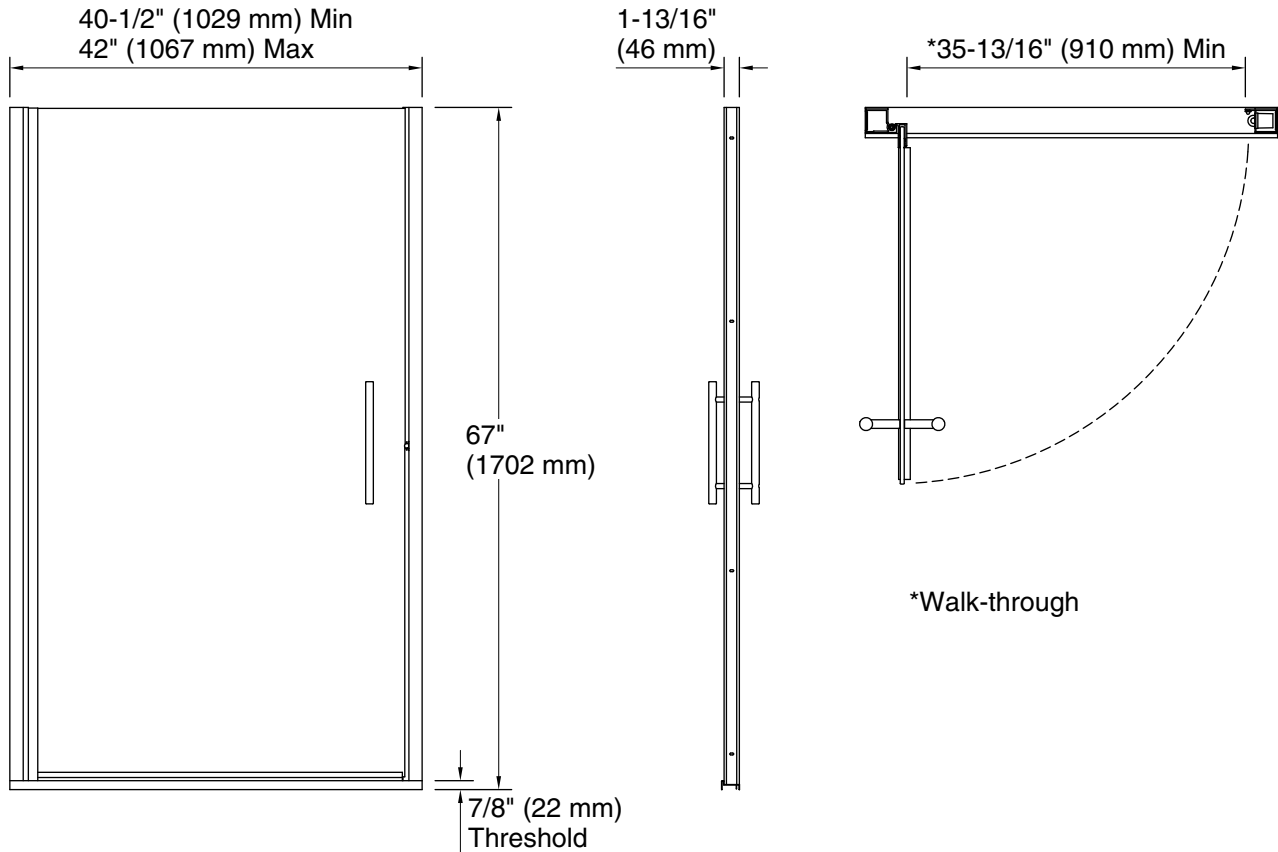

Technical Information

All product dimensions are nominal.

- Installation type: For shower base installation
- Opening Width - Min: 40-1/2" (1029 mm)
- Opening Width - Max: 42" (1067 mm)
- Walk-through - Min: 35-13/16" (909 mm)
- Base-To-Wall Radius - Max: 1/2" (13 mm)
- Glass thickness: 1/4" (6 mm)
- Glass coating: CleanCoat®

Notes

- Install this product according to the installation instructions.
- The vertical opening should be a minimum of 67" (1702 mm) to allow for installation clearance.