

Mira Sport Thermostatic

9.0 and 9.8 kW

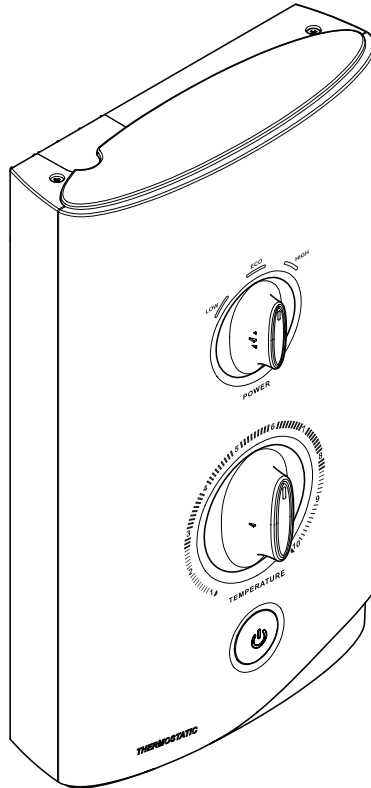

For SPARES,
ADVICE or REPAIRS
please call us free
on 0800 001 4040
(UK only)

Installation and User Guide

These instructions must be left with the user

Showering perfection

mira
SHOWERS

Important Safety Information

WARNING - This shower can deliver scalding temperatures, cause fire, electric shock or other personal injury if not operated, or maintained in accordance with the instructions, warnings and cautions contained in this guide and on the appliance.

Please read the important safety information and the operation section of this guide before using the shower. Failure to follow the instructions provided with this shower will invalidate the guarantee.

TO REDUCE THE RISK OF FIRE, ELECTRIC SHOCK OR INJURY:

1. Children younger than 3 years should not use this shower. Children 3 years to under 8 years should only use this shower under continuous supervision. Children aged 8 years and above and persons with reduced physical, sensory or mental capabilities or lack of experience or knowledge can use the shower if they are given supervision or instruction concerning use of the appliance in a safe way and understand the hazards involved.
2. Children shall not be allowed to play with the shower.
3. **DO NOT** restrict the water flow from the shower outlet, temporarily bending the shower hose or blocking the shower head while in use can cause a hot shot of water to be discharged.
4. Cleaning and user maintenance shall not be made by children without supervision.
5. The outlet must not be connected to any tap or fitting other than those specified.
6. The showerhead must be descaled regularly. Any blockage of the showerhead or hose can cause damage to the shower.
7. **Warning! DO NOT** switch on if there is a possibility that the water in the heater is frozen.
8. The shower must be provided with means for local disconnection from the supply mains having a contact separation in all poles that provide full disconnection under overvoltage category III, the instructions state that means for disconnection must be incorporated in the fixed wiring in accordance with the wiring rules.

9. Installation of the shower must be carried out in accordance with these instructions by qualified, competent personnel. Read all instructions before installing the shower.
10. **DO NOT** switch the shower on if water starts leaking from the shower case. Isolate the electrical supply to the shower immediately.
11. **DO NOT** switch the shower on if the case appears to be damaged or incorrectly fitted. Isolate the electrical supply to the shower immediately.
12. **DO NOT** increase the power setting or adjust the temperature control rapidly while using the shower.
13. **DO NOT** switch the shower off and back on while standing in the water flow.
14. **DO NOT** change the handset model. Fit only shower heads recommended by Mira and do not fit any additional device to restrict the water outlet flow.
15. When adjusting the handset mode, point handset away from body and make sure that the water temperature has stabilised before continuing to shower.
16. Use caution when altering the water temperature, always check the temperature before continuing to shower.
17. Switch the shower off at the electrical isolating switch when not in use. This is recommended with all electrical appliances.
18. Installation of the shower must be carried out in accordance with these instructions by qualified, competent personnel. Read all instructions before installing the shower.
19. Isolate the electrical and water supplies before commencing installation. The electricity must be isolated at the consumer unit and the appropriate circuit fuse removed, if applicable. Mains connections are exposed when the cover is removed.
20. **DO NOT** install the shower in areas with high humidity and temperature (i.e. Steam rooms and saunas).
21. **DO NOT** install the shower where it may be exposed to freezing conditions. Ensure that any pipework that could become frozen is properly insulated.

22. **DO NOT** connect the outlet of the shower to any tap, control valve, trigger operated handset or showerhead other than those specified for use with this shower as the outlet acts as a vent for the tank body. Only Kohler Mira recommended accessories should be used.
23. **DO NOT** perform any unspecified modifications, or drill or cut holes in the product other than instructed by this guide. When servicing only use genuine Kohler Mira replacement parts.
24. **DO NOT** connect this shower to a Waste Water Heat Recovery System as this may cause unstable or scalding temperatures to be delivered from the shower head.
25. Always check the water temperature is safe before entering the shower.
26. The water supplies to this product must be isolated if the product is not to be used for a long period of time. If the product or pipework is at risk of freezing during this period they should also be drained of water.
27. If the shower is dismantled during installation or servicing then, upon completion, an inspection must be made to ensure all electrical connections are tight and that there are no leaks.
28. This appliance is intended to be permanently connected to the water mains and not connected by a hose set.
29. The water inlet of this appliance shall not be connected to a water supply obtained from any other water heating system.
30. **Warning!** This appliance is not to be used to provide a potable water supply.
31. Maximum Static Pressure is 1000 kPa (10 bar).
32. Minimum Dynamic Pressure is 70 kPa (0.7 bar) 9.0 kW and 9.8 kW.

Pack Contents

Tick the appropriate boxes to familiarize yourself with the part names and to confirm that the parts are included.

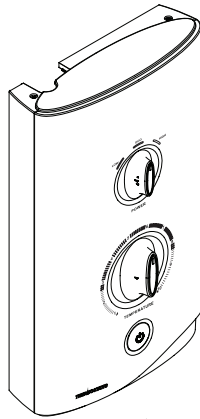

1 x Mira Sport Thermostatic Electric Shower

 1 x Olive

 1 x Compression Nut

 3 x Fixing Screws

 3 x Wall Plugs



2 x Case Inserts

Documentation

1 x Installation Template

1 x Installation & User Guide

1 x Guarantee Brochure

Wiring Diagram

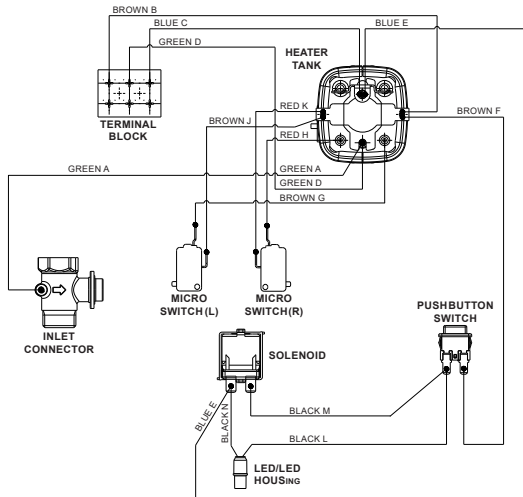

Internal Wiring Diagram

Introduction

Thank you for purchasing a quality Mira Sport Thermostatic Electric Shower. To enjoy the full potential of your new shower, please take time to read this guide thoroughly, and keep it handy for future reference.

Products manufactured by Kohler Mira Ltd are designed to be safe provided, that they are installed used and maintained in good working order, in accordance with our instructions and recommendations.

Follow all warnings, cautions and instructions contained in this guide, and on or inside the shower.

Mira Sport Thermostatic electric showers have separate controls for power selection and for temperature/flow adjustment. A unique flow regulator stabilises any temperature changes caused by water pressure fluctuations, which can result from taps being turned on or off or toilets being flushed.

Products Covered

Product Variant		Model No.	Colour
Mira Sport Thermostatic	9.0 kW	J03I	White/Chrome
Mira Sport Thermostatic	9.8 kW	J03J	White/Chrome

Recommended Usage

Domestic	✓	Light Commercial	✗
Heavy Commercial	✗	Healthcare	✗

Patents and Design Registration

Design Registration:	000373543-0003
Patents:	GB: 2 341 667, 2 404 000, 2 427 460, 2 428 286 Ireland: 82835, 85128, 85163, 85912

Specifications

Plumbing	Thermostatic Variant	
	Sport 9.0	Sport 9.8
Minimum Dynamic Pressure	70 kPa (0.7 bar)	
Maximum Dynamic Pressure *	500 kPa (5 bar)	
Minimum Static Pressure	20 kPa (0.2 bar)	
Maximum Static Pressure *	1000 kPa (10 bar)	
Maximum Inlet Temperature	30°C	
Minimum Inlet Temperature	2°C	
Inlet Connection	1/2" BSP Male / 15 mm Compression Fitting	
Maximum Water Hardness	200 ppm CaCO ₃	
Outlet Connection	1/2" BSP Male	

Electrical	Thermostatic Variant	
	Sport 9.0	Sport 9.8
Nominal Power at 230 V ac	8.3 kW	9.0 kW
Nominal Power at 240 V ac	9.0 kW	9.8 kW
Recommended MCB Rating	40 A	45 A
Maximum Supply Cable Size	16 mm ²	
Recommended RCD Rating	30 mA tripping current	
Recommended Isolator Switch	45 A double-pole with 3 mm contact separation	
Appliance Sealing Rating	IP X4 - Suitable for installation in Zone 1	
Maximum Ambient Temperature	30°C	
Minimum Ambient Temperature	2°C	

Dimensions	
Height	358 mm
Width	215 mm
Depth	90 mm

*A drop tight pressure reducing valve should be installed where dynamic or static pressure exceeds the figure stated in the Specifications.

Guarantee

The Mira Sport Thermostatic has been designed for domestic use only, Mira Showers guarantee the Mira Sport Thermostatic against any defect in materials or workmanship for a period of two years from the date of purchase (shower fittings for one year).

For non-domestic installations, Mira Showers guarantee the Mira Sport Thermostatic against any defect in materials or workmanship for a period of one year from the date of purchase.

For terms and conditions, refer to the back cover of this guide.

European Conformity Information

The Mira Sport Thermostatic range of showers complies with the following European directives:

2014/35/EU - Low Voltage Directive (LVD),

2014/30/EU - Electromagnetic Compatibility Directive (EMC),

2011/65/EU - Restriction of Hazardous Substances Directive (RoHS)

The Mira Sport range of showers are high power appliances and are subject to conditional connection. If the main electrical supply fuse is rated less than 80 Amps, the local electricity supply company must be contacted to confirm if the electrical supply is adequate.

The Mira Sport Thermostatic range of showers complies with the requirements of the UK's water regulations.

Disposal and Recycling

End of Product Life

Electrical and electronic devices contain a range of materials that can be separated for recycling and used in new products.



This product should not be disposed of with your general household waste. When this product has reached the end of its serviceable life, please remove any batteries and take it to a recognised WEEE (Waste Electrical and Electronic Equipment) collection facility such as your local civic amenity site for recycling.

Your local authority or retailer will be able to advise you of your nearest recycling facility.

Installation Requirements

Plumbing

1. The plumbing installation must comply with all national or local water regulations and all relevant building regulations, or any particular regulation or practice specified by the local water supply company.
2. **DO NOT** use sealing compounds on any pipe fitting or joints.
3. **DO NOT** install the product in a position in which service access is limited.
4. Decide on a suitable position for the shower (minimum distance of 200 mm from the ceiling to allow for cover fit and removal).
5. The position of the shower and shower fittings must provide a minimum gap of 25 mm between the showerhead and the spill over level of any bath, shower tray or basin and a minimum gap of 30 mm between the showerhead and the spill over level of any toilet, bidet or other appliance with a Fluid Category 5 backflow risk (see diagram on page 11).
6. The shower is suitable for installation within the shower area and is fitted with a pressure relief valve. It must be positioned over a water catchment area with the controls at a convenient height for the user.
7. **The shower must be fitted to a waterproof flat and even wall surface.**
8. **DO NOT** fit the shower to the wall and tile up to the case.
9. **DO NOT** seal the gap between the shower and the wall surface.
10. The showerhead should be positioned so that it discharges down the centre line of the bath or across the opening of a shower cubicle.
11. The showerhead must be directed away from the shower unit, during normal use the showerhead must not spray directly on to the shower unit.
12. **DO NOT** apply excessive force to plumbing connections; always provide mechanical support when making plumbing connections. Any soldered joints should be made before connecting the shower.
13. This shower is not designed to be plumbed directly from the rear. For rear-entry supply, add an elbow to the supply pipe and connect as a rising or a falling supply.
14. If pipework and/or electrical cables enter the shower from the rear through a hole in the wall provision must be made to prevent water ingress back into the wall structure.
15. Only use the inlet connector supplied with the shower. **DO NOT** use any other type of fitting.
16. A full bore/non restrictive servicing valve must be fitted in a readily accessible position adjacent to the shower to facilitate maintenance of the shower.
DO NOT use a valve with a loose washer plate (jumper) as this can lead to a build up of static pressure.

17. A water treatment device should be installed where the water hardness may exceed 200 ppm. Malfunctions caused by excessive limescale formation are not covered by this shower's guarantee (see back page for details).
18. The installation must not cause the hose to be sharply kinked during normal use.
19. **DO NOT** perform the electrical installation until the plumbing has been completed and checked for leaks.

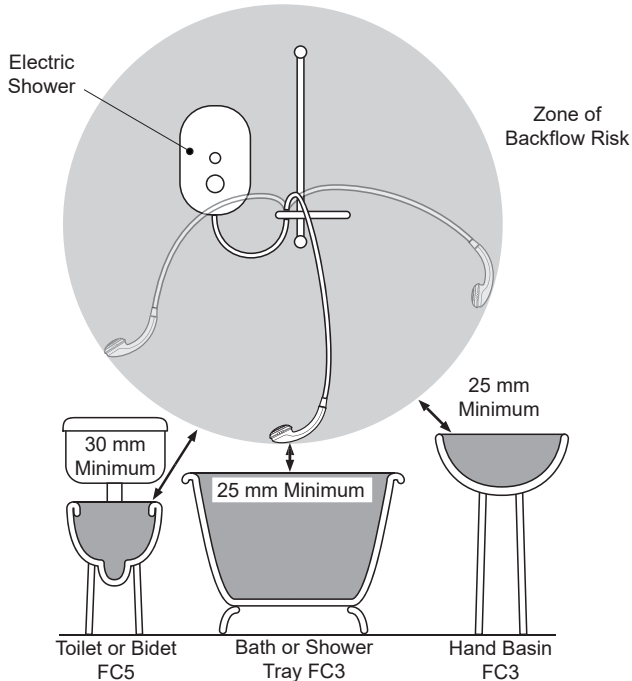

Hose retaining ring fitted and shower fittings fixed at a suitable height preventing dirty water backflow

Note: There will be occasions when the hose retaining ring will not provide a suitable solution for Fluid Category 3 installations, in these instances an outlet double check valve must be fitted, this will increase the required supply pressure typically by 10kPa (0.1 bar). Double check valves fitted in the inlet supply to the appliance cause a pressure build up, which affect the maximum static inlet pressure for the appliance and must not be fitted. For Fluid category 5 double check valves are not suitable.

Electrical

1. The electrical installation must comply with BS 7671 (commonly referred to as the IEE Wiring Regulations) and all relevant building regulations, or any particular regulation or practice specified by the local electricity supply company.
2. Ensure that all circuit protection devices, switches and cabling is adequate for the rated current of the shower and that the rating of the electricity supply company fuse and the consumer unit are adequate for the additional demand.
3. The shower **must** be earthed. Ensure any supplementary bonding complies with the relevant regulations.
4. This shower is intended to be permanently connected to the fixed electrical wiring of the mains system. A separate supply **must** be provided from the consumer unit to the shower.
5. **DO NOT** supply any other electrical equipment including extractor fans or pumps via this product.
6. This shower must be provided with means for local disconnection that is incorporated into the fixed wiring in accordance with the relevant local wiring regulations. This **must** be a double pole switch, which has at least 3 mm contact separation in each pole. The switch can be a ceiling mounted pull-cord type within the shower room or a wall mounted switch fitted in the applicable zone area.
7. A 30mA Residual Current Device (RCD) must be incorporated into the electrical supply to this shower in accordance with wiring regulations.
8. **DO NOT** apply excessive force to the terminal block.
9. All electrical connections should be checked for tightness to prevent overheating before switching on the electrical supply.
10. **DO NOT** switch on the electrical supply until the plumbing has been completed and checked for leaks.

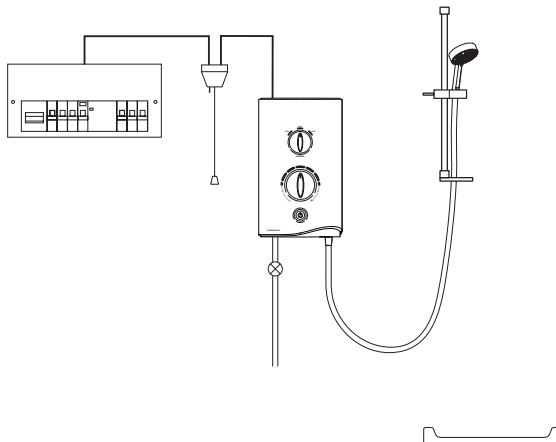

Plumbing and Electrical Schematic

Installation

Warning! Turn off the electrical and water supplies before proceeding with the installation of the shower.

1 Remove the three screws that hold the cover on and remove the cover.

2 Remove the service tunnel.

3 Using the installation template supplied, mark the positions of the **three** fixing holes.

Note: Ensure that there are sufficient lengths of supply pipe and electrical cable to reach the connection points.

4 Remove the installation template and drill three holes to suit the fixing screws and wall plugs.

Caution! Do not drill into cables or pipes in the wall.

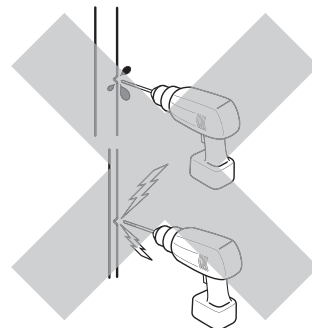
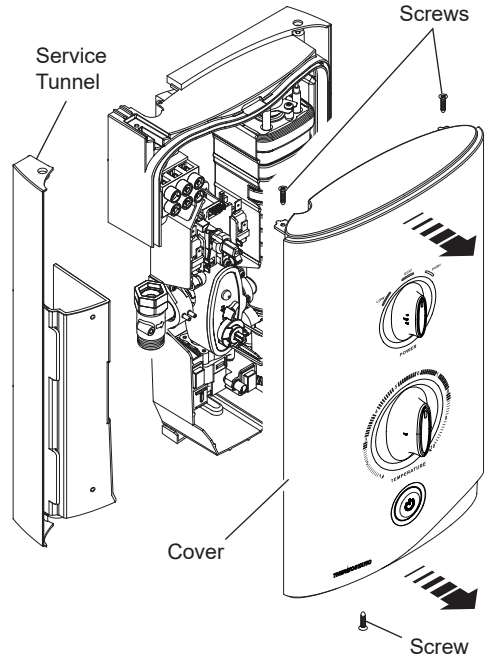

Caution! Do not drill into buried cables or pipes.

- 5 Determine the direction and route of the incoming water supply: falling (entering the shower from the top), or rising (entering the shower from the bottom).

Note: **DO NOT** use an incoming supply entering the shower directly from the back. Add an elbow to the supply pipe and connect it as a rising or falling supply.

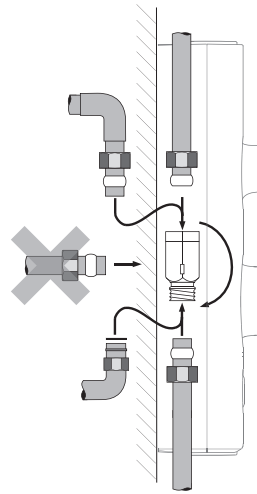

- 6 Thoroughly flush the supply pipe.

- 7 Rotate the inlet connector to suit the direction of the incoming water supply.

Inlet Connector

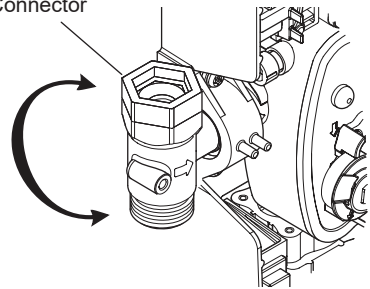

- 8 Upper and lower case inserts are supplied and should be fitted.

Note: Trim the inserts if necessary to fit incoming electrical or water supplies before fitting.

Case Insert

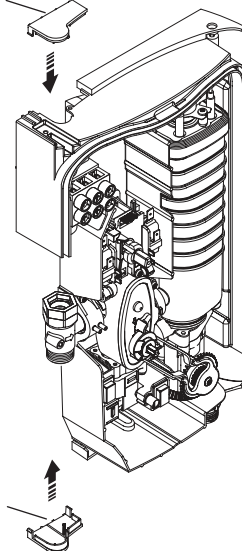

- 9 Secure the shower to the wall.

- 10** Connect the inlet supply pipe to the inlet connector using the compression nut and olive (supplied). Always provide mechanical support when making plumbing connections. Upon completion of the installation ensure connections and back case are not under any stress due to misaligned pipework or electrical cables.

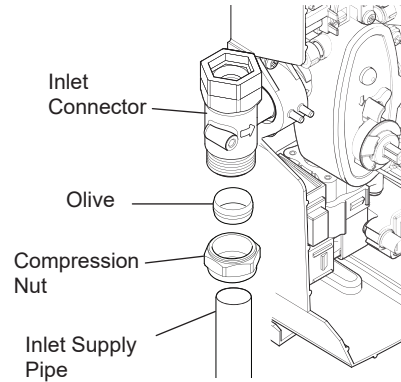

- 11** Turn on the water supply and check for leaks.

- 12** Strip back sufficient outer cable insulation to enable routing to terminal block.

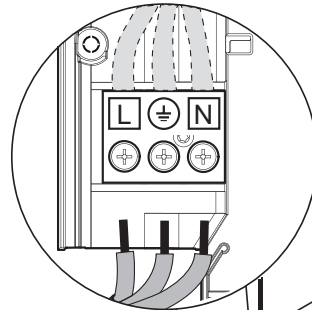

- 13** Fit an earth sleeve to the earth wire.

- 14** Loosen the screws in the terminal block and insert the wires.

L (Live) = Brown wire

PE (Protective Earth) =
Green /Yellow sleeved wire

N (Neutral) = Blue wire

- 15** Tighten the screws in the terminal block, ensure the wires are secure and tight.

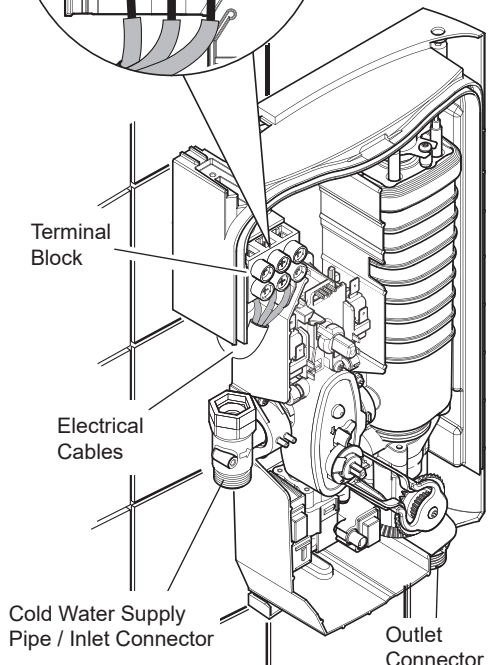

16 Ensure the earth bonding complies with relevant regulations.

17 Replace the service tunnel.

18 Ensure the control dials are aligned with the spindles and replace the cover.

19 Tighten the three cover screws.

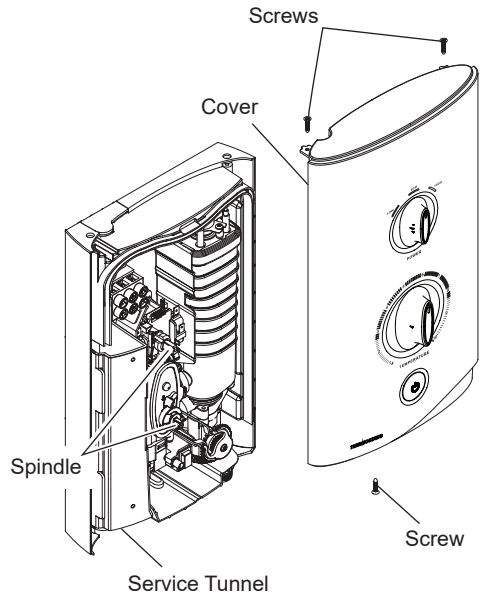

20 **Do not** use alternative screws to secure the cover. This can cause internal damage to the appliance. **Do not** seal around the back of appliance.

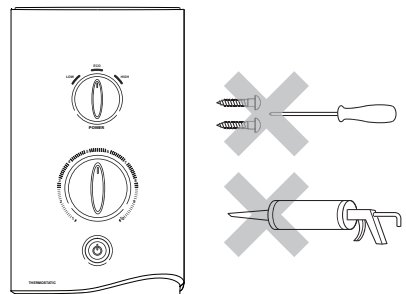

21 This completes the installation, follow the guidelines in section '**COMMISSIONING**' to prepare the shower for use.

Commissioning

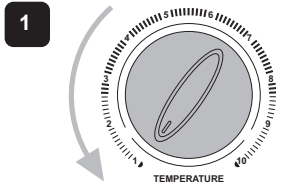

1 Turn temperature control to the cold position.

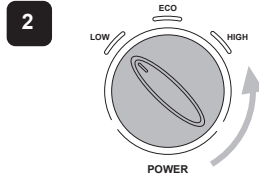

2 Turn power control to low.

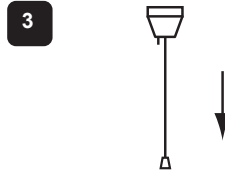

3 Switch on the electrical supply.

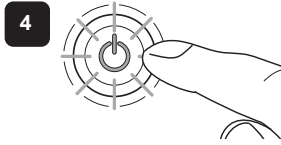

4 Push START/STOP button. Light in the button illuminates.

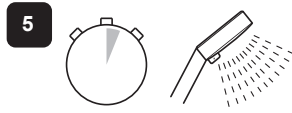

5 0 - 15 secs
Water flows freely within a few seconds, temperature remains cool.

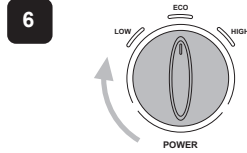

6 Turn power control to Eco.

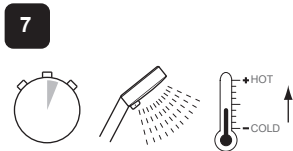

7 5 - 10 secs
Temperature will rise slightly.

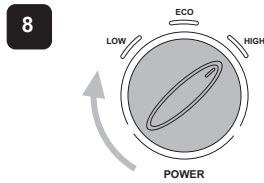

8 Turn power control to High.

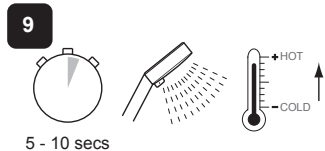

9 5 - 10 secs
Temperature will rise further.

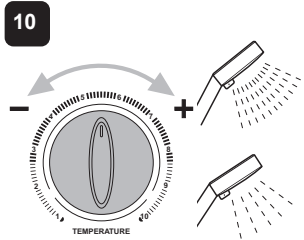

10 Adjust temperature as required. Flow rate will adjust automatically.

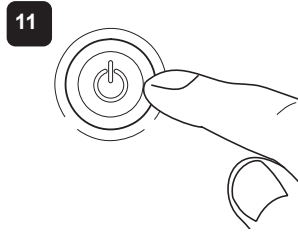

11 Push START/STOP button. Light in the button goes out.

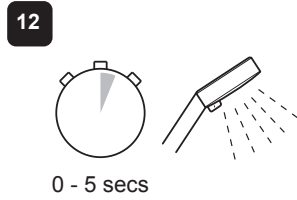

12 0 - 5 secs
The shower will purge water from its tank for a few seconds..

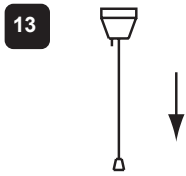

13 Switch off the electrical supply.

Note: A slight hissing sound may be heard from the Mira Escape during operation. High mains water pressure and high shower temperatures will affect the tone. This is quite normal in use.

Operation

Read the section “**Important Safety Information**” first.

1



Switch on the electrical supply.

2

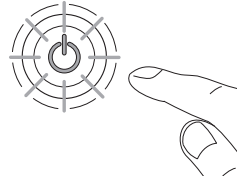

Push the **START/STOP** button to turn ON the appliance. Light in the button illuminates.

3

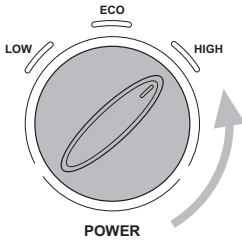

Turn the power control to the desired position.

4

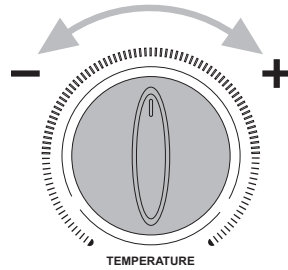

Adjust the temperature as required.

5

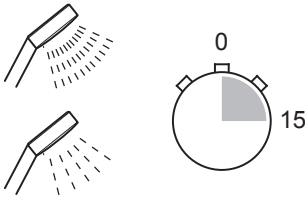

Allow 10 - 15 secs for any temperature adjustments to stabilise and reach the showerhead.

6

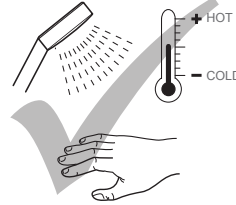

Check the water temperature before entering shower.

7

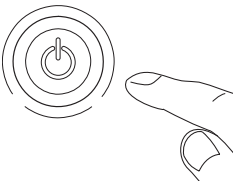

Push **START/STOP** button. Light in the button goes out and shower continues to run for a few seconds.

8



Switch off the electrical supply.

9

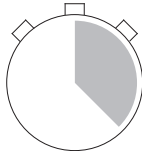

A small amount of water may continue to drain over a few minutes.

Warning! Turning the shower off and back on during showering may result in unstable temperatures at the showerhead. Always ensure the temperature has stabilised before re-using the shower.

Note: A slight hissing sound may be heard from the shower during operation. High mains water pressure and high shower temperatures will affect the tone. This is quite normal in use.

The Effect of Seasonal Changes

Incoming mains water temperature is not constant throughout the seasons of the year i.e. cooler during the winter, warmer during the summer. These changes can affect the outlet temperature of the shower, therefore the shower temperature may need to be increased or decreased to maintain the desired showering temperature.

					<p>For a cold shower select LOW</p>
					<p>For a summer warm shower select ECO/HIGH</p>
					<p>For a winter warm shower select HIGH</p>
<p>Adjust the temperature as required. The flow rate will adjust automatically.</p>					

The Effect of Other Water Devices

Example of how shower temperature stabilises due to pressure changes.

Selected Showering Temperature

+ Showering temperature will stabilise to within 6°C band if other outlets are opened whilst showering, providing the minimum pressure does not fall below:
 - 70 kPa (0.7 bar) - 9 kW
 100 kPa (1.0 bar) - 10.8 kW

Water inlet pressure fluctuations due to other draw offs (e.g. flushing toilet) will cause the showering temperature to increase.

Fault Diagnosis

In the event of a malfunction of the shower, the troubleshooting information below provides details on possible causes and remedies that may be carried out by qualified, competent personnel.

Warning! There are no user serviceable components beneath the cover of the shower. Only qualified competent personnel should remove the front cover.

Symptom	Start/Stop Light is ON or OFF	Power Control Position	Possible Cause	Possible Remedy
Shower fails to operate.	OFF	ANY	<p>Isolator switch in the off position.</p> <p>Fuse blown or MCB/RCD tripped, indicating possible electrical fault.</p> <p>Service tunnel or cover not fitted correctly causing Start/Stop button to not operate.</p>	<p>Switch on electrical supply via the pullcord or wall mounted switch.</p> <p>Renew the fuse or reset the MCB/RCD. If fault persists, contact your installer.</p> <p>Check case inserts are cut and fitted correctly. Check services (electrical or plumbing) are not interfering with location of service tunnel or cover.</p>
Shower cycles from hot to cold.	ON	ECO/ HIGH	<p>Showerhead blocked.</p> <p>Hose kinked or blocked.</p> <p>Water pressure below minimum required for shower operation.</p> <p>Temperature control or power control setting too high.</p>	<p>Remove and descale showerhead.</p> <p>Check hose and replace if necessary.</p> <p>Make sure incoming mains water stopcock and/or shower isolating valve is fully turned on.</p> <p>Turn the power control to Eco or turn the temperature control until a cooler temperature is achieved.</p>
Unable to select a cool enough shower.	ON	ANY	<p>Due to the rise in mains water supply temperature, the power control setting may be too high.</p>	<p>Turn the power control to Eco or turn the temperature control until a cooler temperature is achieved.</p>

Symptom	Start/Stop Light is ON or OFF	Power Control Position	Possible Cause	Possible Remedy
Showerhead dripping.	OFF	ANY	Insufficient water supply pressure for shut off. Flow valve faulty.	Minimum static pressure to ensure shut off and prevent dripping is 20 kPa (0.2 bar). Note: If other appliances are operating, static pressure may drop below 20 kPa (0.2 bar). Contact local water company. Replace flow valve.
Low or no flow.	ON	ANY	Water supply pipework or inlet filter restricted by a blockage or partial blockage. Insufficient water supply pressure/flow for operation. Flow valve faulty. Heater tank excessively scaled. Showerhead blocked. Hose kinked or blocked. Other outlets (e.g. Toilet, garden hose, washing machine, etc.) drawing water while the shower is being used.	Flush supply pipe. Clean inlet filter. Contact local water company. Supply pressure must be a minimum of 70 kPa (0.7 bar). Note: If other appliances are operating, pressure may drop below 70 kPa (0.7 bar). Replace flow valve. Replace heater tank. In hard water areas consider the use of a water softener. Remove and descale showerhead. Check hose and replace if necessary. Turn off other appliances whilst shower is in use.
Operation of Temperature Control has little or no effect on water temperature.	ON	ECO/ HIGH	Showerhead blocked. Hose kinked or blocked. Flow valve faulty. Heater tank failure.	Remove and descale showerhead. Check hose and replace if necessary. Replace flow valve. Replace heater tank.

Symptom	Start/Stop Light is ON or OFF	Power Control Position	Possible Cause	Possible Remedy
No change in temperature between Low / Eco / High setting.	ON	ANY	Microswitch failure. Insufficient mains water pressure. Possible failure of flow valve, microswitch or heater tank.	Replace microswitch. Contact local water company. Use a suitable device to check the continuity of the microswitch or heater tank and replace parts as necessary.
Water will not turn off.	OFF	ANY	Flow valve, solenoid or Start / Stop switch faulty.	Replace as necessary.
Shower fails to produce hot water when set on Eco / High setting.	ON	ECO/ HIGH	Insufficient water supply. Possible failure of the microswitch or thermal switch.	Contact local water company. Use a suitable device to check the continuity of the microswitch or heater tank and replace parts as necessary.
Water leaks from the bottom of the case and there is no flow from the showerhead.	OFF	ANY	Hose kinked or blocked. The PRV has been triggered, (the shower has a pressure relief valve assembly to reduce damage if the outlet is blocked or the shower is frozen). When the relief valve operates a small rubber ball is ejected.	Check hose and replace if necessary. Replace heater tank.

User Maintenance

In the event of a malfunction of the shower, a fault finding table is provided in this guide detailing possible causes and remedies that may be carried out by non-qualified personnel.

WARNING! TO REDUCE THE RISK OF FIRE, ELECTRIC SHOCK, INJURY OR PRODUCT DAMAGE:

- There are no user serviceable parts inside the shower. Only qualified, competent personnel should remove the front cover, mains connections are exposed when the cover is removed.
- Switch the shower off at the isolator switch before performing any user maintenance or before cleaning the shower.

Cleaning

Always read the IMPORTANT SAFETY INFORMATION for your shower

Cleaning the showerhead

Many household and commercial cleaners, including hand and surface cleaning wipes contain abrasive and chemical substances that can damage plastics, plating and printing and should not be used. These finishes should be cleaned with a mild washing up detergent or soap solution, and then wiped dry using a soft cloth.

De-scaling the Showerhead and inspecting the hose and diffuser

It is IMPORTANT to keep the Showerhead and Hose clean and free from blockage to make sure your shower performs to its optimum. The showerhead MUST be regularly cleaned and the hose MUST be regularly inspected to ensure there is no internal collapse or blockage that could reduce the flow.

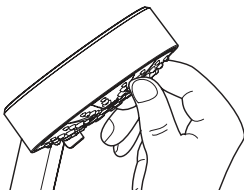

Use your thumb or a soft cloth to wipe any limescale from the soft nozzles.

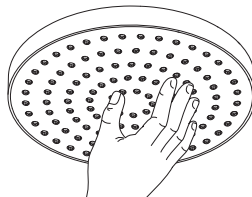

Unscrew the hose from the showerhead and the shower outlet.

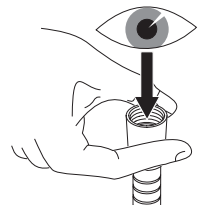

Inspect the hose.

Warning! Failure to keep the showerhead nozzles clear or inspect the hose for blockage or internal/external collapse can restrict the flow rate from the shower. This may cause damage to the shower or result in the temperature delivered to the user rising to unsafe levels with a risk of scalding. You MUST ALWAYS check the temperature before using the shower.

Servicing

Warning! There are no user serviceable parts inside the shower. Servicing of the shower must only be carried out by qualified, competent personnel following the instructions provided in this guide and those provided with any spare part. Before replacing any parts, ensure that the underlying cause of the malfunction has been resolved.

Cleaning the Inlet Filter

Warning! Isolate the electrical and water supplies before removing the cover.

- 1 Remove the shower hose.

Note: Retain the hose washer for further use
- 2 Remove the three screws that hold the cover on the shower and remove the cover.
- 3 Remove the service tunnel from the shower.
- 4 Use a suitable spanner to remove the filter from the inlet connector assembly. Hold a wrench across the flats of the inlet connector assembly to prevent damage to the connector, whilst removing the filter.
- 5 Remove the filter and rinse under a running tap to remove any lodged particles. If necessary, use a kettle descalent in accordance with the manufacturer's instructions.
- 6 Refit the components in reverse order.

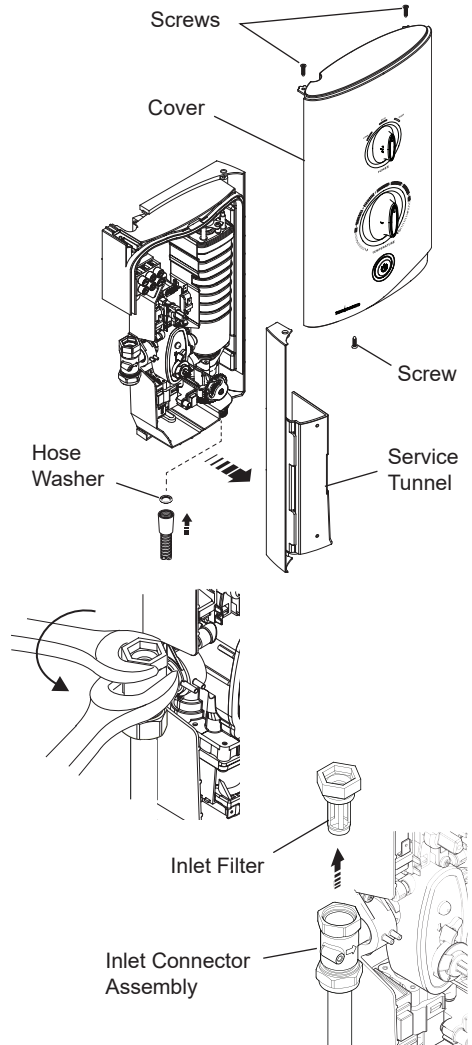

Spare Parts

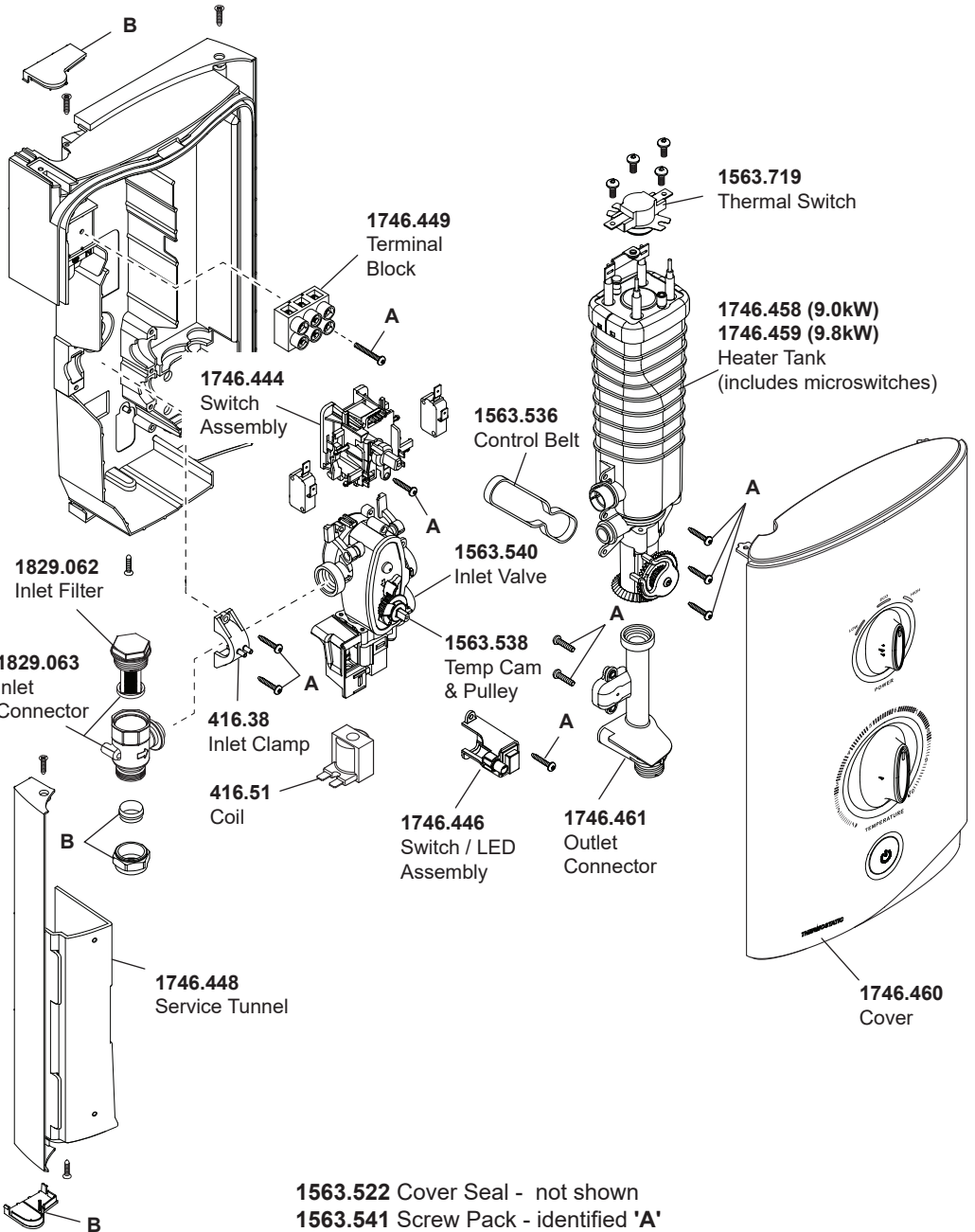

1563.522 Cover Seal - not shown
1563.541 Screw Pack - identified 'A'
1746.456 Component Pack - identified 'B'

Notes

Notes

Customer Support

Guarantee

Your product has the benefit of our manufacturer's guarantee which starts from the date of purchase. This guarantee only applies in the United Kingdom and Republic of Ireland.

Activating Your Guarantee

Registering your guarantee is quick and simple. To ensure your product is covered, please register online.



Scan the QR code to activate your guarantee now or call 0800 5978551 within 30 days of purchase (UK only).

What is Covered:

- The guarantee applies solely to the original installation under normal use.
- The product must be installed and maintained in accordance with the instructions given in this guide.
- Servicing must only be undertaken by us or our appointed representative.
- Repair under this guarantee does not extend the original expiry date. The guarantee on any replacement parts or product ends at the original expiry date.
- For shower fittings or consumable items we reserve the right to supply replacement parts only.

The guarantee does not cover:

- Call out charges for non product faults (such as damage or performance issues arising from incorrect installation, improper use, inappropriate cleaning, lack of maintenance, build up of limescale, frost damage, chemical attack, corrosion, system debris or blocked filters) or where no fault has been found with the product.
- Water or electrical supply, waste and isolation issues.
- Routine maintenance or replacement parts to comply with the requirements of Building / Plumbing / Electrical Standards or Schemes.
- Compensation for loss of use of the product or consequential or indirect loss of any kind.
- Damage or defects caused if the product is repaired or modified by persons not authorised by us or our appointed representative.
- Accidental or wilful damage.
- Products purchased ex-showroom display.
- Disinfection or descaling to reduce bacterial growth or contamination.

What to do if something goes wrong

If your product is not working correctly please refer to this manual for fault diagnosis and to check that it is installed and commissioned in accordance with our instructions. If this does not resolve the issue, our Customer Services team are here to help get you back up and running. To help us solve your problem quickly, please have your product name, power rating (if applicable) and date of purchase to hand.

Visit www.mirashowers.co.uk

Visit our website to register your guarantee, book a service visit, diagnose faults and purchase products.

Spares and Accessories

We stock a full range of spare parts and fittings and are all available to purchase either online or over the phone. Our online spare parts selector tool will help you quickly and easily identify the spare part for your product.

Visit www.mirashowers.co.uk/parts-accessories

Replacements and Repairs

In the unlikely event that your product needs a repair, our nationwide repairs and installation team are here to help. You can book a convenient date and time online.



Scan the QR code to book a service visit now or visit www.mirashowers.co.uk/support/repair-services/repair-service

We also offer a comprehensive replacement service for when your product needs a little refresh, visit our website or contact our team for more information on our replacement services.

Help us improve

Your experience is important to us and your review (whether good, bad or otherwise) will be posted on Trustpilot.com immediately to help other people make more informed decisions.

Visit uk.trustpilot.com/review/www.mirashowers.co.uk

Need to get in touch?

UK

T: 0800 001 4040
E: askus@mirashowers.com
www.mirashowers.co.uk

Eire

T: 01 531 9337
E: customerserviceire@mirashowers.com
www.mirashowers.ie

Mira is a registered trade mark of Kohler Mira Limited.

The company reserves the right to alter product specifications without notice.

Registered Office:
Cromwell Road,
Cheltenham,
Gloucestershire
GL52 5EP

EU Importer address
K/E S.A.S.
3 rue de Brennus,
93631, La Plaine Saint-Denis,
France



mira
SHOWERS