

9.0 & 9.8 KW

mira *Sport* Thermostatic

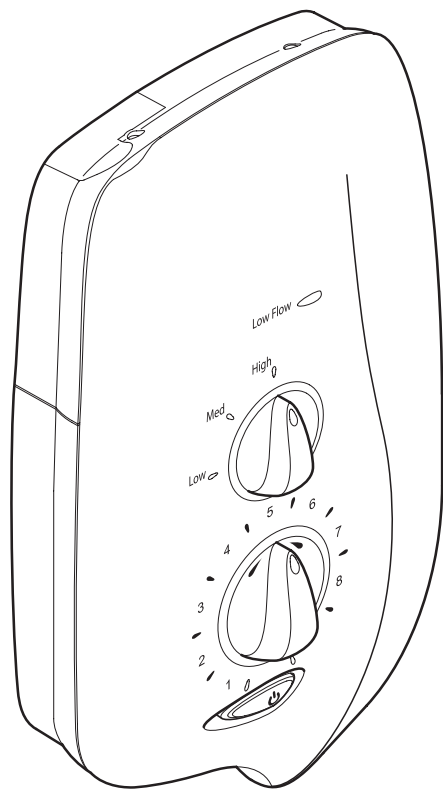

MIRA SPORT THERMOSTATIC

ELECTRIC SHOWER

Installation & User Guide

These instructions are to be left with the user

CONTENTS

Patents and Design Registration	2
Introduction	3
Guarantee	3
Important Safety Information	4
Pack Contents Checklist	6
Specifications	7
Installer Instructions	8
Plumbing Checklist.....	8
Electrical Checklist	10
Installation	12
Commissioning	14
User Instructions	16
Thermostatic Control	17
Fault Diagnosis.....	20
Maintenance.....	24
Inlet Filter - Cleaning/Renewing	24
Dimensions	25
Spare Parts	26
Accessories	28
Wiring Diagram	29
Customer Service.....	Back Page

Patents and Design Registration

Design Registration:	000373543-001-004
Patents:	GB: 2 341 667, 2 404 000, 2 428 286 Ireland: 82835
Patent Applications:	UK: 2 427 460 Ireland: 2004/0483, 2006/0462, 2008/0289

INTRODUCTION

Thank you for purchasing a quality Mira product. To enjoy the full potential of your new product, please take time to read this guide thoroughly. Having done so, keep it handy for future reference.

The Mira Sport Thermostatic is an electric shower with separate controls for power selection and temperature/flow adjustment. A unique thermostatic valve stabilises temperature changes caused by water pressure fluctuations. These can result from taps being turned on or off, or toilets being flushed. Individual lights indicate "ON/OFF" and "LOW FLOW".

Mira Sport models covered by this guide:

Mira Sport Thermostatic 9.0 - A 9.0 kW 240 V AC (8.3 kW 230 V AC) heater. Available in white/chrome finish.

Mira Sport Thermostatic 9.8 - A 9.8 kW 240 V AC (9.0 kW 230 V AC) heater. Available in white/chrome finish.

Recommended Usage	
Domestic	✓
Light Commercial	✓
Heavy Commercial	✗
Healthcare	✗

Guarantee

For **domestic installations**, Mira Showers guarantee the Mira Sport Thermostatic 9.0 & 9.8 kW against any defect in materials or workmanship for a period of **two** years from the date of purchase (shower fittings for one year).

For **non-domestic installations**, Mira Showers guarantee the Mira Sport Thermostatic 9.0 & 9.8kW against any defect in materials or workmanship for a period of **one** year from the date of purchase.

For terms and conditions refer to the back cover of this guide.

If you experience any difficulty with the installation or operation of your new Electric Shower, please refer to '**Fault Diagnosis**', before contacting Kohler Mira Ltd. Our telephone and fax numbers can be found on the back cover of this guide.

IMPORTANT SAFETY INFORMATION

WARNING

TO REDUCE THE RISK OF FIRE, ELECTRIC SHOCK OR INJURY:

1. Installation of this shower must be carried out in accordance with these instructions, and must be conducted by competent personnel.
2. Isolate the electrical and water supplies before commencing installation. The electricity must be switched off at the consumer unit and the appropriate circuit fuse removed, if applicable.
3. The electrical installation must comply with BS 7671 (commonly referred to as the IEE Wiring Regulations) and all relevant building regulations, or any particular regulation or practice specified by the local electricity supply company.
4. The plumbing installation must comply with all national or local water regulations and all relevant building regulations, or any particular regulation or practice specified by the local water supply company.
5. This shower is intended to be permanently connected to the fixed electrical wiring of the mains system. A separate supply must be provided from the consumer unit to the shower.
6. This shower must be provided with means for disconnection that is incorporated into the fixed wiring in accordance with the relevant local wiring regulations. The isolating switch must be local to the appliance and may be a ceiling mounted pullcord type or a wall mounted switch fitted in an appropriate zone area.
7. In accordance with BS7671 a 30mA Residual Current Device (RCD) **must** be fitted. This may be part of the consumer unit or a separate unit.
8. This shower must be earthed. Ensure any supplementary bonding complies with the relevant regulations.
9. Ensure all electrical connections are tight, to prevent overheating.
10. This shower must not be fitted where it may be exposed to freezing conditions. Ensure that any pipe-work that could become frozen is properly insulated.
11. This shower is not suitable for areas with high humidity or temperature (i.e. steam rooms and saunas).
12. Mains connections are exposed when the cover is removed, only a competent person should remove the front cover. We recommend any maintenance work is carried out by a Mira Service Engineer or suitably qualified tradesperson. There are no user serviceable parts inside the shower.
13. **DO NOT** switch on if water leaks from the main enclosure. Isolate the electrical supply to the shower immediately.
14. **DO NOT** switch on if there is a possibility that the water in the shower is frozen.
15. The outlet must not be connected to any tap, outlet control or showerhead other than those specified for use with this shower. Only Kohler Mira recommended accessories should be used.

16. Electric showers can deliver scalding temperatures if not operated, installed or maintained in accordance with the instructions, warnings and cautions contained in this guide and on or inside the shower.
17. Rapid or excessive operation of the shower controls may result in high or unstable outlet water temperatures. Operate controls gradually and allow 10-15 seconds to stabilise checking the temperature before entering the shower.
18. This shower is not intended for use by persons (including children) with reduced physical, sensory or mental capabilities, or lack of experience and knowledge, unless they have been given supervision or instruction concerning the use of the shower by a person responsible for their safety.
19. Children should be supervised to ensure that they do not play with the shower.
20. Always switch off the shower at the electrical isolating switch when not in use.
21. The showerhead must be de-scaled regularly.
22. **DO NOT** allow the handset to spray water directly on to the shower. Eg. When cleaning shower control.
23. If the shower is not to be used for a long period, the water supply to the shower must be isolated. If the shower or pipe-work is at risk of freezing during this period, they should also be drained of water.

If any of the following conditions occur, isolate the electricity and water supplies and refer to “To contact us”, on the back page of this guide.

- If the cover is not correctly fitted and water has entered the shower case
- If the case is damaged
- If the shower begins to make an odd noise, smell or smoke
- If the shower shows signs of a distinct change in performance indicating a need for maintenance
- If the shower is frozen

PACK CONTENTS CHECKLIST



Tick the appropriate boxes to familiarize yourself with the part names and to confirm that the parts are included.

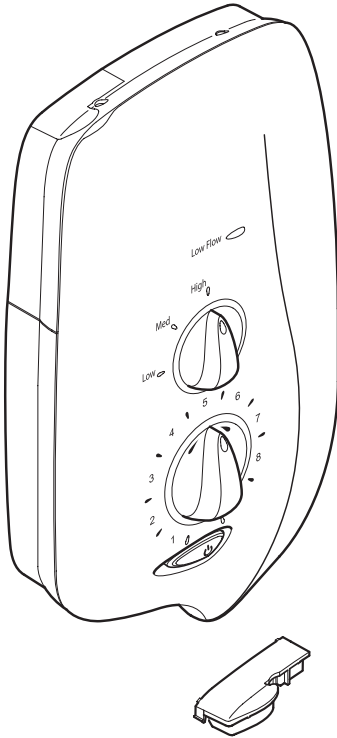

1 x Mira Sport Thermostatic 9.0 kW or 9.8 kW



1 x Olive

1 x Compression Nut



3 x Fixing Screws



3 x Wall plugs

2 x Case Inserts

Documentation

- 1 x Customer Support Brochure
- 1 x Installation Template
- 1 x Installer Checklist

SPECIFICATIONS

1. Plumbing

- 1.1. Minimum maintained inlet pressure of 70 kPa (0.7 bar). 100 kPa (1.0 bar) recommended for satisfactory operation.
- 1.2. Maximum static inlet pressure of 1000 kPa (10 bar).
- 1.3. Minimum static inlet pressure of 20 kPa (0.2 bar) to keep the inlet valve closed.

2. Electrical

- 2.1. The Mira Sport Thermostatic 9.0 kW @ 240 V AC (8.2 kW @ 230 V AC) requires a 40 Amp circuit protection device.
The Mira Sport Thermostatic 9.8 kW @ 240 V AC (9.0 kW @ 230 V AC) requires a 45 Amp circuit protection device.
- 2.2. The terminal block will accept cable up to 16 mm² (9.0 and 9.8 kW).
- 2.3. The Mira Sport Thermostatic is suitable for installation within zone 1 and is rated IPx4.

3. Standards and Approvals

- 3.1. The Mira Sport Thermostatic complies with all relevant directives for CE marking.

INSTALLER INSTRUCTIONS

Read the section “Important Safety Information” first.

Plumbing Checklist

1. Minimum maintained inlet pressure = 70 kPa (0.7bar), 100 kPa (1.0 bar) recommended.
Maximum static inlet pressure = 1000 kPa (10 bar).
2. Water treatment device (if required).
3. Free flowing isolating valve.
4. Positioned over water catchment area.
5. Fitted to finished wall surface.
6. No sharp hose kinks.
7. Fittings should be positioned with a greater than 25 mm gap. If this is not achievable then a outlet double checkvalve **must be** fitted.
8. Supply pipework flushed clear.
9. Watertight inlet connection and fittings.
10. Case inserts fitted and Cover secured correctly.

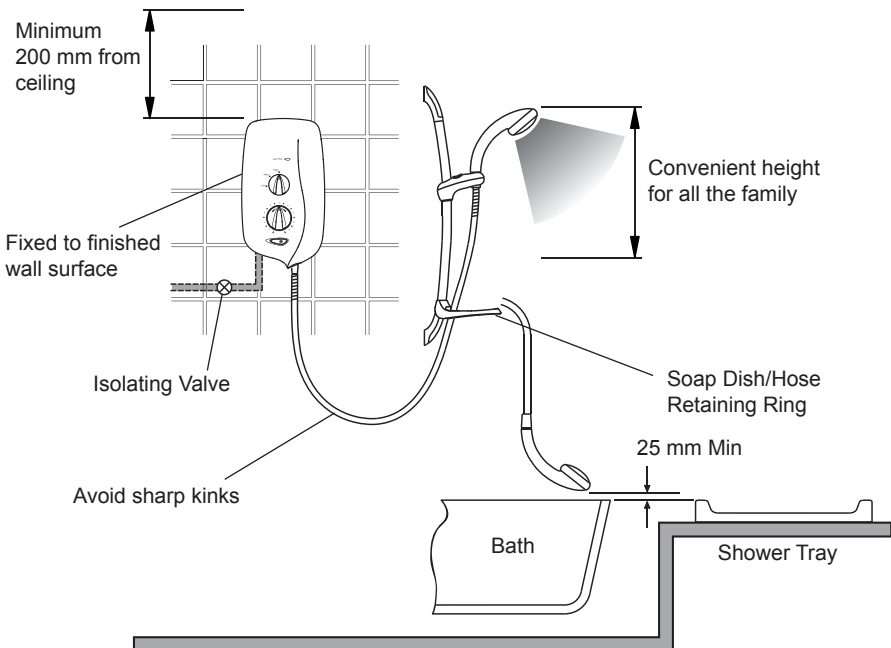

Plumbing (checklist in detail)

1. The appliance is designed to operate with a minimum maintained inlet pressure of 70 kPa (0.7 bar), 100 kPa (1.0 bar) recommended, up to a maximum static inlet pressure of 1000 kPa (10 bar).
2. When installed in very hard water areas (above 200 ppm temporary hardness) your installer may advise the installation of a water treatment device, to reduce the effects of limescale formation. Your local water company will be able to advise the hardness of water in your area.
3. It is recommended that a non-restrictive (free flowing) isolating valve is fitted as part of the cold water supply pipe to allow the complete maintenance of the Mira Sport Thermostatic. **Do not** use a valve with a loose washer plate (jumper) as this can lead to a build up of static pressures.
4. The appliance is suitable only for installation within the shower area. It is fitted with a pressure relief device and must be positioned over a water catchment area with the controls at a convenient height for all users.
5. The appliance must be fitted onto a finished flat and even wall surface (this wall surface should be tiled or waterproofed). **Do not** fit the appliance to the wall and tile up to the case. For safety requirements, an air gap must be left behind the appliance.
6. Avoid layouts where the shower hose will be sharply kinked. This may reduce the life of the hose.
7. A Soap Dish/Hose Retaining Ring is supplied to prevent the handset from dropping below the spill-over level of the bath or shower, which could lead to contamination from back-siphoning. The supplied Hose Retaining Ring should meet the great majority of user requirements for shower installations with flexible outlet fittings. However, there will be occasions when it will not provide a suitable solution. In these instances an outlet double checkvalve, e.g. a Mira DCV-H, must be fitted. This will increase the required supply pressure typically by 10 kPa (0.1 bar) refer to section: '**Accessories**'.
8. Supply pipework must be flushed to clear debris before connecting to the appliance.
9. To avoid damage to the case when soldered fittings are used, pre-solder the pipework and fittings before connecting them to the inlet connector assembly. Refrain from applying excessive force when making any connections. Always provide mechanical support when making the plumbing connections.
10. The appliance is fitted with a brass inlet compression assembly for connecting to a 15 mm supply pipe from the top, bottom or back. Double checkvalves, fitted in the inlet supply to the appliance, cause a pressure build-up, which could exceed the maximum static inlet pressure and damage the appliance.

Read the section “**Important Safety Information**” first.

Electrical Checklist

1. Electrical supply fuse and consumer unit are adequate for the product.
2. Shower unit is earthed.
3. The minimum required supply cable size must conform to BS 7671.
4. Double pole isolating switch.
5. Do not twist live or neutral cable cores.
6. Electrical connections are tightly secured.
Do not strain terminal block.
7. Plumbing supply completed before electrical supply is turned on.

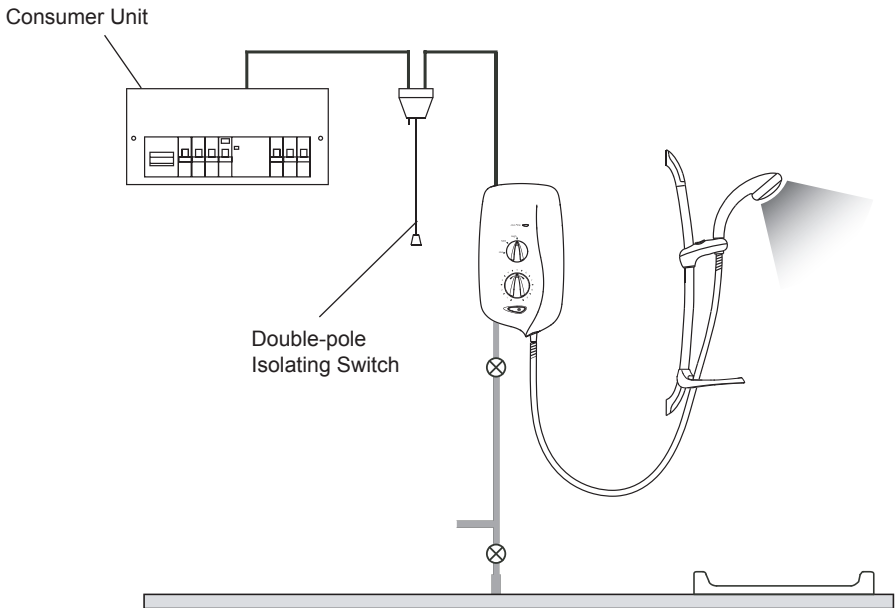

Electrical (checklist in detail)

1. In a domestic installation, the rating of the electricity supplier's fuse and the consumer unit must be adequate for the additional demand. All Mira Sport electric showers are high power units, therefore it is essential to contact your electricity supplier to ensure that the supply is adequate for the product. Voltage drop due to local heavy demand will reduce the shower's performance.
2. The Mira Sport Thermostatic **must be earthed** by connecting the supply-cable earth conductor to the earth terminal.

Supplementary bonding: Within the bathroom or shower room, all accessible conductive parts of electrical equipment and extraneous conductive parts (metal parts) that are likely to introduce earth potential, must be electrically bonded to earth using a minimum cable size of 4.0 mm² if the cable is not mechanically protected (2.5 mm² if mechanically protected).

3. Supply cable - see opposite.
4. **As a guide only**, and in accordance with BS 7671, we recommend close circuit protection:
i.e. 9.0 kW = 40 Amp
 9.8 kW = 45 Amp

A 30 mA Residual Current Device (RCD) **must** be included in the electrical circuit. This may be part of the consumer unit or a separate unit.

A separate, permanently connected supply is taken from the consumer unit to the appliance through a double-pole isolating switch, which has at least 3 mm of contact separation. The switch can be a ceiling mounted pullcord type within the shower room or a wall mounted switch in an adjacent room.

5. **Do not** twist the individual cable cores of either the live or neutral conductors, as this will prevent them from entering the terminal block
6. **Do not** exert strain on the terminal block. Make sure that the electrical connections are tightly screwed down.
7. **Do not** turn on the electrical supply until the plumbing has been completed.

INSTALLATION

Read the section “Important Safety Information” first.

1. 

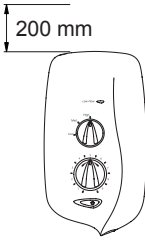
Electrical supply is turned off at the mains.
2. 

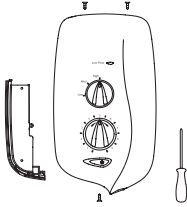
200 mm minimum gap from ceiling.
3. 

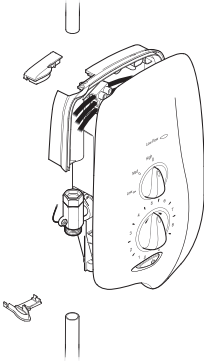
Remove three screws.
4. 

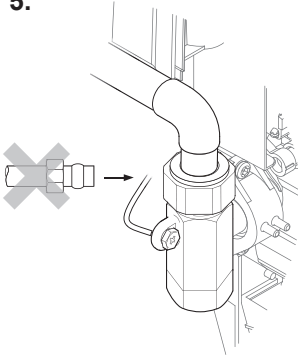
Remove Cover and determine supply pipe position.
5. 

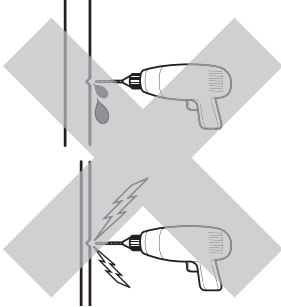
For back inlet use soldered elbow.
Do not trap green wire.
6. 

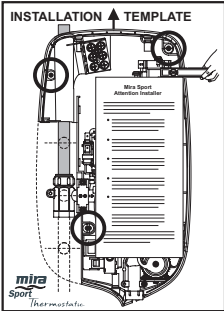
Caution! Do not drill into buried cables or pipes.
7. 

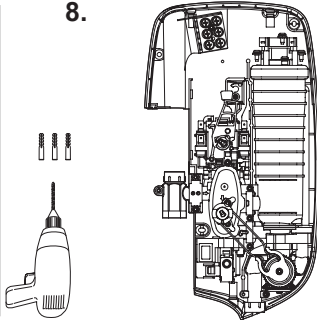
Drill and plug* the three holes using template.
8. 

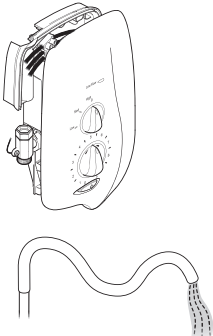
Fix appliance to wall.
9. 

Flush a minimum of 10 litres through pipework.

* Alternative fixings for some wall structures are not supplied.

10.

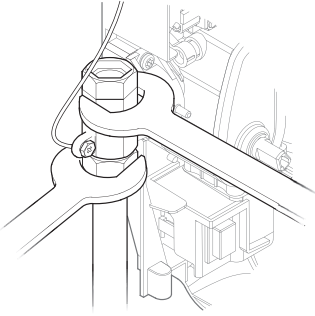

Connect supply pipe.
Do not overtighten!

11.

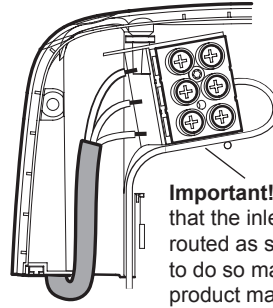

Important! Make sure that the inlet earth wire is routed as shown. Failure to do so may cause product malfunction.

Feed cable into Case. Fit Earth sleeve (not supplied) and strip insulation.

Do not twist cable cores.

12.

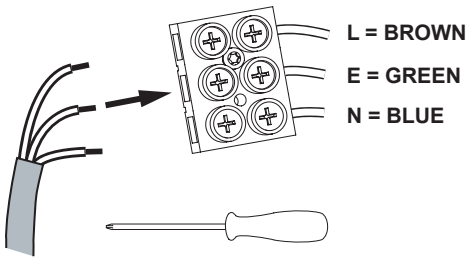

Firmly connect the conductors. **Do not** exert strain on the terminal block.

13.

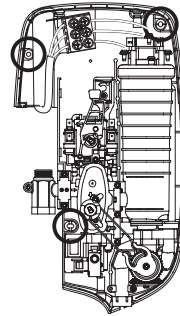

Make sure wires are clear of all mounting holes.

14.

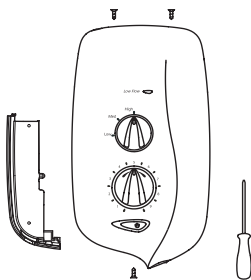

Refit the Service Tunnel and Cover. Make sure they fit correctly.
Do not overtighten screws.

15.

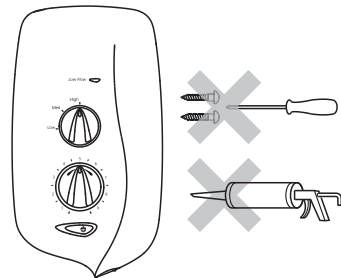

Do not use alternative screws to secure the Cover. This can cause internal damage to the appliance.
Do not seal around the back of appliance.

COMMISSIONING

Before carrying out the commissioning procedure install the Shower Fittings, refer to the Shower Fittings Installation and User Guide.

If you are unsure how an electric shower works, please read through the User Instructions section before continuing.

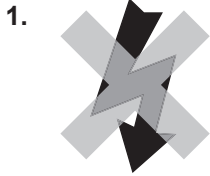

Electrical supply is turned off at the mains.

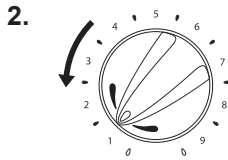

Turn control to full cold.

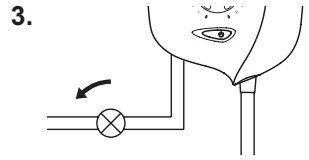

Turn water supply fully on.



Check for water leaks.

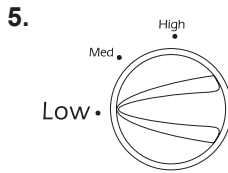

Set control to LOW.

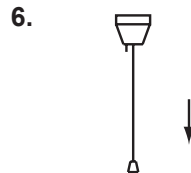

Switch on electrical supply.

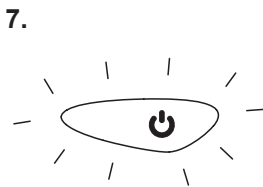

Push START button. Light on the button comes on.

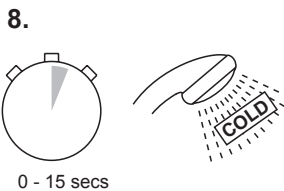

Water will be flowing at a cool temperature.

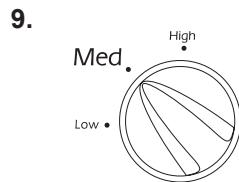

Set control to MEDIUM.



5 - 10 secs

The temperature will rise slightly.

11.

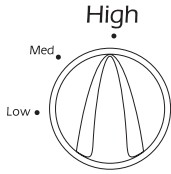

Set control to HIGH.

12.

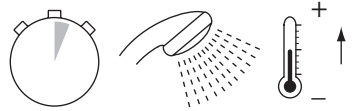

5 - 10 secs

The temperature will rise further.

13.

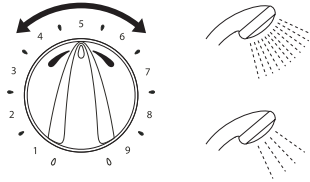

Adjust temperature as required.
Flow rate will adjust automatically.

14.

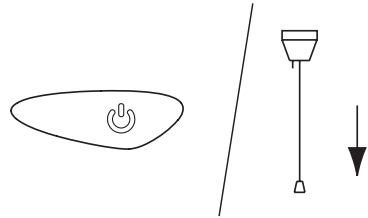

Press STOP button, light on the button goes out. Shower flow will continue for a few seconds before stopping. Isolate power.

15.

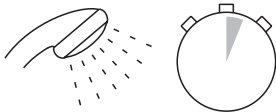

0 - 5 secs

The shower will purge water from its tank for a few seconds.

16.



Residual water may drain over a few minutes.

Note! A slight hissing sound may be heard from the Mira Sport during operation. High mains water pressure and high shower temperatures will affect the tone. This is quite normal in use.

USER INSTRUCTIONS

How Your Electric Shower Works

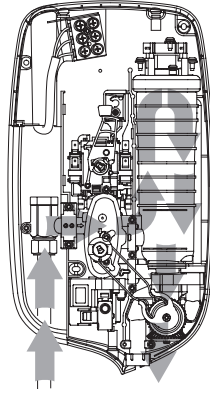

Heated water is produced by adjusting the flow of cold water passed through a heater tank.

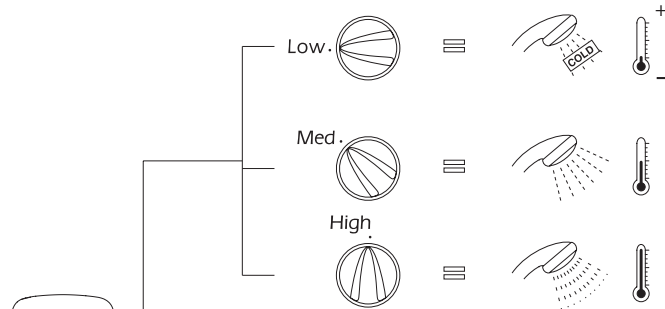

The shower has three heater settings.

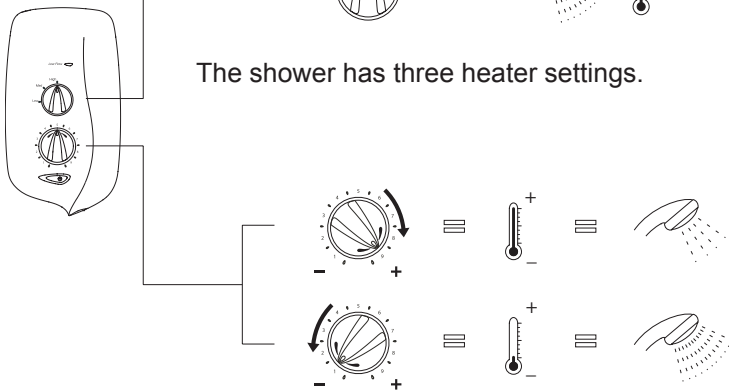

The warmer the shower, the lower the flow rate and vice versa.

THERMOSTATIC CONTROL

Thermostatic (Temperature-Stable)

The shower's top priority is to keep the desired water temperature constant. Electric showers with thermostatic control are able to keep a stable temperature across the range from hot to cold, whilst also dealing with fluctuations in electrical and water supplies. As a result, there is a **temperature limit** the shower cannot go beyond. For safety, this temperature is factory set and cannot be adjusted to make the shower hotter or colder.

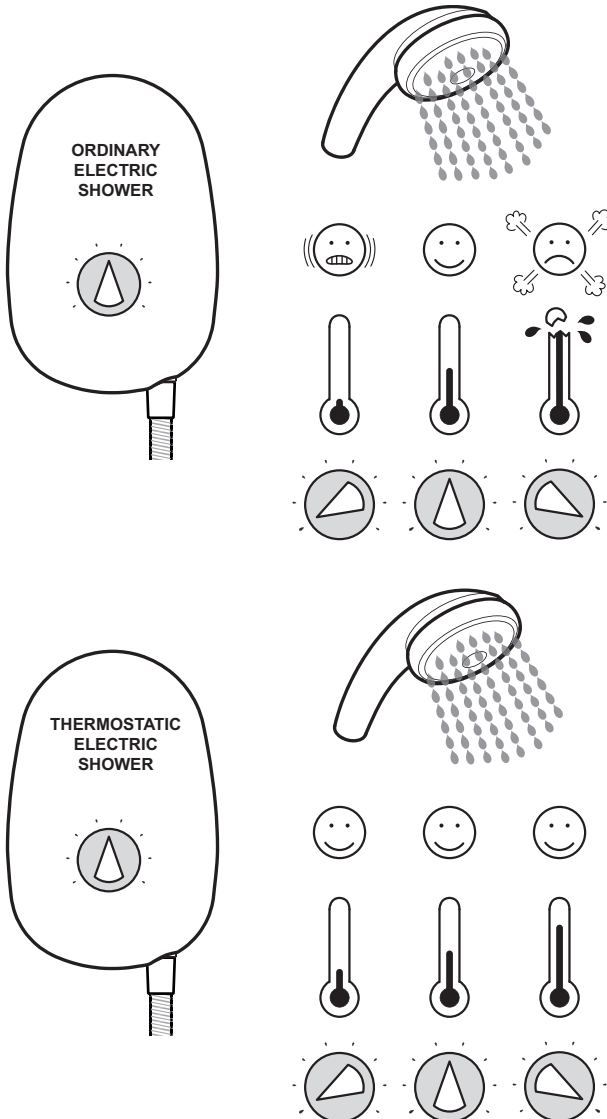

The Effect of Seasonal Changes

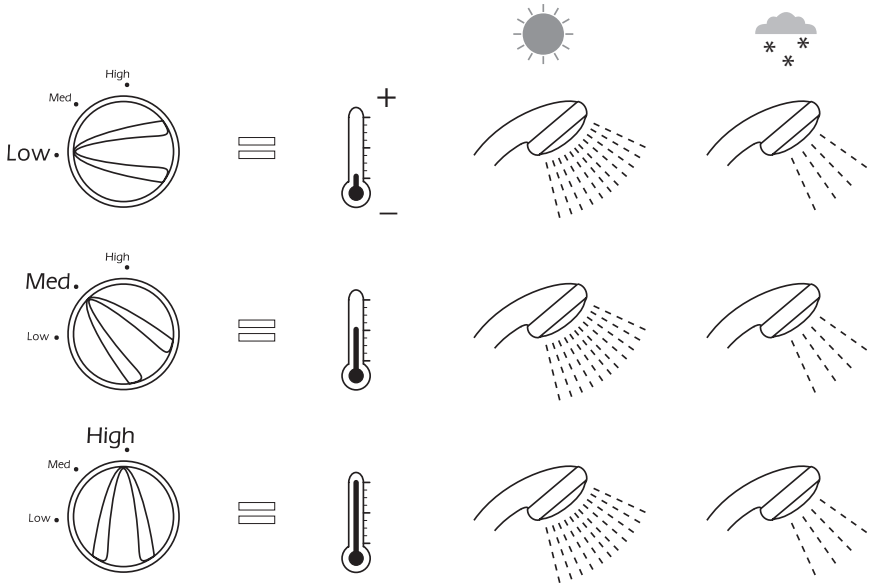

For a cold shower select LOW.

For a summer warm shower select MEDIUM.

For a winter warm shower select HIGH.

During extremes of mains water supply temperature, adjust heater setting to obtain a better showering temperature.

The Effect of Other Water Devices

Example of how shower temperature stabilizes due to pressure changes.

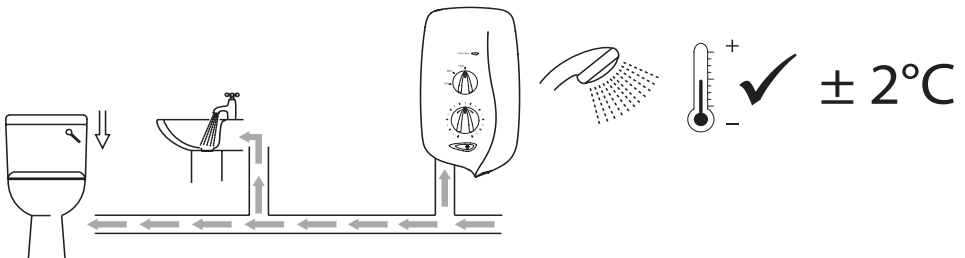

Water inlet pressure fluctuates due to other draw offs (e.g. flushing toilet). Shower temperature will be controlled to within $\pm 2^\circ\text{C}$ of the set temperature provided that the supply conditions remain within the required operating parameters (refer to section: '**Specifications**').

Using Your Shower

Read the section “Important Safety Information” first.

- 

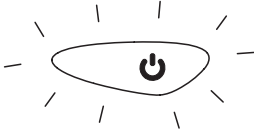
Switch on electrical supply.
- 

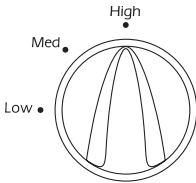
Press START button. Light on the button comes on.
- 

Set to desired position.
- 

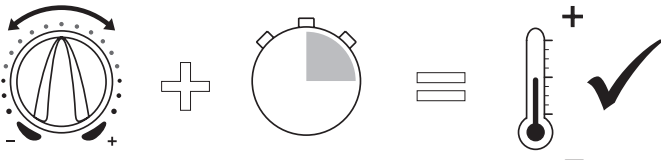
Check water temperature before entering shower.
- 

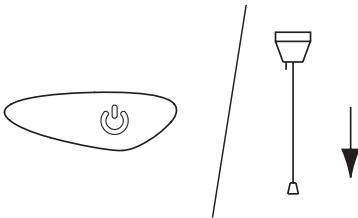
Allow 10-15 seconds for any temperature adjustments to reach the handset.
- 

Press STOP button, light on the button goes out. Shower flow will continue for a few seconds before stopping. Isolate power.
- 

A small amount of water may continue to drain over a few minutes.

FAULT DIAGNOSIS

The trouble shooting information tabled below gives details on probable causes and remedies should difficulties be encountered whilst the shower is in operation.

Warning! There are no user serviceable components beneath the cover of the appliance. **Only a competent tradesperson should remove the front cover!**

Symptom	Power Light	Low Flow Light	Heater Low/ Med/ High	Probable Cause	Possible Remedy
Appliance fails to operate.	Off	Off	Any	Electrical supply isolated at double pole switch.	Switch on electrical supply via the pullcord or wall mounted switch.
	Off	Off	Any	Fuse blown or MCB/RCD tripped, indicating possible electrical fault.	Renew the fuse or reset the MCB/RCD. If fault persists, contact your installer.
Shower cycles from hot to cold.	On	On	Med/ High	Handset blocked.	Remove and clean.
	On	On	Med/ High	Water pressure below minimum required for appliance operation.	Make sure incoming mains water stopcock and/or appliance isolating valve is fully turned on.
	On	Off	Med/ High	Temperature dial or heater setting too high.	Turn the heater selector knob to medium setting or turn the temperature control until a cooler temperature is achieved.
	On	Off	Med/ High	Thermostatic mechanism is faulty or damaged.	Replace.

Symptom	Power Light	Low Flow Light	Heater Low/ Med/ High	Probable Cause	Possible Remedy
Unable to select a cool enough shower.	On	Off	High	Due to a rise in mains water supply temperature, the heater setting may be too high.	Turn the heater selector knob to Medium and adjust the temperature control until a suitable temperature is achieved.

All the following remedies must be performed by a competent tradesperson!

Hand set dripping.	Off	Off	Any	Insufficient water supply pressure for shut off.	The minimum static pressure to ensure shut off and prevent dripping is 20 kPa (0.2 bar). Note! If other appliances are operating, static pressure may drop below 20 kPa (0.2 bar). Contact local water company. Renew inlet valve.
	Off	Off	Any	Inlet valve faulty	Replace.
Low or no flow.	On	On	Any	Water supply pipework or inlet filter restricted by a blockage or partial blockage.	Flush supply pipe. Clean inlet filter.
	On	On	Any	Insufficient water supply pressure/ flow for operation.	Contact local water company. Supply pressure must be a minimum of 70 kPa (0.7 bar). Note! If other appliances are operating, pressure may drop below 70 kPa (0.7 bar).

Symptom	Power Light	Low Flow Light	Heater Low/Med/High	Probable Cause	Possible Remedy
Low or no flow. (continued...)	On	On	Any	Other outlets (e.g. toilet, washing machine, etc) drawing water whilst the shower is on.	Turn off other appliances whilst shower is in use.
	On	Off	Any	Handset blocked.	Remove and clean.
	On	Off	Any	Service tunnel or cover not fitted correctly causing Start/Stop button not to operate.	Check case inserts are cut and fitted correctly. Make sure electrical and plumbing services are not interfering with location.
	On	Off	Any	Inlet valve faulty.	Replace.
	On	Off	Any	Heater tank excessively scaled.	Replace. Consider the use of a water softener.
Operation of temperature control has little or no effect on water temperature.	On	On	Med/High	Handset or inlet filter blocked.	Remove and clean.
	On	Off	Med/High	Inlet valve faulty.	Replace.
	On	Off	Med/High	Heater tank failure.	Replace.
	On	Off	Med/High	Microswitch failure.	Replace.
	On	Off	Med/High	Thermostatic mechanism failure.	Replace.
	On	Off	Med/High	Temperature control belt.	Replace.

Symptom	Power Light	Low Flow Light	Heater Low/ Med/ High	Probable Cause	Possible Remedy
No change in temperature between Low/ Med/ High settings.	On	On	Any	Insufficient mains water pressure.	Contact local water company.
	Off	Off	Any	Possible failure of microswitch or heater tank.	Check the continuity of the microswitch or heater tank and replace parts as necessary.
Water will not turn off.	On	Off	Any	Inlet Valve, Solenoid, or Start/Stop switch faulty.	R e p l a c e a s necessary.
	On	On	Any	Supply pressure below 20 kPa (0.2 bar).	Contact local water company. Check mains water static pressure.
Appliance fails to produce hot water when set on Med/ High heater setting.	On	On	Med/ High	Insufficient water supply.	Contact local water company.
	On	Off	Med/ High	Possible failure of the Microswitch or Thermal switch.	Check the continuity of the Microswitch or Heater Tank and replace parts as necessary.
	On	Off	Med/ High	Heater Tank failure.	Replace.

MAINTENANCE

Inlet Filter - Cleaning/Renewing

Read the section “Important Safety Information” first.

- 

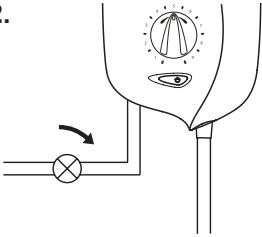
1. Electrical supply is turned off at the mains.
- 

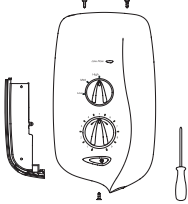
2. Turn water supply fully off.
- 

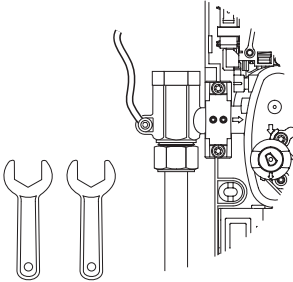
3. Remove three screws, Cover and Service Tunnel.
- 

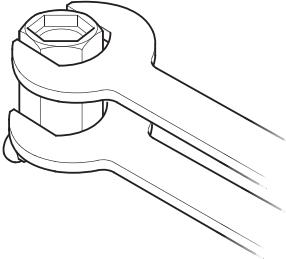
4. Hold a wrench across the flats of the metal connector. Unscrew the filter using another wrench as shown. Clean or renew the Filter as necessary. Refit in reverse order making sure the Filter is screwed fully home.
- 

5. **Do not** overtighten.

DIMENSIONS

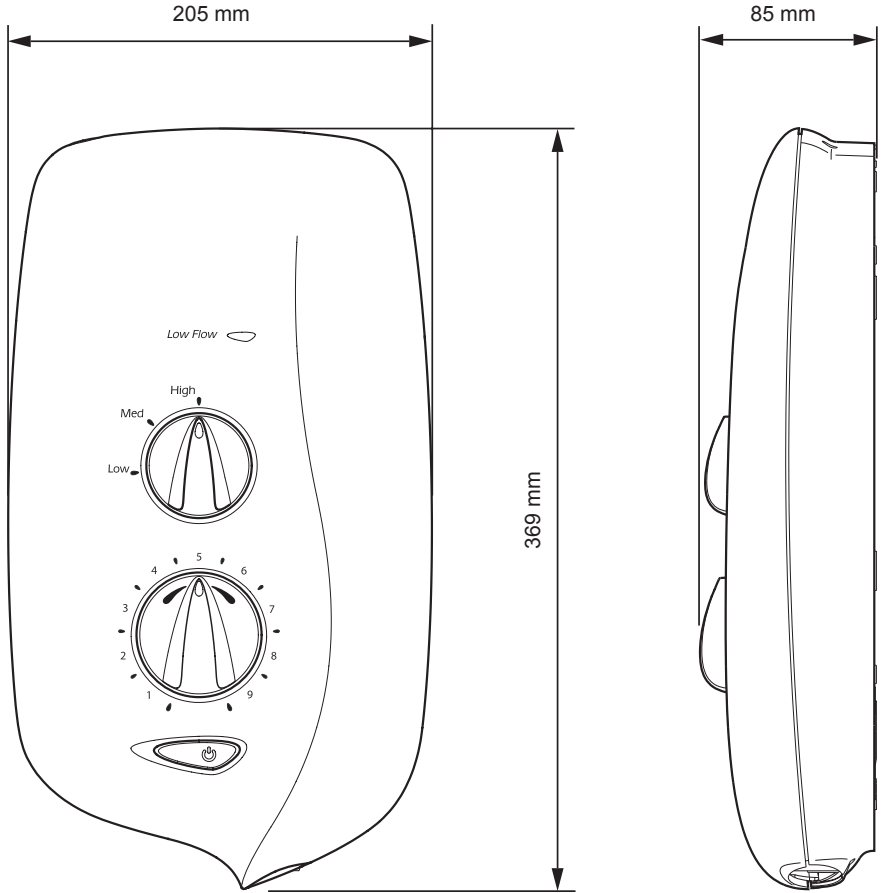

SPARE PARTS

405.58	Inlet Connector Assembly
406.27	Inlet Filter (with 'O' seal fitted)
416.38	Clamp Bracket (Inlet)
416.48	Latching Switch
416.51	Solenoid Coil
872.01	Microswitch N/O - 2 pin
872.28	Microswitch C/O - 3 pin
1563.509	Switching Assembly
1563.519	Terminal Block Assembly
1563.522	Cover Seal (not shown)
1563.532	Thermostatic Valve/Heater Tank 9.0 kW 240 V AC
1563.533	Thermostatic Valve/Heater Tank 9.8 kW 240 V AC
1563.534	Outlet Connector Assembly
1563.536	Temperature Control Belt Thermostatic
1563.538	Temperature Cam & Pulley
1563.540	Inlet Valve Assembly
1563.541	Screw Pack - components identified 'A'
1563.543	Cover Assembly Thermostatic
1563.546	Service Tunnel and Insert
1563.549	Component Pack Thermostatic - components identified 'B'
1563.694	Neon Assembly
1563.719	Thermal Switch

Note: in the interests of safety, spares requiring exposure to mains voltage should only be fitted by competent persons.

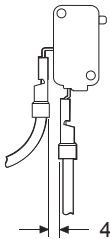
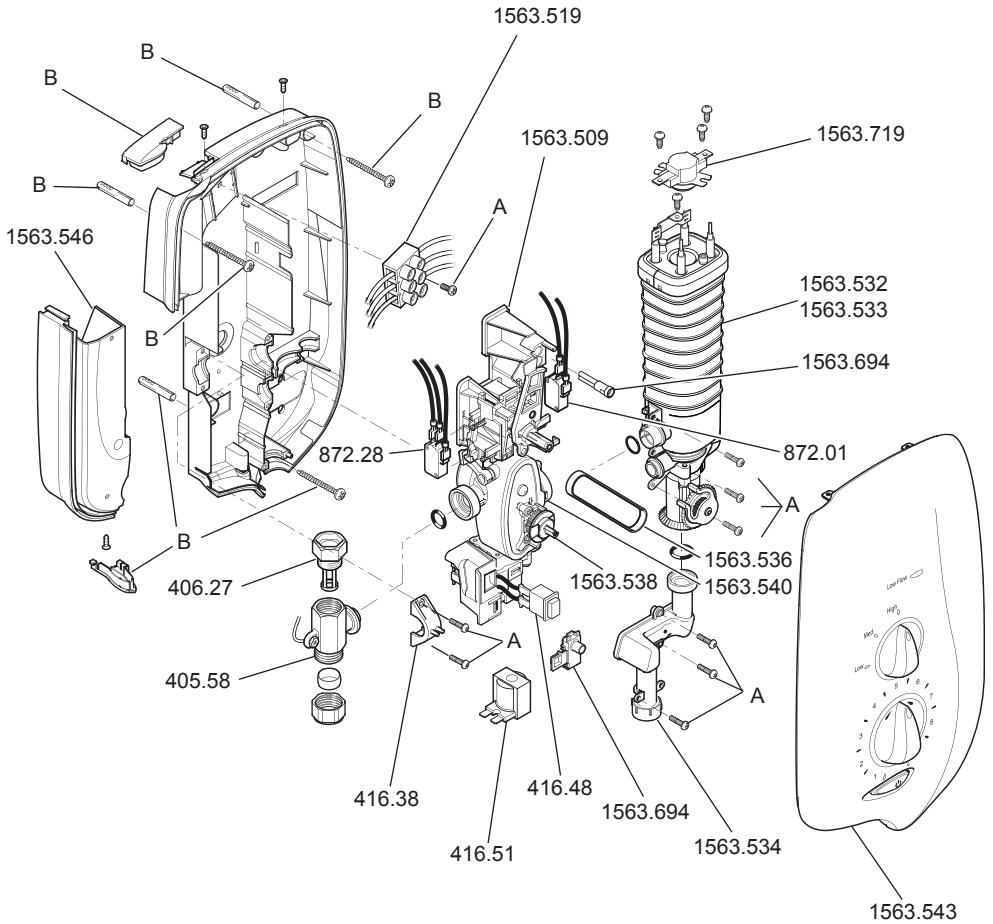

Important! Push-fit connectors must be assembled **back to back** onto terminals of micro-switches.
 A minimum air gap of **4 mm** must be maintained between the connectors after assembly.

4 mm MINIMUM

ACCESSORIES

Genuine Mira accessories can be purchased direct from Customers Services (our contact details can be found on the back cover of this guide) or from approved stockists or merchants.



Everclear Showerhead
White - 2.1616.030
Chrome - 2.1616.031

Mira's new Everclear range has been specially designed for hard water areas and reduces the risk of lime scale build up.

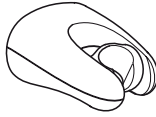

Logic Showerhead Holder
White - 2.1605.149
White/Chrome - 2.1605.150

An alternative to the traditional slide bar. Often a useful addition when positioned for the smaller members of the family.

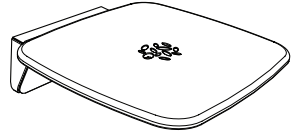

Premium Shower Seat
White/Chrome - 2.1731.001
Grey/Chrome - 2.1731.002

Stylish, slim-line and robust shower seat for use in or outside of the shower area. Folds up when not in use. Maximum User Weight - 150 kg (23.5 stone) **Note!** Must be installed onto a solid wall.



Mira Standard Grab Bars
300 mm - 2.1605.070
450 mm - 2.1605.071
600 mm - 2.1605.072

Premium grade, highly polished, stainless steel grab bars.

Note! Must be installed onto a solid wall.

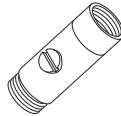

Outlet Double Check Valve (DCV-H)
Chrome - 1.0.110.55.1

An outlet double check valve, designed to prevent the back flow or back-siphonage of potentially contaminated water, through shower controls which are fitted with a flexible shower hose as part of the outlet shower fitting.

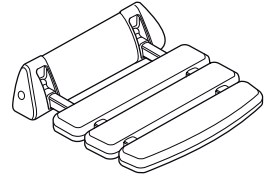

Shower Seat
White - 2.1536.128
White/Chrome - 2.1536.129

For use in or out of the showering area. Folds up when not in use. Maximum User Weight - 127 kg (20 stone) **Note!** Must be installed onto a solid wall.

WIRING DIAGRAM

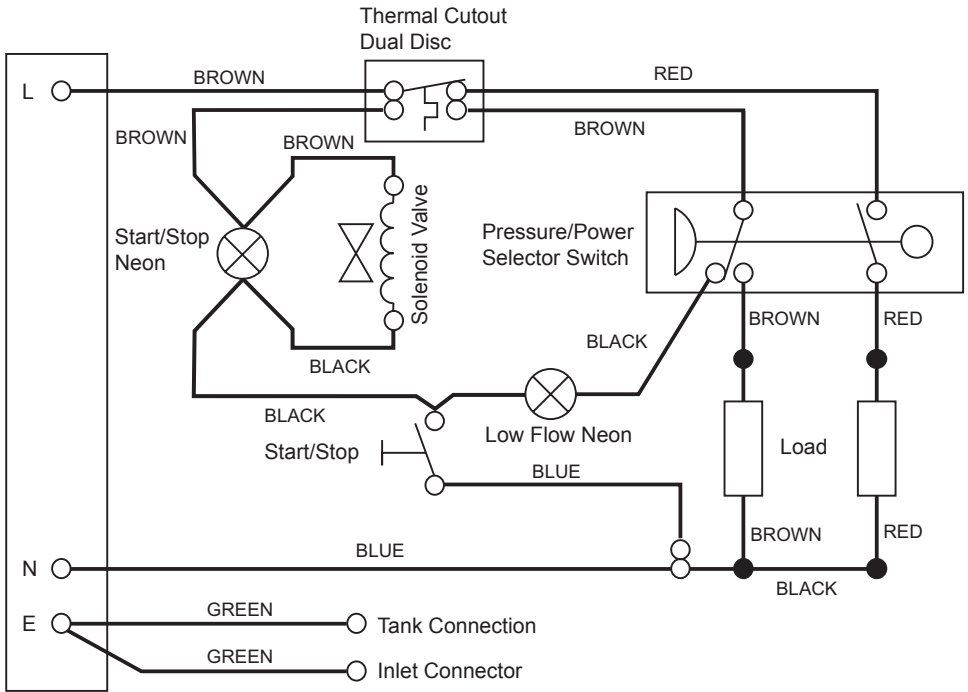

Internal Wiring Diagram

NOTES

NOTES

CUSTOMER SERVICE

Guarantee

Your product has the benefit of our manufacturer's guarantee which starts from the date of purchase.

To activate this guarantee, please return your completed registration card, visit our website or free phone 0800 0731248 within 30 days of purchase (UK only).

Within the guarantee period we will resolve defects in materials or workmanship, free of charge, by repairing or replacing parts or product as we may choose.

If you have not previously activated the guarantee, you will be required to do so prior to the provision of assistance. If you do not activate your guarantee our Engineer will be entitled to charge full payment for the visit (Call out fee plus parts).

This guarantee is in addition to your statutory rights and is subject to the following conditions:

- The product must be installed and maintained in accordance with the instructions given in this user guide.
- Servicing must only be undertaken by us or our appointed representative. **Note!** if a service visit is required the product must be fully installed and connected to services.
- Repair under this guarantee does not extend the original expiry date. The guarantee on any replacement parts or product ends at the original expiry date.
- For shower fittings or consumable items we reserve the right to supply replacement parts only.

The guarantee does not cover:

- Call out charges for non product faults (such as damage or performance issues arising from incorrect installation, improper use, lack of maintenance, build up of limescale, frost damage, corrosion, system debris or blocked filters) or where no fault has been found with the product.
- Water or electrical supply, waste and isolation issues.
- Compensation for loss of use of the product or consequential loss of any kind.
- Damage or defects caused if the product is repaired or modified by persons not authorised by us or our appointed representative.
- Routine maintenance or replacement parts to comply with the requirements of the TMV 2 or TMV 3 healthcare schemes.

What to do if something goes wrong

If your product does not function correctly when you first use it, contact your installer to check that it is installed and commissioned in accordance with the instructions in this manual. Should this not resolve the issue, contact our Customer Services Team who will offer you or your installer advice and if applicable arrange for a Service Technician to call. If the performance of your product declines, check in this manual to see if simple home maintenance is required. If you require further assistance call our Customer Services Team.

Extended Guarantees

A selection of protection plans are available that enable you to cover repair bills for the life of your policy (excludes Eire). Ring 01922 471763 for more details.

Helpdesk Service

Our dedicated Customer Services Team is comprehensively trained and can offer help and advice, spare parts, accessories or a service visit. We will need you to have your model name or number, power rating (if applicable) and date of purchase. As part of our quality and training programme calls may be recorded or monitored.

Mira Showers Website (www.mirashowers.co.uk)

From our website you can register your guarantee, download additional user guides, diagnose faults, purchase our full range of accessories and popular spares, refer to our FAQ's and request a service visit.

Spares and Accessories

We maintain extensive stocks of genuine spares and accessories and aim to provide support throughout the product's expected life. Payment can be made by phone at time of order using most major Credit or Debit cards and we aim to despatch orders within two working days. Items purchased from us are guaranteed for 12 months from date of purchase. For safety reasons spares exposed to mains voltages should only be fitted by competent persons.

Returns – items can be returned within one month of date of purchase, providing that they are in good condition and the packaging is unopened. Please obtain authorisation from our Customer Services Team before return. We reserve the right to apply a 15% restocking charge.

Service / Repairs

We have a nationwide team of Service Technicians who can carry out all service or repair work to your product within the guarantee period and beyond. You have the assurance of a fully trained Mira Technician, genuine Mira spare parts and a 12 month guarantee on any chargeable work done.

Payment should be made directly to the Service Technician who will accept most major Credit or Debit cards.

To Contact Us

UK

Telephone: 0844 571 5000

www.mirashowers.co.uk

E-mail: technical@mirashowers.com

Fax: 01242 282595

By Post: Mira Customer Services Dept, Cromwell Road, Cheltenham, Gloucestershire, GL52 5EP

Eire

Telephone: 01 459 1344

E-mail: sales@modernplant.ie

Fax: Dublin 01 459 2329

By Post: Modern Plant Ltd (Dublin),

Otter House, Naas Road, Clondalkin, Dublin 22

Mira is a registered trade mark of
Kohler Mira Limited.

The company reserves the right to alter
product specifications without notice.



FM 14648

mira

SHOWERS