

Components

Product includes:
1193643 Basin Clamps



ADA CSA B651 OBC

Codes/Standards











ASME A112.19.2/CSA B45.1
All applicable US Federal and State material regulations
ADA
ICC/ANSI A117.1
CSA B651
OBC

KOHLER® One-Year Limited Warranty

See website for detailed warranty information.

Available Color/Finishes

Color tiles intended for reference only.

Color	Code	Description
	0	White
	96	Biscuit
	47	Almond
	NY	Dune
	95	Ice™ Grey
	G9	Sandbar
	33	Mexican Sand™
	K4	Cashmere
	58	Thunder™ Grey
	7	Black Black™

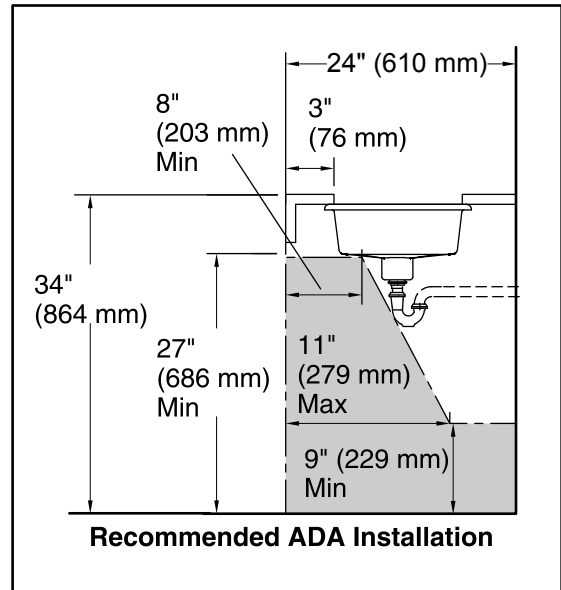
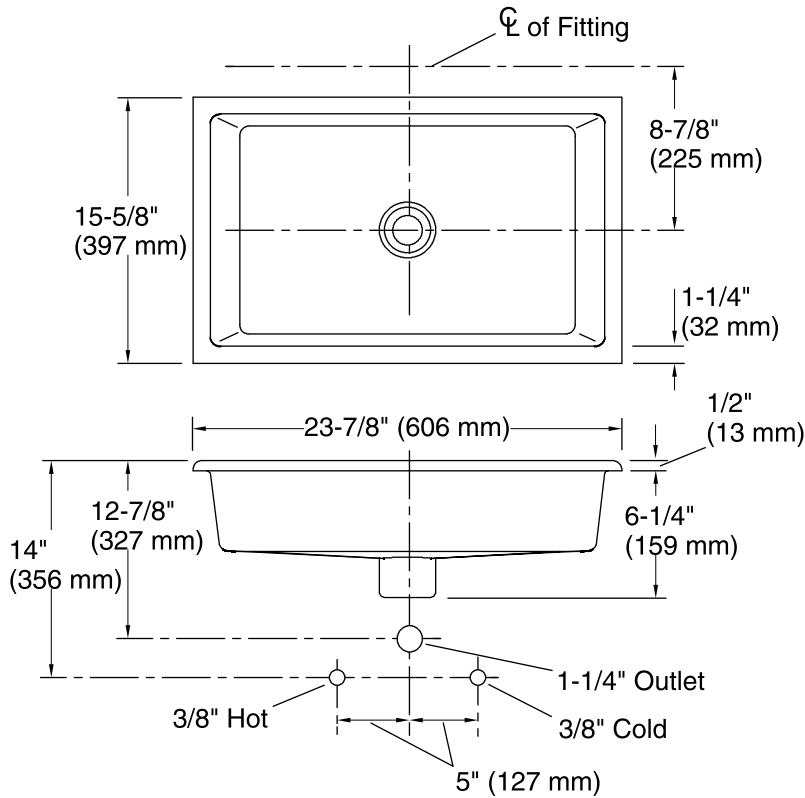

Technical Information

All product dimensions are nominal.

Bowl configuration:	Single
Installation:	Under-mount
Bowl area (Only)	Length: 21-3/8" (543 mm) Width: 13-1/8" (333 mm) Bowl depth: 4-7/8" (123 mm) With overflow: Yes Water depth: 3-5/16" (84 mm)
Bowl area	With overflow: Yes
Drain hole:	1-3/4" (44 mm)
Template:	1241343-7, not required, included

Notes

Install this product according to the installation instructions.

NOTICE: Countertop manufacturer or cutter must use the current product template available at www.kohler.com, or by calling 1-800-4KOHLER. Kohler Co. is not responsible for cutout errors when the incorrect cutout template is used.

Select a faucet with a minimum spout reach of 4-5/8" (117 mm). Refer to the faucet rough-in dimensions to ensure the spout will reach over the bathroom sink rim into the basin.

ADA, OBC, CSA B651 compliant when installed to the specific requirements of these regulations.