



# KOHLER®

## Toilets Service Parts

March 2015



GENUINE PARTS  
**STERLING**  
A KOHLER COMPANY

**KOHLER**  
GENUINE PARTS



# KOHLER® Toilets Service Parts

## Tips to Finding the Right Part

### Check if Your Toilet Is a One-Piece or Two-Piece Toilet



One-piece toilets integrate tank and bowl into a seamless design.



Two-piece toilets feature the traditional design of a separate tank and bowl.

### Determine Your Toilet's Flushing Technology

All KOHLER flushing technologies are described, along with their common replacement parts, on pages 4-11. To determine your toilet's flushing technology, look inside the tank and compare your flushing technology with those pictured in this catalog.

### Look for Model and Service Information

If you have a toilet manufactured:

After 1990, service information is imprinted on the underside of tank lid.



The toilet number is imprinted on the inside back of the tank.

### Find Your Toilet in the Matrix

If you do not find the part you need pictured on pages 4-11, use the information you have gathered to find your toilet in the corresponding section of the matrix. The replacement part numbers for the float/fill valve, flush valve, tank gasket and flush ball/flapper are listed for each toilet. To view all the service parts for your toilet, visit [KOHLER.com/serviceparts](http://KOHLER.com/serviceparts) for the expanded service parts pages.

## Toilets – Flushing Technologies ..... 4-11

## Toilets – Detailed Parts Matrix

Canister (Single-Fush) One-Piece Toilets ..... 14-17

Canister (Single-Fush) Two-Piece Toilets..... 18-21

Canister (Dual-Flush) One- and Two-Piece Toilets..... 22-25

Touchless Flush Toilets ..... 26-27

2-Inch Flapper One-Piece Toilets ..... 28-37

2-Inch Flapper Two-Piece Toilets ..... 38-47

3¼-Inch Flapper One- and Two-Piece Toilets ..... 48-51

Numi®/Power Lite® One-Piece Toilets..... 52-53

Pressure Lite® One- and Two-Piece Toilets ..... 54-55

STERLING® Toilets ..... 56-59

## Power Lite® One-Piece Toilets

**POWER LITE®**  
KOHLER®

If you have a Power Lite toilet, there will be an electrical cord extending from the toilet to a power outlet.



Power Lite toilets have specific replacement parts for each model.

See pages 52-53 for parts related to Power Lite toilets.

For detailed parts listings, see pages 52-53.

---

## Pressure Lite® One- and Two-Piece Toilets

**PRESSURE LITE®**  
KOHLER®

If you have a Pressure Lite toilet, you will see a holding vessel within the tank.



Pressure Lite toilets have specific replacement parts for each model.

See pages 54-55 for parts related to Pressure Lite toilets.

For detailed parts listings, see pages 54-55.

# Canister (Single-Flush) Toilets

CLASS SIX<sup>®</sup>  
KOHLER<sup>®</sup>

CLASS FIVE<sup>®</sup>  
KOHLER<sup>®</sup>

If you have a single-flush canister toilet, you will not see a flapper in the tank but a cylinder-shaped flush valve. These toilets do not use a flapper, but a seal. ***If your toilet is leaking water into the bowl, the seal needs to be replaced, not the canister.***

**AquaPiston<sup>®</sup>**  
\*AquaPiston canister allows water to flow into the bowl from all sides (360 degrees), increasing the power and effectiveness of the flush.



Guide Kit  
(Includes center guide,  
cap and chain)  
GP1229656



**YOUR CAP COLOR  
DOES NOT MATTER.**

-Match stem color and insert size

-If stem is grey with small insert,  
use GP1138930.



GP1138930  
GP1060294M (Mexico)

-If stem is black with large insert,  
use GP1083167.



GP1083167  
GP1060299M (Mexico)

\*Must use proper valve for  
optimal performance.

Proprietary  
Formulated Yellow  
Seal  
GP1059291



Replaces Red Seal



Two-piece canister toilets  
will have triangle gasket kit  
GP51487



or DryLock<sup>™</sup> gaskets.

GP1018165-F  
(3" gasket)



1024390  
(bolts)



GP1112256  
(2" gasket)



1024390  
(bolts)



# Canister (Dual-Flush) Toilets

DUAL FLUSH  
KOHLER.

If you have a dual-flush toilet, you will see a two-button actuator on the top or a two-part trip lever on the side, rather than a standard trip lever. Inside the tank you will not see a flapper but a cylinder-shaped flush valve. These toilets do not use a flapper, but a seal. ***If your toilet is leaking water into the bowl, the seal needs to be replaced, not the canister.***

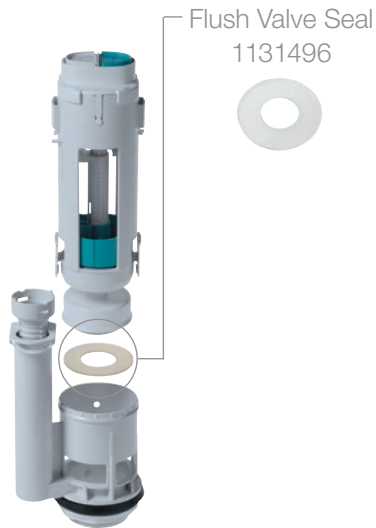

YOUR CAP COLOR  
DOES NOT MATTER.

Use GP1138930



The innovative dual-tone trip lever features two flush options. The longer green lever provides a light 1.1 gallon flush; the full lever provides a full 1.6 gallon flush.



YOUR CAP COLOR  
DOES NOT MATTER.

Use GP1138930



# Touchless Flush Toilets



The KOHLER touchless toilet is the no-touch flush. Just hold your hand over the tank sensor to activate the flush. No handle to touch means fewer germs to pick up or leave behind.

Guide Kit  
(Includes center guide,  
cap and chain)  
GP1229656



Proprietary  
Formulated Yellow  
Seal  
GP1059291



Touchless Unit



## YOUR CAP COLOR DOES NOT MATTER.

-Match stem color and insert size

-If stem is grey with small insert,  
use GP1138930.



GP1138930  
GP1060294M (Mexico)

-If stem is black with large insert,  
use GP1083167.



GP1083167  
GP1060299M (Mexico)

\*Must use proper valve for  
optimal performance.

## Touchless Conversion Kit

### K-1954

Upgrade your toilet to a no-touch flush. This easy-to-install retrofit kit brings a KOHLER touchless flush to almost any toilet. Once it's installed, just hold your hand over the tank sensor to activate the flush. No handle to touch means fewer germs to pick up or leave behind.



Visit [www.us.kohler.com](http://www.us.kohler.com) to see if your toilet is compatible.

# 2-Inch Flapper One-Piece Toilets

Toilets manufactured prior to 2004 most commonly have a 2-inch flapper.



**YOUR CAP COLOR  
DOES NOT MATTER.**

Use GP1138930  
GP1060294M (Mexico)



For your toilet  
See pages 28-37



Must use proper valve for  
optimal performance.

## Flappers

**GP84995** – Used in various one-piece toilets



Replaces flapper with  
rubber bar



**GP83064** – Used in older one-piece toilets



**GP1078440** – Used in various one-piece toilets



Replaces discontinued  
flappers 88925, 85655,  
84138, 84314

**GP89825** –  
For Portrait<sup>®</sup> toilets



**GP88921** – Used in older one-piece toilets

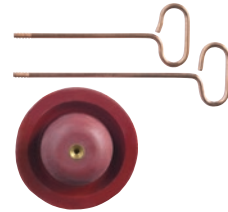



# 2-Inch Flapper Two-Piece Toilets

Toilets manufactured prior to 2004 most commonly have a 2-inch flapper. All two-piece toilets that have a 2-inch flapper use fill valve GP1138930.



**YOUR CAP COLOR DOES NOT MATTER.**

Use GP1138930  
GP106094M (Mexico)



Must use proper valve for optimal performance.

Most two-piece flapper toilets will have:

Tank Gasket GP51487



## Flappers

**GP87449** – Used in various two-piece toilets

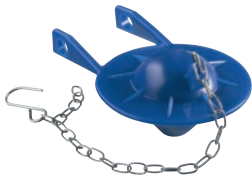

Replaces these discontinued flappers



**GP85160** – Used in various two-piece toilets



Replaces these discontinued flappers



**GP49114** – Used in older two-piece toilets

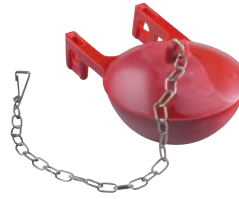

Older toilets may have a black flapper; replace with GP49114.

# 3¼-Inch Flapper One-Piece Toilets

CLASS FIVE<sup>®</sup>  
KOHLER

Toilets that have a 3¼-inch flapper are Class Five<sup>®</sup> toilets.  
All Class Five toilets use fill valve GP1083167.



**YOUR CAP COLOR  
DOES NOT MATTER.**

Fill valve  
GP1083167  
GP10060299 (Mexico)



Must use this valve for  
optimal performance.

## Flappers

**GP1039444** – Cimarron<sup>®</sup> and Memoirs<sup>®</sup>  
one-piece toilets with 3¼" flapper



**GP1067183** – Gabrielle™ one-piece toilet  
with 3¼" flapper



**GP1060740** – Portrait<sup>®</sup> one-piece toilet  
with 3¼" flapper



# 3¼-Inch Flapper Two-Piece Toilets

CLASS FIVE<sup>®</sup>  
KOHLER

Toilets that have a 3¼-inch flapper are Class Five<sup>®</sup> toilets. All Class Five toilets use fill valve GP1083167.



## Flapper

GP1078441 – Used in various two-piece toilets with Class Five technology



YOUR CAP COLOR  
DOES NOT MATTER.

Fill valve  
GP1083167  
GP1083167 (Mexico)



Must use this valve for optimal performance.

DryLock™ system gasket

GP1018165-F  
(3" gasket)



1024390  
(bolts)



# INDEX

## KOHLER® Toilet (Model) Numbers

K-10491.....	16	K-14338.....	24	K-3440.....	38	K-3506.....	48
K-10492.....	16	K-14343.....	48	K-3441.....	44	K-3509 (Canister) .....	20
K-10493.....	20	K-14344.....	48	K-3444.....	42	K-3509 (Flapper) .....	50
K-10494.....	20	K-14345 (Canister) .....	14	K-3445.....	40	K-3510.....	46
K-10495.....	18	K-14345 (Flapper) .....	48	K-3446.....	44	K-3511 (Canister) .....	20
K-11450.....	44	K-14346 (Canister) .....	14	K-3447.....	40	K-3511 (Flapper) .....	50
K-11451.....	18	K-14346 (Flapper) .....	48	K-3448.....	40	K-3512.....	46
K-11452.....	18	K-14509.....	18	K-3449.....	40	K-3513.....	48
K-11453.....	18	K-14797.....	20	K-3450.....	38	K-3514.....	46
K-11456.....	18	K-14799.....	20	K-3451 (2" Flapper) .....	30	K-3515 (Canister) .....	20
K-11460 (Canister) .....	20	K-14824.....	18	K-3451 (3¼" Flapper) ....	48	K-3515 (Flapper) .....	50
K-11460 (Flapper) .....	50	K-15410.....	18	K-3452.....	42	K-3517.....	18
K-11461 (Canister) .....	20	K-3322.....	28	K-3453 (2" Flapper) .....	30	K-3519.....	54
K-11461 (Flapper) .....	50	K-3323.....	36	K-3453 (3¼" Flapper) ....	48	K-3520.....	44
K-11465.....	48	K-3324.....	28	K-3454.....	40	K-3521.....	44
K-11470.....	44	K-3357.....	32	K-3455.....	42	K-3524.....	52
K-11471.....	20	K-3360.....	32	K-3456.....	40	K-3526 (Canister) .....	20
K-11473.....	20	K-3378.....	30	K-3457.....	40	K-3526 (Flapper) .....	50
K-11492.....	20	K-3379.....	52	K-3458.....	54	K-3527.....	44
K-11497.....	20	K-3383.....	30	K-3461.....	42	K-3530.....	38
K-11498.....	20	K-3384.....	36	K-3462.....	42	K-3531.....	54
K-11499.....	20	K-3385.....	34	K-3463.....	40	K-3532 (Canister) .....	20
K-11813.....	18	K-3386.....	32	K-3464.....	42	K-3532 (Flapper) .....	50
K-11821.....	20	K-3390.....	28	K-3465.....	42	K-3533 (Canister) .....	20
K-11823.....	18	K-3393.....	52, 54	K-3466.....	36	K-3533 (Flapper) .....	50
K-11844.....	18	K-3394.....	54	K-3467.....	36	K-3535.....	38
K-11889.....	48	K-3395.....	36	K-3468.....	42	K-3536.....	38
K-11899.....	36	K-3397.....	36	K-3470.....	38	K-3542 (Canister) .....	20
K-11968.....	20	K-3398.....	52	K-3471.....	38	K-3542 (Flapper) .....	50
K-12697.....	18	K-3400.....	30	K-3472.....	38	K-3544.....	54
K-12698.....	18	K-3401.....	28	K-3475.....	38	K-3546.....	54
K-12767.....	18	K-3402.....	32	K-3477.....	38	K-3548 (Canister) .....	20
K-14076.....	44	K-3404.....	54	K-3478.....	38	K-3548 (Flapper) .....	50
K-14110.....	38	K-3405.....	30	K-3479.....	38	K-3551.....	18
K-14128.....	38	K-3406.....	34	K-3480.....	38	K-3554.....	54
K-14133.....	44	K-3407.....	44	K-3481.....	44	K-3555.....	42
K-14143.....	44	K-3408.....	28	K-3482.....	42	K-3556.....	38
K-14150.....	38	K-3410.....	42	K-3483.....	42	K-3557.....	38
K-14178.....	42	K-3411.....	42	K-3484.....	40	K-3564.....	24
K-14210.....	44	K-3412.....	42	K-3485.....	42	K-3574.....	20
K-14213.....	38	K-3414.....	44	K-3486.....	42	K-3575.....	20
K-14230.....	32	K-3415.....	44	K-3487.....	48	K-3576.....	20
K-14231.....	20	K-3417.....	40	K-3488.....	28	K-3577.....	20
K-14233.....	20	K-3419.....	40	K-3489.....	48	K-3588.....	22
K-14239.....	42	K-3420.....	44	K-3490.....	42	K-3589.....	18
K-14247.....	42	K-3421.....	44	K-3491.....	42	K-3591.....	42
K-14250.....	38	K-3422.....	44	K-3492.....	52	K-3597.....	54
K-14257.....	28	K-3423.....	44	K-3493.....	54	K-3598.....	24
K-14258.....	28	K-3427.....	44	K-3496 (Canister) .....	18	K-3600.....	30
K-14261.....	32	K-3428.....	44	K-3496 (Flapper) .....	48	K-3607.....	52, 54
K-14268.....	28	K-3429.....	42	K-3497 (Canister) .....	18	K-3608.....	48
K-14286.....	28	K-3432.....	44	K-3497 (Flapper) .....	48	K-3609.....	18
K-14289.....	34	K-3433.....	44	K-3499.....	48	K-3611.....	20
K-14290.....	34	K-3434.....	32	K-3500.....	46	K-3612.....	32
K-14291.....	34	K-3435.....	34	K-3502.....	46	K-3615.....	14
		K-3437.....	52	K-3503.....	48	K-3619.....	14
		K-3438.....	44	K-3504.....	46	K-3639.....	14
		K-3439.....	42	K-3505.....	54	K-3648.....	20

K-3651.....	42
K-3652.....	54
K-3654.....	22
K-3655.....	28
K-3667.....	20
K-3668.....	20
K-3669.....	20
K-3670.....	28
K-3678.....	18
K-3713.....	20
K-3722.....	16
K-3723.....	22
K-3753.....	22
K-3754.....	18
K-3755.....	18
K-3797.....	24
K-3802.....	48
K-3803.....	36
K-3804.....	32
K-3810.....	16
K-3811.....	16
K-3812.....	14
K-3813.....	14
K-3816.....	20
K-3817.....	20
K-3818.....	20
K-3819.....	20
K-3825.....	14
K-3827.....	18
K-3828.....	14
K-3837.....	18
K-3851.....	18
K-3887.....	18
K-3888.....	18
K-3889.....	20
K-3933.....	20
K-3900.....	52
K-3901.....	52
K-3940.....	14
K-3946.....	14
K-3947.....	20
K-3948.....	20
K-3949.....	20
K-3950.....	20
K-3977.....	20
K-3978.....	20
K-3979.....	20
K-3981.....	16
K-3986.....	20
K-3987.....	24
K-3988.....	24
K-3989.....	24
K-3997.....	20
K-3998.....	20
K-3999.....	20
K-4000.....	13
K-4007.....	16
K-402209.....	56

K-402211.....	56
K-402212.....	56
K-402213.....	56
K-45979.....	22
K-45989.....	22
K-5172.....	16
K-5692.....	26
K-5693.....	26
K-6303.....	24
K-6418.....	26
K-6419.....	26
K-6424.....	16
K-6428.....	16
K-6669.....	20
K-6925.....	14
K-6999.....	20
K-98864.....	22
K-98976.....	18
K-98977.....	18
K-98992.....	18
K-98993.....	16
K-98994.....	20

**KOHLER®  
(Tank Only) Numbers**

K-14078.....	44
K-14108.....	38
K-14129.....	38
K-14137.....	44
K-14147.....	44
K-14154.....	38
K-14179.....	42
K-14212.....	44
K-14215.....	38
K-14233.....	20
K-14241.....	42
K-14249.....	42
K-14252.....	25
K-3613.....	42
K-402092.....	56
K-402093.....	56
K-4136.....	22
K-4137.....	22
K-4166.....	18
K-4167.....	18
K-4209.....	44
K-4383.....	18
K-4401.....	40
K-4403.....	40
K-4418.....	18
K-4419.....	22
K-4421.....	18
K-4431.....	18
K-4433.....	20
K-4434.....	20
K-4436.....	20
K-4437.....	20
K-4438.....	18

K-4441.....	22
K-4442.....	22
K-4445.....	42
K-4446.....	18
K-4447.....	40
K-4454.....	42
K-4456.....	38
K-4458.....	24
K-4464.....	42
K-4467.....	20
K-4468.....	20
K-4469.....	18
K-4470.....	54
K-4472.....	22
K-4473 (Canister).....	20
K-4473 (Flapper).....	50
K-4474.....	18
K-4484.....	54
K-4485 (Canister).....	20
K-4485 (Flapper).....	50
K-4491 (Flapper).....	50
K-4492 (Flapper).....	50
K-4493.....	18
K-4501.....	38
K-4504.....	44
K-4505.....	38
K-4509.....	38, 46
K-4512.....	44
K-4515.....	42
K-4516.....	42
K-4518.....	44
K-4519.....	44
K-4524.....	46
K-4586.....	40
K-4590.....	42
K-4591.....	38
K-4597.....	44
K-4605.....	38
K-4606.....	40
K-4608.....	42
K-4609.....	42
K-4619.....	40
K-4620.....	44
K-4621.....	44
K-4628.....	42
K-4632.....	20
K-4633.....	48
K-4634 (Canister).....	18
K-4634 (Flapper).....	48
K-4641.....	20
K-4642.....	20
K-4645.....	54
K-4646.....	31
K-4708.....	48
K-4742.....	24
K-4807.....	42
K-4835.....	18
K-4841.....	20

K-4899.....	20
K-5380.....	18
K-6284.....	20

**STERLING® Toilets  
(Tank Only) Numbers**







402014.....	58
402015.....	58
402020.....	50
402024.....	56
402025.....	56
402027.....	56
402028.....	56
402075.....	56
402076.....	56
402077.....	56
402078.....	58
402079.....	58
402080.....	58
402081.....	58
402082.....	58
402083.....	56
402084.....	56
402085.....	56
402087.....	56
402088.....	56
402214.....	58
402215.....	58
402220.....	56
402315.....	58
402375.....	56
402502.....	56
402522.....	56
402532.....	56
403080.....	58
403081.....	58
403082.....	58
404700.....	58
404701.....	56
404702.....	56
404705.....	58
402022.....	56
402023.....	56
402071.....	56
402091.....	56
404514.....	58
404515.....	58
404520.....	56
404544.....	58
404551.....	58
404552.....	56
404555.....	58

# Canister (Single-Flush) One-Piece Toilets

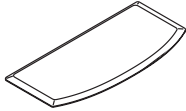
## Toilet

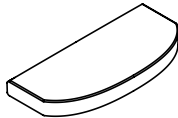

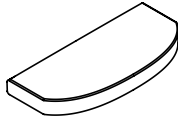
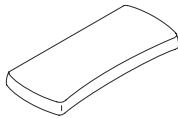
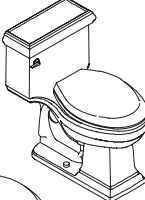
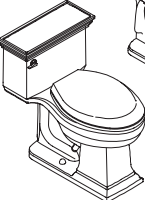
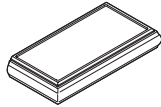
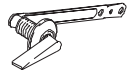









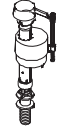

## Toilet Details

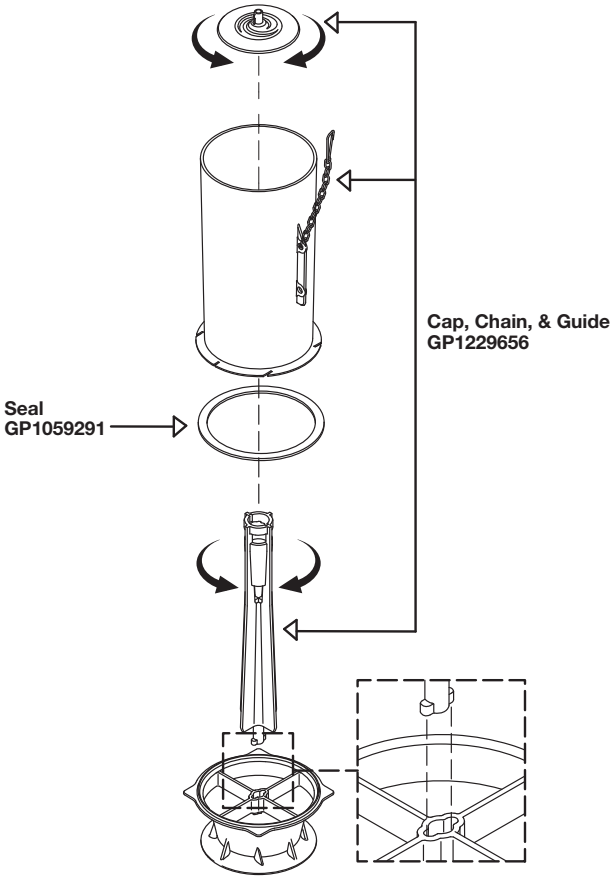
Canister  
(Single-Flush) Toilets

Product Name	Model Number	Tank Cover	Trip Lever
Adair® 	K-3946 K-6925	1180586* 	1034693* LH 1036058* RH 
Archer® 	K-3639	1046467* 	1067577* 
Cimarron® 	K-3828	1036367* 	1034693* LH 1036058* RH 
Cimarron Skirted 	K-3619	1036367* 	1034693* LH 1036058* RH 
Gabrielle™ 	K-3615 K-3825  Artist Editions®: K-14345, K-14346	85407* 	1025329* LH 1025330* RH  1068627* LH 1080378* RH 
Kathryn® 	K-3940	1006066* 	1211496* 
Memoirs® Classic   Memoirs Stately	K-3812 (Classic) K-3813 (Stately)	88871* Classic   88872* Stately 	1160316* LH   1160317* RH 

**Canister (Single-Flush) One-Piece Toilets**  
**KOHLER® Genuine Parts**

**Canister**  
**(Single-Flush) Toilets**

Float/Fill Valve	Chain/Guide/Seal	Canister	Tank Gasket
GP1083167 		1218038 (K-3946) 1193491 (K-6925)	GP83996 
GP1083167 	<p><b>NOTE: The canister should not fail. If leaking occurs, replace seal GP1059291.</b></p>	1216616	GP83996 
GP1060299M (Mexico Only)			
GP1083167 		1216624	GP83996 
GP1060299M (Mexico Only)			
GP1083167 		1255785	GP83996 
GP1083167 		1216611	GP83996 
GP1083167 		1211498	GP83996 
GP1083167 	<p><b>** If tabs on guide or cap break, Replace with Kit GP1229656</b></p>	1216612	GP83996 







Note: Part numbers that have a "GP" prefix refer to a blister package. For example, GP1059291 is the same part as previous part number 1059291 but in a blister package.

# Canister (Single-Flush) One-Piece Toilets

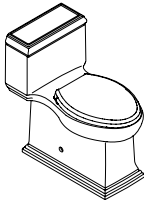
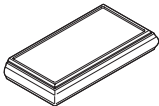
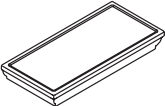
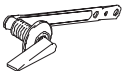
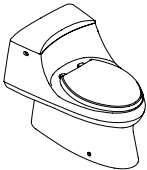
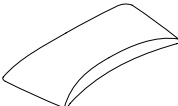
## Toilet

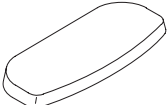
## Toilet Details

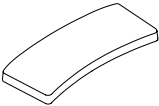

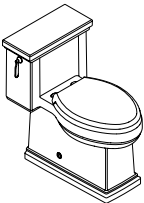
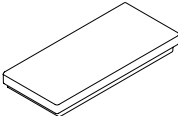
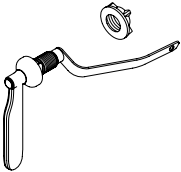





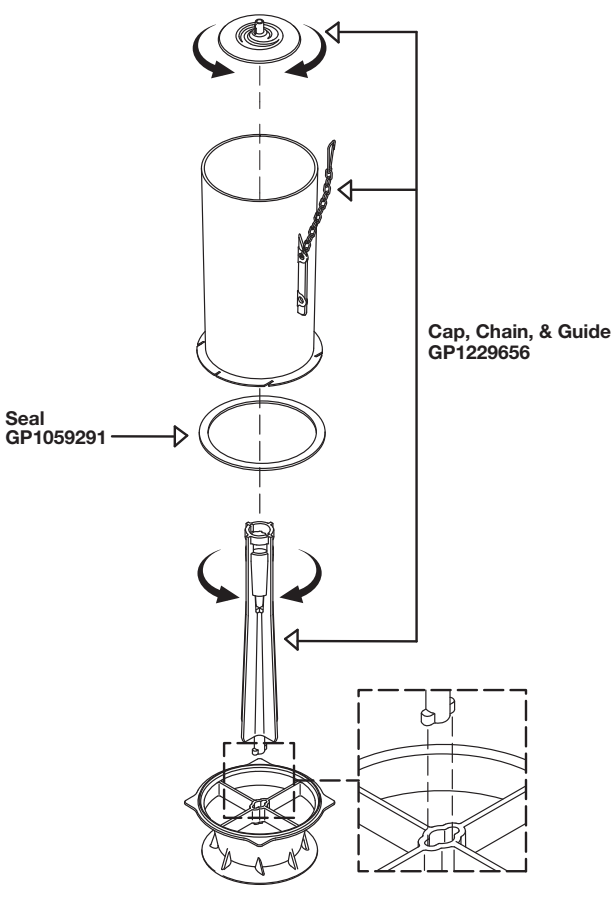

Canister  
(Single-Flush) Toilets

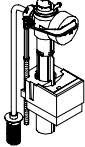
Product Name	Model Number	Tank Cover	Trip Lever
Memoirs <sup>®</sup> Skirted 	K-6424 (Classic) K-6428 (Stately)	1220279* Classic  1220280* Stately 	1160316* LH 
San Raphael <sup>®</sup> 	K-3722	1126374* 	1128497* 
Santa Rosa <sup>™</sup> 	<b>1.28 GPF</b> <b>1.6 GPF</b> K-3810        K-3811 K-10491      K-10492 K-98993	88497* 	1158701* LH 1245886* RH 
San Souci <sup>®</sup> 	K-5172 (Elongated) K-4007 (Round-Front)	1182368* (Elongated)  1242241* (Round-Front)	1238613* LH (Elongated) 1241200* RH (Elongated)  1241416* LH (Round-Front)
Tresham <sup>®</sup> 	K-3981	1223375* 	1161319* 

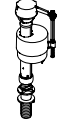

**Canister (Single-Flush) One-Piece Toilets**  
**KOHLER® Genuine Parts**

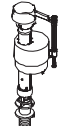
**Canister**  
**(Single-Flush) Toilets**

Float/Fill Valve	Chain/Guide/Seal	Canister	Tank Gasket
<p>GP1138930</p> 	<p><b>NOTE: The canister should not fail. If leaking occurs, replace seal GP1059291.</b></p>  <p align="center"><b>Cap, Chain, &amp; Guide</b> <b>GP1229656</b></p> <p><b>Seal</b> <b>GP1059291</b></p> <p><b>** If tabs on guide or cap break, Replace with Kit GP1229656</b></p>	<p>1244399</p>	<p>GP83996</p> 
<p>1128657</p> 		<p>Canister 1238986</p> <p>Flapper 1138648</p> 	<p>GP83996</p> 
<p>GP1083167</p>  <p>GP1060299M (Mexico Only)</p>		<p><b>1.6 GPF</b> 1216619</p> <p><b>1.28 GPF</b> 1216612 1216625 (Mexico)</p>	<p>GP83996</p> 
<p>1237539 (Elongated)</p> 		<p>1237538 (Elongated) 1227235 (Round-Front)</p>	<p>GP83996</p> 
<p>1241415 (Round)</p> 		<p>1244399</p>	<p>GP83996</p> 











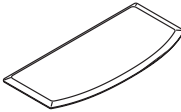





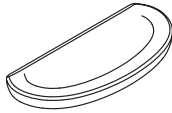

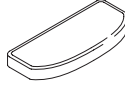

Note: Part numbers that have a "GP" prefix refer to a blister package. For example, GP1059291 is the same part as previous part number 1059291 but in a blister package.

# Canister (Single-Flush) Two-Piece Toilets

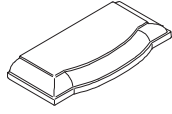
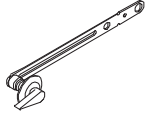
## Toilet

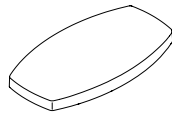
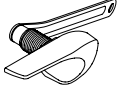
## Toilet Details

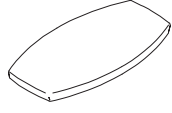









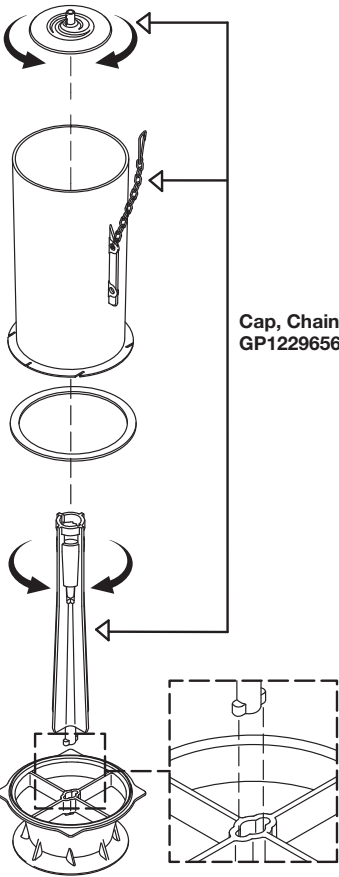





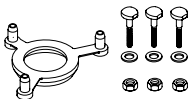

Canister  
(Single-Flush) Toilets

Product Name	Model Number	Tank Cover	Trip Lever
Archer <sup>®</sup> 	<b>1.28 GPF</b> K-3551 K-10495 Tank: K-4431	<b>1.6 GPF</b> K-3517 Tank: K-4493	1046467*  1067577* 
Bancroft <sup>®</sup> 	K-3827 Tank: K-4383	1033723* 	1042212* 
CLASS FIVE <sup>™</sup> Cavata <sup>®</sup> 	K-12697 K-12698 Tank: K-4835	1145294* 	1154764* 
Cimarron <sup>®</sup> 	<b>Elongated Bowl</b>		1086929*  1034693* LH 1116014* RH 
	<b>1.28 GPF</b> K-3609, K-11451, K-11813, K-98977 Tank: K-4421		
	<b>1.6 GPF</b> K-3589, K-11456, K-11823 Tank: K-4418		
	<b>Round-Front Bowl</b>		
CLASS FIVE <sup>™</sup>	<b>1.6 GPF</b> K-3888 Tank: K-4167		1015867*  1034693* LH 1036058* RH 
	<b>Round-Front Bowl</b>		
	<b>1.28 GPF</b> K-3851, K-3887, K-14509, K-15410, K-98976 Tank: K-4166		
* Parts for Touchless Version on page 26	<b>1.28 GPF</b> K-3496-HE Tank: K-4634-HE	<b>1.6 GPF</b> K-3678 Tank: K-4446	1034693* LH 1036058* RH 
Devonshire <sup>®</sup> 	<b>1.28 GPF</b> K-3837 Tank: K-4438 K-14824, K-98992	<b>1.6 GPF</b> K-3678 Tank: K-4446	1044820*  1126917* LH 1160317* RH 
Elliston <sup>®</sup> 	K-12767 Tank: K-5380	1211811* 	1213839* 
Kelston <sup>®</sup> 	<b>1.28 GPF</b> K-11453, K-11844, K-3755 Tank: K-4469	<b>1.6 GPF</b> K-3754 K-11452 Tank: K-4474	1070414*  1075394* 

# Canister (Single-Flush) Two-Piece Toilets

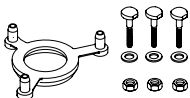
## KOHLER® Genuine Parts

Canister  
(Single-Flush) Toilets

Float/Fill Valve	Chain/Guide/Seal	Canister	Tank Gasket
GP1083167  GP1060299M (Mexico Only)	<div style="text-align: center;">  <p><b>NOTE: The canister should not fail. If leaking occurs, replace seal GP1059291.</b></p> <p><b>Cap, Chain, &amp; Guide GP1229656</b></p> <p><b>Seal GP1059291</b></p> <p><b>** If tabs on guide or cap break, Replace with Kit GP1229656</b></p> </div>	<b>1.28 GPF</b> 1216613 1216621 (Mexico)	GP1018165-A (1.6 GPF) GP1018165-F (1.28 GPF)  3" 1024390 
GP1083167  GP1060299M (Mexico Only)		<b>1.28 GPF</b> 1216614	GP51487 
GP1083167 		<b>1.28 GPF</b> 1161447	GP51487 
GP1083167  GP1060299M (Mexico Only)		<b>1.28 GPF</b> <b>1.6 GPF</b> 1188999    1188998 1190386    1216616 (Lined Tank)	GP1112256  2" 1024390 
 GP1138930		<b>1.6 GPF</b> 1189001	GP1112256  2" 1024390 
GP1083167  GP1060299M (Mexico Only)		<b>1.28 GPF</b> 1189000 1191371	<b>1.28 GPF</b> <b>1.6 GPF</b> 1113628    1083980 1142634 (Lined Tank)
GP1083167 		<b>1.28 GPF</b> 1216615 <b>1.6 GPF</b> 1216609	GP51487 
GP1083167  GP1060299M (Mexico Only)		<b>1.28 GPF</b> 1216610 <b>1.6 GPF</b> 1216609	GP1018165-F  3" 1024390  GP1018165-F  3"











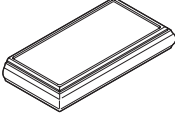



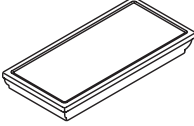

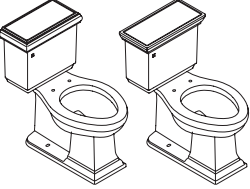
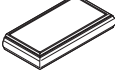
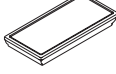



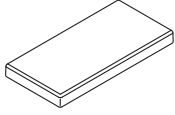

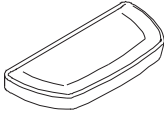
Note: Part numbers that have a "GP" prefix refer to a blister package. For example, GP1059291 is the same part as previous part number 1059291 but in a blister package.

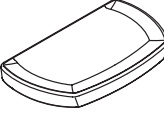
# Canister (Single-Flush) Two-Piece Toilets

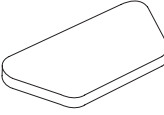
## Toilet

## Toilet Details

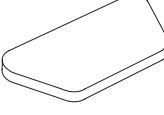









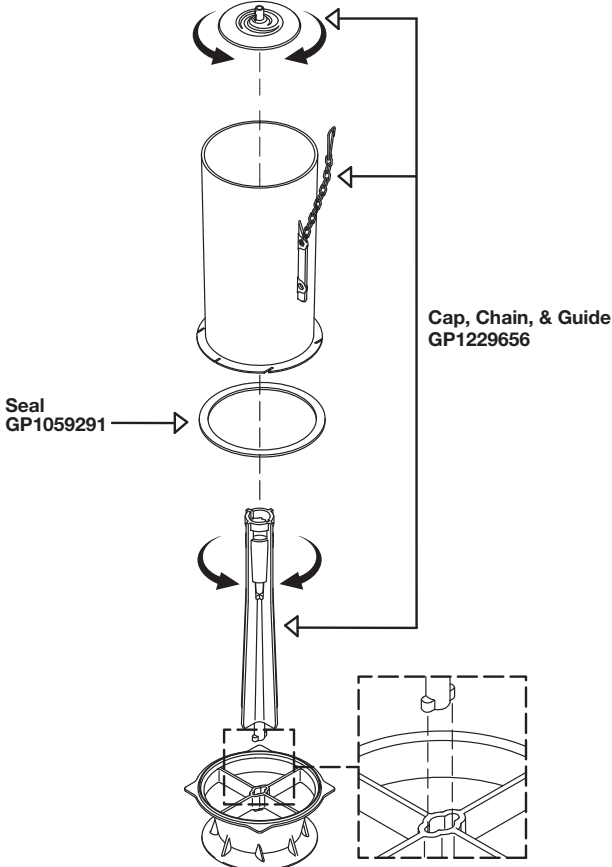

### Canister (Single-Flush) Toilets

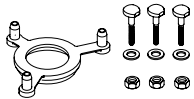
Product Name	Model Number	Tank Cover	Trip Lever
<b>Memoirs® Classic</b>  <b>CLASS FIVE.</b> <small>KOHLER</small>	<b>1.28 GPF</b> K-3986, K-3816, K-10493, Tank: K-4485 K-3532, K-3542 Tank: K-4433  <b>Artist Editions®:</b> K-14231 Tank: K-14233	<b>1.6 GPF</b> K-11461, K-3509, K-3515, K-3818 Tank: K-4641	1052861* Classic  1160316* LH 1160317* RH  
<b>Memoirs Stately</b>  <b>CLASS FIVE.</b> <small>KOHLER</small>	<b>1.28 GPF</b> K-3933, K-3817, K-10494, K-98994 Tank: K-4434	<b>1.6 GPF</b> K-3511, K-3526, K-3819, K-11460 Tank: K-4642 K-3533, K-3548, K-11968 Tank: K-4473	1052862* Stately  1160316* LH 1160317* RH  
<b>Memoirs Concealed Bowl</b> 	<b>Stately</b> K-6669 Tank: K-4434  <b>Classic</b> K-6999 Tank: K-4433	1052861* Classic  1052862* Stately 	1160316* LH 1160317* RH  
<b>Tresham®</b> 	K-3950 Tank: K-4899	1146775* 	1161319* 
<b>Wellworth®, Highline®</b> 	<b>1.28 GPF</b> K-3997, K-3998, K-3999, K-3889 Tank: K-4467  <b>1.6 GPF</b> K-3977, K-3978, K-3979 Tank: K-4468	1138565* 	1142713* 
<b>Wellworth, Highline</b> 	K-3947, K-3948, K-3949 Tank: K-4841	1145223* 	1142713* 
<b>Wellworth, Highline Classic</b>  <b>CLASS FIVE.</b> <small>KOHLER</small>	<b>1.28 GPF</b> K-3648, K-3713 Tank: K-4436  <b>1.6 GPF</b> K-11821, K-11471, K-11473, K-11492, K-3574, K-3576, K-3611 Tank: K-4632	84591* 84095* (14" Tank) 	1133133* RH (Metal Arm)  1117207* LH (Metal Arm) 1069723* LH (Plastic Arm) 
<b>Wellworth® Classic</b>  <b>CLASS FIVE.</b> <small>KOHLER</small>	<b>1.28 GPF</b> K-3575, K-3577, K-11497, K-11498, K-11499, K-14797, K-14799 Tank: K-4436  <b>1.6 GPF</b> K-3667, K-3668, K-3669 Tank: K-4437	84591* 84095* (14" Tank) 	1133133* RH (Metal Arm)  1117207* LH (Metal Arm) 

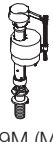
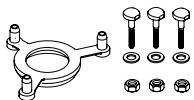
# Canister (Single-Flush) Two-Piece Toilets

## KOHLER® Genuine Parts

Canister  
(Single-Flush) Toilets

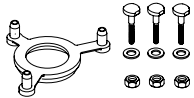
Float/Fill Valve	Chain/Guide/Seal	Canister	Tank Gasket	
GP1083167 	<p><b>NOTE: The canister should not fail. If leaking occurs, replace seal GP1059291.</b></p>  <p><b>** If tabs on guide or cap break, Replace with Kit GP1229656</b></p>	<p><b>1.28 GPF</b> 1216618 1216622 (Lined Tank)</p> <p><b>1.6 GPF</b> 1152861</p>	<p><b>1.28 GPF</b> GP51487</p>  <hr style="border-top: 1px dashed black;"/> <p><b>1.6 GPF</b> GP1018165-F 1024390</p> 	
GP1083167 		<p>1216617</p>	<p>GP51487</p> 	
GP1083167 		<p>GP1060299M (Mexico Only)</p>	<p><b>1.28 GPF</b> 1216618</p>	<p>GP51487</p> 
GP1083167 		<p>GP1060299M (Mexico Only)</p>	<p><b>1.28 GPF</b> 1142714</p> <p><b>1.6 GPF</b> 1145365</p>	<p>GP51487</p> 
GP1083167 		<p>GP1060299M (Mexico Only)</p>	<p><b>1.28 GPF</b> 1151862</p> <p><b>1.6 GPF</b> 1160809</p>	<p>GP51487</p> 
GP1083167 		<p>GP1060299M (Mexico Only)</p>	<p><b>1.28 GPF</b> 1117210</p> <p><b>1.6 GPF</b> 1069722 (Plastic Arm)</p> <p>1086115 (Metal Arm)</p>	<p>GP51487</p>  <hr style="border-top: 1px dashed black;"/> <p>GP1018165-F 1024390</p> 
GP1083167 		<p>GP1060299M (Mexico Only)</p>	<p><b>1.28 gpf</b> 1117210 1130564 (Lined Tank)</p> <p><b>1.6 gpf</b> 1158795 1158796 (Lined Tank)</p>	<p>GP51487</p> 

Note: Part numbers that have a "GP" prefix refer to a blister package. For example, GP1059291 is the same part as previous part number 1059291 but in a blister package.











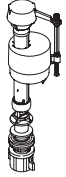
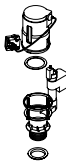

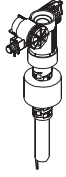
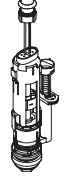

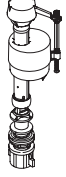
Canister (Dual-Flush) One- and Two-Piece Toilets  
Toilet

Toilet Details

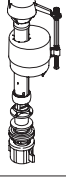
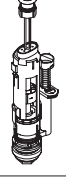
Canister  
(Dual-Flush) Toilets

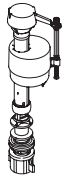
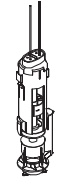
Product Name	Model Number	Tank Cover	Trip Lever
Cavata® 	K-45989 Tank: K-4137	1145294* 	1203699* 
Escala® 	K-3588 Tank: K-4472	1045184* 	1095688* 
Highline®  DUAL FLUSH <small>KOHLER</small>	K-45979 Tank: K-4136	84951* 	1208884* 
Persuade®  DUAL FLUSH <small>KOHLER</small>	K-3654 Tank: K-4419	1052066* 	1036156* 
Persuade Circ  DUAL FLUSH <small>KOHLER</small>	K-3753 Tank: K-4442	1101883* 	1072961* 
Persuade Curv  DUAL FLUSH <small>KOHLER</small>	K-3723, K-98864 Tank: K-4441	1116480* 1217371* (K-98864) 	1072961*  <hr style="border-top: 1px dashed black;"/> 1218922* (K-98864) 

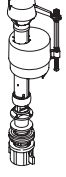
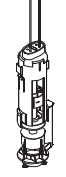
Canister (Dual-Flush) One- and Two-Piece Toilets  
 KOHLER® Genuine Parts

Float/Fill Valve	Flush Valve	Tank Gasket	Canister Seal
GP1083167 	1203698* 	GP51487 	1203764 
1052921 	1095687* 	1036170 	1131496 
GP1083167 	1208883* 	GP51487 	1203764 
GP1138930 	1087556 	1107584 	1131496 
GP1138930 	1145275* 	1107584 	1131496 
GP1138930 	1132466* 	1107584 	1131496 



Canister  
 (Dual-Flush) Toilets

Note: Part numbers that have a "GP" prefix refer to a blister package.  
 For example, GP1059291 is the same part as previous part number 1059291 but in a blister package.

Canister (Dual-Flush) One- and Two-Piece Toilets  
Toilet

Toilet Details

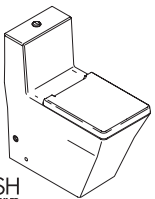
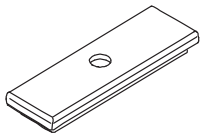
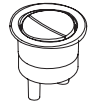
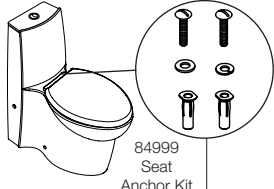
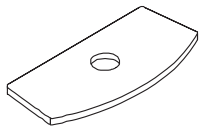
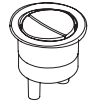
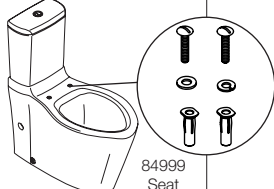

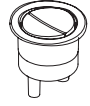
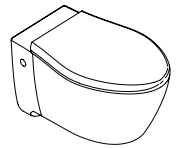
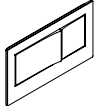
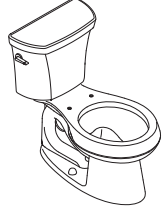
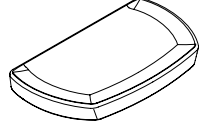
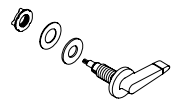







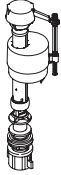



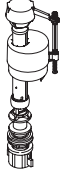

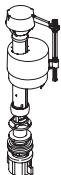

Canister  
(Dual-Flush) Toilets

Product Name	Model Number	Tank Cover	Trip Lever
<p>Rêve<sup>®</sup></p>  <p>DUAL FLUSH KOHLER</p>	<p>K-3797</p>	<p>1113930*</p> 	<p>1072961*</p> 
<p>Saile<sup>®</sup></p>  <p>DUAL FLUSH KOHLER</p> <p>84999 Seat Anchor Kit</p>	<p>K-3564 Artist Editions<sup>®</sup>: K-14338</p>	<p>1081363*</p> 	<p>1072961*</p> 
<p>Strela<sup>®</sup></p>  <p>DUAL FLUSH KOHLER</p> <p>84999 Seat Anchor Kit</p>	<p>K-3598 Tank: K-4742</p>	<p>1080568*</p> 	<p>1072961*</p> 
<p>Veil<sup>®</sup></p> 	<p>K-6303 Tank: K-6284</p>	<p>N/A</p>	<p>K-6298*</p> 
<p>Wellworth<sup>®</sup></p> 	<p>K-3987, K-3988, K-3989 Tank: K-4458</p>	<p>1138565*</p> 	<p>1208884* LH 1203699* RH</p> 

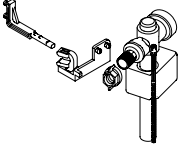
NOTES:

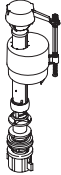

Canister (Dual-Flush) One- and Two-Piece Toilets  
 KOHLER® Genuine Parts

Float/Fill Valve	Flush Valve	Tank Gasket	Canister Seal
GP1138930 	1119360 	1118481 	1131496 
GP1138930 	1097231 	GP83996 	1131496 
GP1138930 	1113582* 	1107584 	1131496 
1155514 	1155519* 	1150348 	N/A
GP1083167 	1208885 LH 1224140 RH 	GP51487 	1203764 

Canister  
 (Dual-Flush) Toilets





**NOTES:**

Note: Part numbers that have a "GP" prefix refer to a blister package.  
 For example, GP1059291 is the same part as previous part number 1059291 but in a blister package.

# Touchless

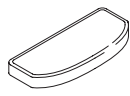
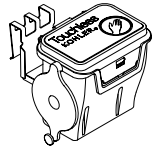

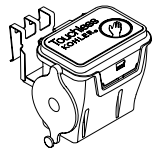

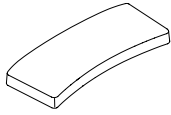
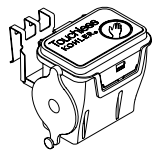

## Toilet

## Toilet Details

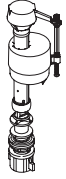
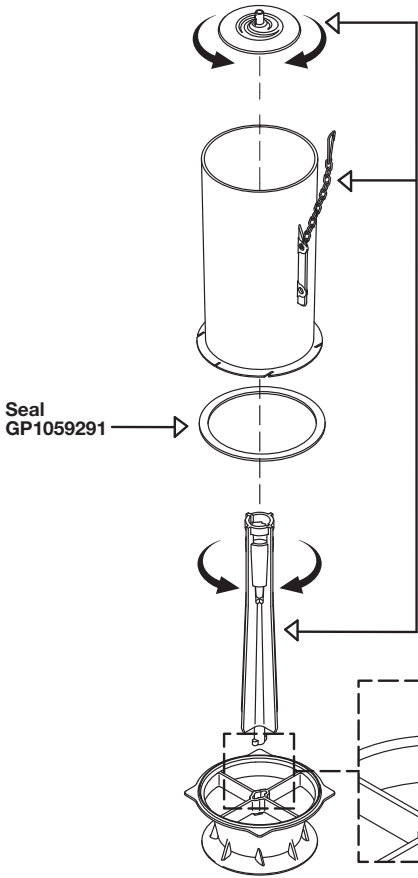
Product Name	Model Number	Tank Cover	Touchless
Cimmaron® Elongated 	K-6418 Tank: K-5692	1086929* 	1224130 
Cimmaron Round-Front 	K-6419 Tank: K-5693	1086929* 	1224130 
San Souci® 	K-4000	1182368* 	1224130 

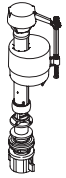
Touchless

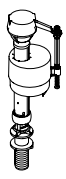
# Touchless KOHLER® Genuine Parts

Float/Fill Valve	Chain/Guide/Seal	Canister	Tank Gasket
<p>GP1083167</p> 	<p><b>NOTE: The canister should not fail. If leaking occurs, replace seal GP1059291.</b></p>  <p style="text-align: center;"><b>Cap, Chain, &amp; Guide GP1229656</b></p> <p>Seal GP1059291 →</p> <p><b>** If tabs on guide or cap break, Replace with Kit GP1229656</b></p>	<p>1222695</p>	<p>1112256</p> 
<p>GP1138930</p> 		<p>1222694</p>	<p>1112256</p> 
<p>1237539</p> 		<p>1227235</p>	<p>GP83996</p> 













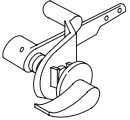

**Touchless**

Note: Part numbers that have a "GP" prefix refer to a blister package. For example, GP1059291 is the same part as previous part number 1059291 but in a blister package.

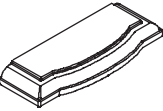
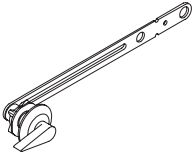
## 2-Inch Flapper One-Piece Toilets

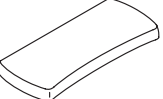

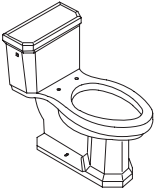
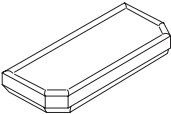



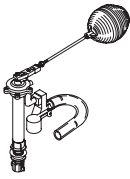
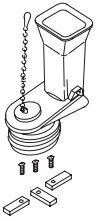

### Toilet

### Toilet Details

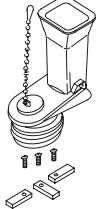
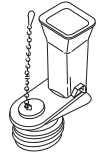
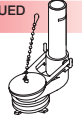
Product Name	Model Number	Tank Cover	Trip Lever
Cabernet™  	K-3401 K-3408	82848*  82565* 	Various trip levers; see <a href="http://KOHLER.com/ServiceParts">KOHLER.com/ServiceParts</a> .
Champlain™  	K-3390	Discontinued No Replacement	77046* 
Channel™, Bolton™   INGENIUM. <small>KOHLER</small>	K-3655 K-3670	Discontinued No Replacement	500195* 
Devonshire®   INGENIUM. <small>KOHLER</small>	K-3488	1021921* 	1031599* 
Gabrielle™   INGENIUM. <small>KOHLER</small>	K-3322 Artist Editions®: K-14257, K-14258, K-14286	85407* 	1025329* LH  1025330* RH 
Kathryn®  	K-3324 Artist Editions: K-14268	1006066* 	1006495*  85085* 

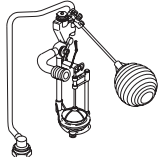
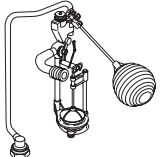
2-Inch Flapper One-Piece Toilets

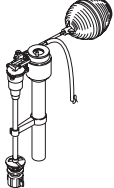
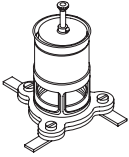
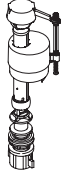
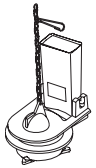
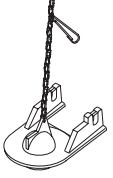
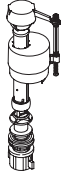
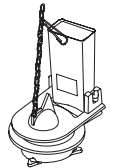
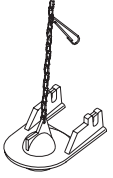
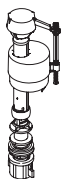
## 2-Inch Flapper One-Piece Toilets KOHLER® Genuine Parts

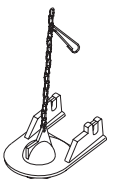
Float/Fill Valve	Flush Valve	Flush Ball/Flapper
<p>84499</p> 	<p>83650</p> 	<p>GP83064</p> 
	<p>83094</p>  <p><b>DISCONTINUED</b> Use 83094</p>  <p>If your toilet currently has this style flush valve and flapper, we recommend they be replaced with flush valve 83094 to prevent potential water damage.</p>	<p>GP83064</p> 
<p>30669</p> 	<p>30669</p> 	<p>GP88921</p> 
<p>30683</p> 	<p>30679 Discontinued No Replacement</p> 	<p>N/A</p>
<p>GP1138930</p> 	<p>1032640</p> 	<p>GP1078440</p> 
<p>GP1138930</p> 	<p>87998</p> 	<p>GP1078440</p> 
<p>GP1138930</p> 	<p>87998</p> 	<p>GP1078440</p> 







2-Inch Flapper  
One-Piece Toilets

Note: Part numbers that have a "GP" prefix refer to a blister package.  
For example, GP1059291 is the same part as previous part number 1059291 but in a blister package.

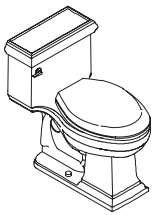
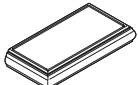
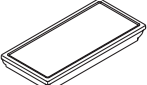
## 2-Inch Flapper One-Piece Toilets

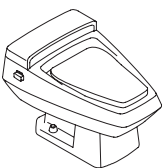
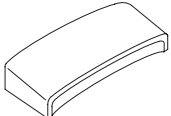
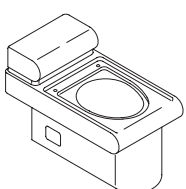
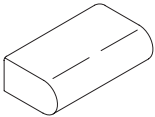
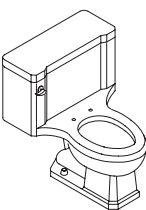

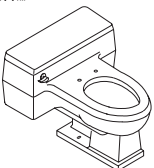







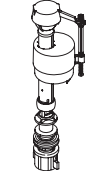

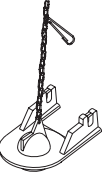
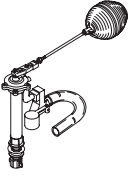
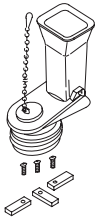
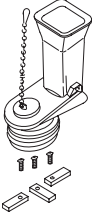
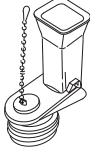
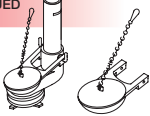
### Toilet

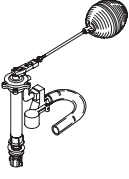
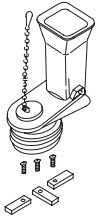
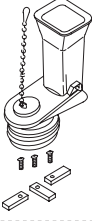
### Toilet Details

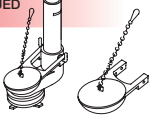
Product Name	Model Number	Tank Cover	Trip Lever
Memoirs <sup>®</sup> 	K-3451 K-3453	88871* Classic  88872* Stately 	1039863* 
Palarre <sup>™</sup> 	K-3383	82812* (19 <sup>7</sup> / <sub>8</sub> " 83229* (19 <sup>1</sup> / <sub>2</sub> " Discontinued No Replacement 	Various trip levers; see <a href="http://KOHLER.com/ServiceParts">KOHLER.com/ServiceParts</a> .
Pillow Talk <sup>™</sup> 	K-3378	82530* 	Various trip levers; see <a href="http://KOHLER.com/ServiceParts">KOHLER.com/ServiceParts</a> .
Placid <sup>™</sup> 	K-3405 K-3600	Discontinued No Replacement	51170* 
Pompton <sup>™</sup> 	K-3400	Discontinued	51170* 

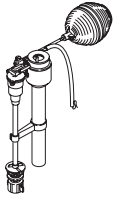
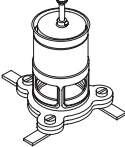
2-Inch Flapper One-Piece Toilets

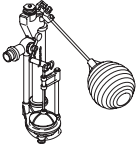
## 2-Inch Flapper One-Piece Toilets KOHLER® Genuine Parts

Float/Fill Valve	Flush Valve	Flush Ball/Flapper
<p>GP1138930</p> 	<p>87998</p> 	<p>GP1078440</p> 
<p>84499</p>  	<p>83650</p>  <hr style="border-top: 1px dashed black;"/> <p>83094</p>  <div style="display: inline-block; border: 1px solid red; padding: 2px; color: red; font-weight: bold; margin-right: 10px;">DISCONTINUED Use 83094</div>  <p>If your toilet currently has this style flush valve and flapper, we recommend they be replaced with flush valve 83094 to prevent potential water damage.</p>	<p>GP83064</p>  <p>GP83064</p> 
<p>84499</p>  	<p>83650</p>  <hr style="border-top: 1px dashed black;"/> <p>83094</p>  <div style="display: inline-block; border: 1px solid red; padding: 2px; color: red; font-weight: bold; margin-right: 10px;">DISCONTINUED Use 83094</div>  <p>If your toilet currently has this style flush valve and flapper, we recommend they be replaced with flush valve 83094 to prevent potential water damage.</p>	<p>GP83064</p>  <p>GP83064</p> 
<p>30683</p> 	<p>30679 Discontinued No Replacement</p> 	<p>N/A</p>
<p>30668</p> 	<p>30668</p> 	<p>GP88921</p> 







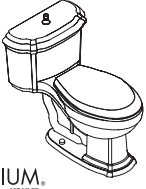
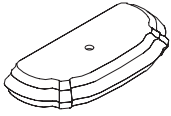

2-Inch Flapper  
One-Piece Toilets

Note: Part numbers that have a "GP" prefix refer to a blister package.  
For example, GP1059291 is the same part as previous part number 1059291 but in a blister package.

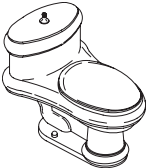
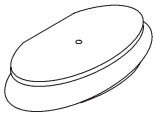
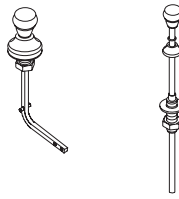
# 2-Inch Flapper One-Piece Toilets

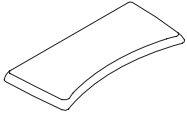
## Toilet

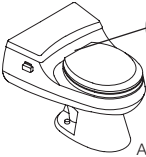
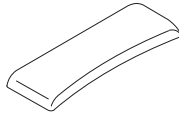

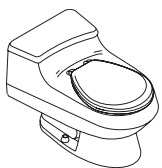
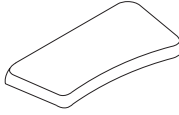







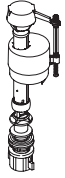
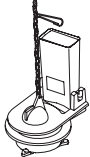

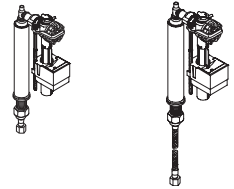





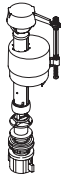

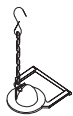

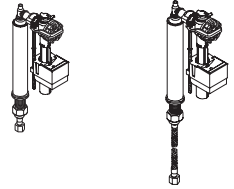

## Toilet Details

Product Name	Model Number	Tank Cover	Trip Lever
Portrait®  INGENIUM. <small>KOHLER</small>	K-3357 Artist Editions®: K-14261	89809* 	83725* 
Revival® 	K-3360, K-3612 Artist Editions: K-14230	1000832* 	1000833*    83725* 
Rosario™  84999 Seat Anchor Kit	K-3434	81804* 	78423* 
Rialto®  84999 Seat Anchor Kit	K-3386 K-3804	84252* 	85114* 
Rialto 	K-3402	81180* 	Various trip levers; see <a href="http://KOHLER.com/ServiceParts">KOHLER.com/ServiceParts</a> .

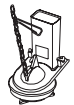
2-Inch Flapper One-Piece Toilets

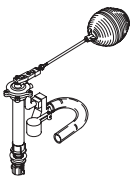
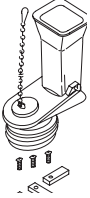
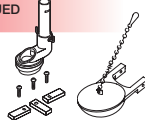
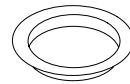

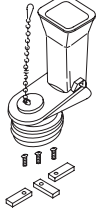
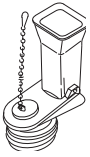
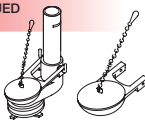
## 2-Inch Flapper One-Piece Toilets KOHLER® Genuine Parts

Float/Fill Valve	Flush Valve	Tank Gasket	Flush Ball/Flapper
GP1138930 	89827 1060862 	GP83996 	GP89825 
1007490      1068033 GP1068030 For Rigid Connection      For Flex Connection 	84305 	GP83996 	GP1078440 
	1000837 	84676 	GP84995 
GP1138930 	86972 	84676 	GP84995 
	83093 	GP83888 	GP83064 
GP1068030      1068033 For Rigid Connection      For Flex Connection 	1078578 	84676 	GP84995 
	84302 	GP83996 	GP1078440 
84499 	83650  <p style="background-color: #f08080; padding: 2px; display: inline-block;">DISCONTINUED Use 83650</p>  <p>If your toilet currently has this style flush valve and flapper, we recommend they be replaced with flush valve 83650 to prevent potential water damage.</p>	53410 	GP83064 
		83095  <p style="background-color: #f08080; padding: 2px; display: inline-block;">DISCONTINUED Use 83095</p>  <p>If your toilet currently has this style flush valve and flapper, we recommend they be replaced with flush valve 83095 to prevent potential water damage.</p>	GP83888 



2-Inch Flapper One-Piece Toilets

Note: Part numbers that have a "GP" prefix refer to a blister package. For example, GP1059291 is the same part as previous part number 1059291 but in a blister package.

# 2-Inch Flapper One-Piece Toilets



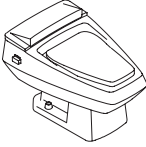
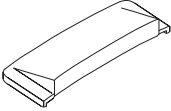
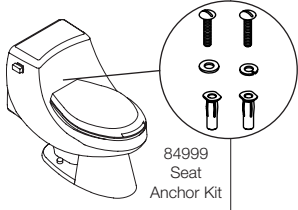
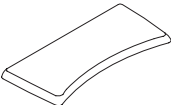

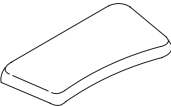





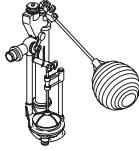

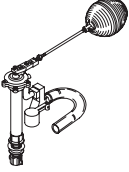
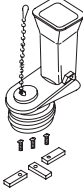

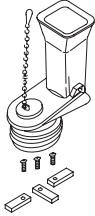
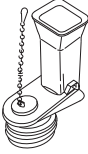
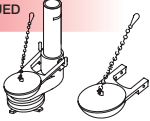
## Toilet

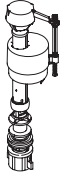
## Toilet Details

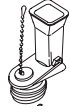
Product Name	Model Number	Tank Cover	Trip Lever
<p>Rochelle™</p> 	<p>K-3385</p>	<p>84079* (19<sup>3</sup>/<sub>8</sub>" 83230* (19<sup>1</sup>/<sub>4</sub>"</p> 	<p>Various trip levers; see KOHLER.com/ServiceParts.</p>
<p>San Martine®</p>  <p>84999 Seat Anchor Kit</p>	<p>K-3435 Artist Editions®: K-14289, K-14290, K-14291</p>	<p>81804*</p> 	<p>Various trip levers; see KOHLER.com/ServiceParts.</p>
<p>San Miguel™</p> 	<p>K-3406</p>	<p>82931*</p> 	<p>Various trip levers; see KOHLER.com/ServiceParts.</p>

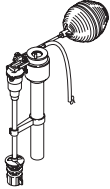
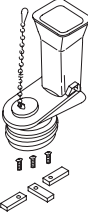
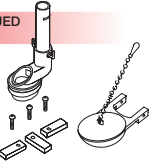
2-Inch Flapper One-Piece Toilets

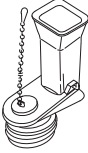
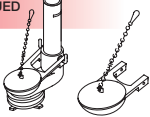
## 2-Inch Flapper One-Piece Toilets KOHLER® Genuine Parts

Float/Fill Valve	Flush Valve	Flush Ball/Flapper
<p>30668 (prior 1990)</p> 	<p>30668</p> 	<p>GP88921</p> 
<p>84499</p> 	<p>83650</p> 	<p>GP83064</p> 
	<p>83094</p>  <p><b>DISCONTINUED</b> Use 83094</p>  <p>If your toilet currently has this style flush valve and flapper, we recommend they be replaced with flush valve 83094 to prevent potential water damage.</p>	<p>GP83064</p> 
<p>GP1138930</p> 	<p>86972</p> 	<p>GP84995</p> 
	<p>83093</p> 	<p>GP83064</p> 
<p>30671</p> 	<p>84216</p>  <p><b>DISCONTINUED</b> Use 84216</p>  <p>If your toilet currently has this style flush valve and flapper, we recommend they be replaced with flush valve 84216 to prevent potential water damage.</p>	<p>GP49114</p> 
	<p>84217</p>  <p><b>DISCONTINUED</b> Use 84217</p>  <p>If your toilet currently has this style flush valve and flapper, we recommend they be replaced with flush valve 84217 to prevent potential water damage.</p>	<p>GP49114</p> 







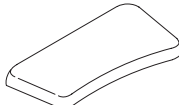
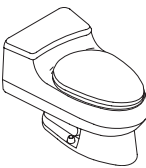

2-Inch Flapper  
One-Piece Toilets

Note: Part numbers that have a "GP" prefix refer to a blister package.  
For example, GP1059291 is the same part as previous part number 1059291 but in a blister package.

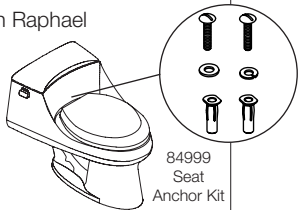
## 2-Inch Flapper One-Piece Toilets

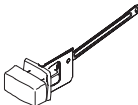
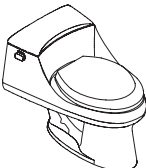
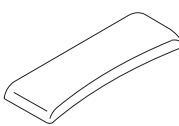
### Toilet

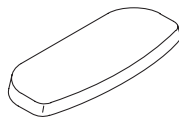









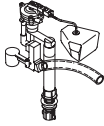
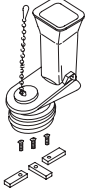
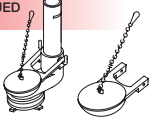

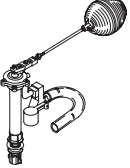
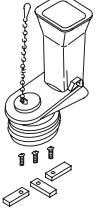
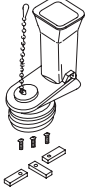
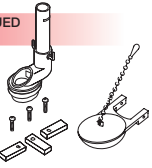

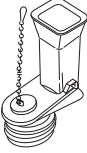
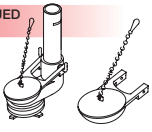
### Toilet Details

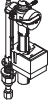
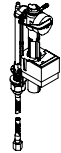
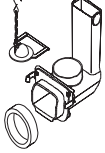
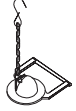
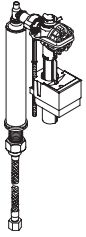
Product Name	Model Number	Tank Cover	Trip Lever
San Raphael® 	K-3395	82931* 	Various trip levers; see <a href="http://KOHLER.com/ServiceParts">KOHLER.com/ServiceParts</a> .
San Raphael 	K-3397	82931* 	Various trip levers; see <a href="http://KOHLER.com/ServiceParts">KOHLER.com/ServiceParts</a> .
San Raphael  INGENIUM. <small>KOHLER</small>	K-3466 K-3467	1010658* 	1013521* 
San Raphael  INGENIUM. <small>KOHLER</small>	K-3384	84250* 	85114* 
Santa Rosa™ 	K-3323 K-3803 K-11899	88497* 	87115* 

2-Inch Flapper One-Piece Toilets

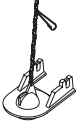
\*Include the color or finish code after the part number when ordering.

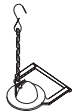
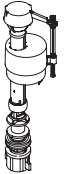
## 2-Inch Flapper One-Piece Toilets KOHLER® Genuine Parts

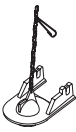
Float/Fill Valve	Flush Valve	Flush Ball/Flapper
<p>43119</p> <p>Discontinued No Replacement</p> 	<p>83650</p>  <p><b>DISCONTINUED</b> Use 83650</p>  <p>If your toilet currently has this style flush valve and flapper, we recommend they be replaced with flush valve 83650 to prevent potential water damage.</p>	<p>GP83064</p> 
<p>84499</p>  	<p>83650</p>  <p><b>DISCONTINUED</b> Use 83650</p>  <p>If your toilet currently has this style flush valve and flapper, we recommend they be replaced with flush valve 83650 to prevent potential water damage.</p>	<p>GP83064</p> 
	<p>83095</p>  <p><b>DISCONTINUED</b> Use 83095</p>  <p>If your toilet currently has this style flush valve and flapper, we recommend they be replaced with flush valve 83095 to prevent potential water damage.</p>	<p>GP83064</p> 
<p>1013282      1068031</p> <p>For Rigid Connection      For Flex Connection</p>  	<p>1013944</p> 	<p>GP84995</p> 
<p>GP1068030</p> 	<p>1016123</p> 	<p>1010376</p> 
	<p>84284</p> 	<p>GP1078440</p> 
	<p>84996</p> 	<p>GP84995</p> 
<p>GP1138930</p> 	<p>87998</p> 	<p>GP1078440</p> 







2-Inch Flapper  
One-Piece Toilets

Note: Part numbers that have a "GP" prefix refer to a blister package.  
For example, GP1059291 is the same part as previous part number 1059291 but in a blister package.

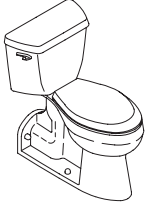
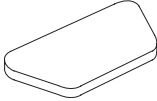
## 2-Inch Flapper Two-Piece Toilets

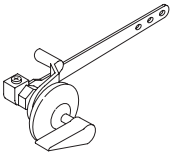
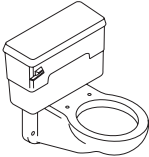
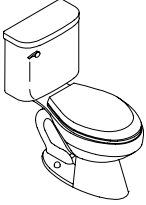
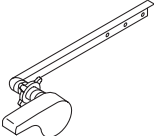

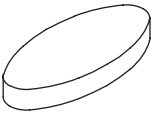







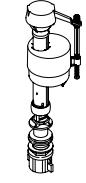
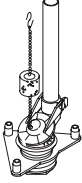

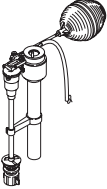

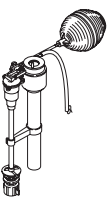
### Toilet

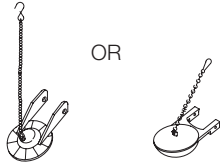
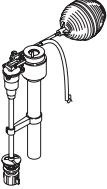
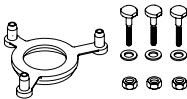
### Toilet Details

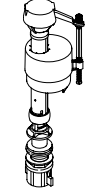
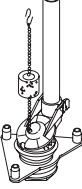
Product Name	Model Number	Tank Cover	Trip Lever
Barrington™ Water-Guard 	K-3530, K-3535, K-3536 Tank: K-4519	80471* 80484* (Locks) 	Various trip levers; see <a href="http://KOHLER.com/ServiceParts">KOHLER.com/ServiceParts</a> .
Bolton™ Aqua Vent 	K-3450 Tank: K-4505 K-3475 Tank: K-4509	Discontinued	500189* 
Cayuga™ 	K-3440 Tank: K-4509	Discontinued	Various trip levers; see <a href="http://KOHLER.com/ServiceParts">KOHLER.com/ServiceParts</a> .
Confidante™ 	K-3556, K-3557 Tank: K-4456	Discontinued	84625* 
Couture™ 	K-3471, K-3472 Tank: K-4591 Artist Editions®: K-14213 Tank: K-14215 K-14250 Tank: K-14252	Discontinued	Various trip levers; see <a href="http://KOHLER.com/ServiceParts">KOHLER.com/ServiceParts</a> .
INGENIUM. <small>KOHLER</small> Couture 	K-3477, K-3478, K-3479, K-3480 Tank: K-4605	85314* 	Various trip levers; see <a href="http://KOHLER.com/ServiceParts">KOHLER.com/ServiceParts</a> .
Couture Water-Guard® 	K-3470 Tank: K-4501 Artist Editions: K-14110 Tank: K-14108 K-14150 Tank: K-14154 K-14128 Tank: K-14129	80473* (18 1/4") Discontinued No Replacement 80576* (19 1/2") 	Various trip levers; see <a href="http://KOHLER.com/ServiceParts">KOHLER.com/ServiceParts</a> .

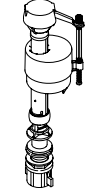
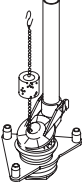
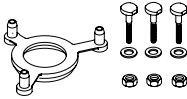
2-Inch Flapper Two-Piece Toilets

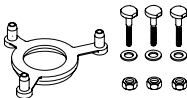
## 2-Inch Flapper Two-Piece Toilets KOHLER® Genuine Parts

Float/Fill Valve	Flush Valve	Tank Gasket	Flush Ball/Flapper
<p>GP1138930</p> 	<p>85406</p> 	<p>GP51487</p> 	<p>GP87449</p> 
<p>30671</p> 	<p>Discontinued</p>	<p>Discontinued</p>	<p>GP87449</p> 
<p>30671</p> 	<p>Discontinued</p>	<p>51531 GP52050</p> 	<p>GP87449 OR GP49114</p> 
<p>30671</p> 	<p>Discontinued</p>	<p>GP51487</p> 	<p>GP85160</p> 
<p>GP1138930</p> 	<p>1003068</p> 	<p>GP51487</p> 	<p>GP85160</p> 
<p>GP1138930</p> 	<p>85431</p> 	<p>GP51487</p> 	<p>GP85160</p> 
<p>30654</p> 	<p>Discontinued</p>	<p>GP51487</p> 	<p>GP87449</p> 









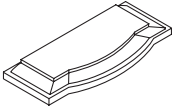
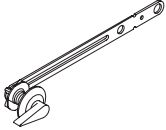

2-Inch Flapper  
Two-Piece Toilets

Note: Part numbers that have a "GP" prefix refer to a blister package.  
For example, GP1059291 is the same part as previous part number 1059291 but in a blister package.

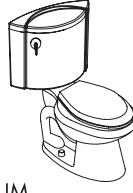
## 2-Inch Flapper Two-Piece Toilets

### Toilet

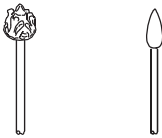

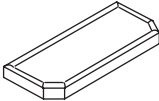
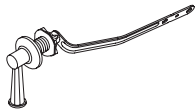





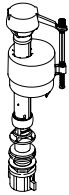
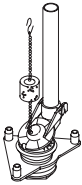

### Toilet Details

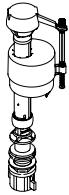
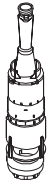
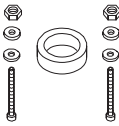
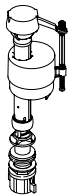
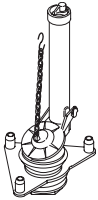
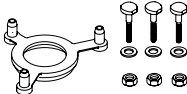
Product Name	Model Number	Tank Cover	Trip Lever
Devonshire® 	K-3457 Tank: K-4619	84652* 	85086* 
Fleur® 	K-3417 Tank: K-4586	Discontinued	Various trip levers; see <a href="http://KOHLER.com/ServiceParts">KOHLER.com/ServiceParts</a> .
Fleur 	K-3447 Tank: K-4606	83702* 	83725* 
Folio® 	K-3419, K-3445, K-3448, K-3449, K-3454 Tank: K-4447	84274* 	Various trip levers; see <a href="http://KOHLER.com/ServiceParts">KOHLER.com/ServiceParts</a> .
INGENIUM. KOHLER. Iron Works® 	K-3456, K-3463 Tank: K-4401	89970* 	1010200*    1010199* 
Kathryn® 	K-3484 Tank: K-4403	1015781* 	1006495* 
INGENIUM. KOHLER.			

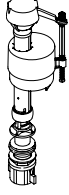
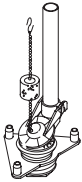
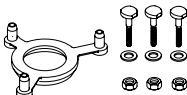
2-Inch Flapper Two-Piece Toilets

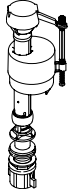
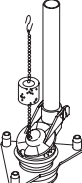
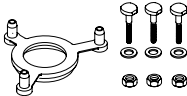

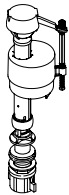
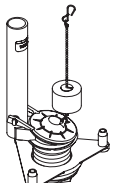
## 2-Inch Flapper Two-Piece Toilets KOHLER® Genuine Parts

Float/Fill Valve	Flush Valve	Tank Gasket	Flush Ball/Flapper
GP1138930 	84665 	GP51487 	GP85160 
GP1138930 	Discontinued - No Replacement 	84539 	N/A
GP1138930 	85302 	GP51487 	GP87449 
GP1138930 	85323 	GP51487 	GP85160 
GP1138930 	1003068 	GP51487 	GP85160 
GP1138930 	1020751 	GP51487 	GP85160 













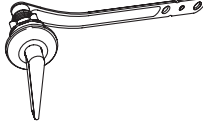

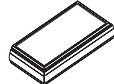
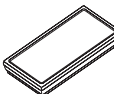
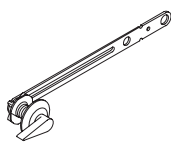

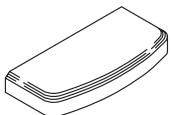
2-Inch Flapper  
Two-Piece Toilets

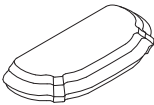
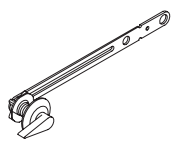
Note: Part numbers that have a "GP" prefix refer to a blister package.  
For example, GP1059291 is the same part as previous part number 1059291 but in a blister package.

## 2-Inch Flapper Two-Piece Toilets



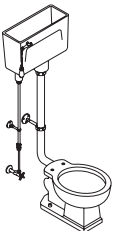







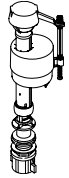
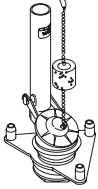

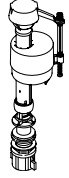
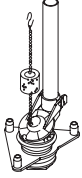
### Toilet

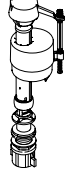
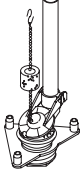
### Toilet Details

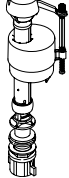
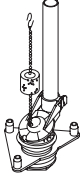
Product Name	Model Number	Tank Cover	Trip Lever
Leighton®  INGENIUM. <small>KOHLER</small>	K-3486, K-3651 Tank: K-4628	1016946* 	1022562* 
Memoirs®  INGENIUM. <small>KOHLER</small>	K-3429, K-3452 Tank: K-4454 K-3439, K-3462 Tank: K-4464	84406* Classic  84407* Stately 	85086* 
Pinoir®  INGENIUM. <small>KOHLER</small>	K-3465, K-3482, K-3483, K-3485 Tank: K-4609	1015137* 	85085 LH*    1007913 RH* 
Portrait® Lite  INGENIUM. <small>KOHLER</small>	K-3591, K-3490, K-3491 Tank: K-4590, K-4807 Artist Editions®: K-14178 Tank: K-14179 K-14247 Tank: K-14249	80625* 	85086* 
Revival®  INGENIUM. <small>KOHLER</small>	K-3555 Tank: K-3613 K-3455 Tank: K-4445 Artist Editions: K-14239 Tank: K-14241	83834* 	83725* 
Serif®  INGENIUM. <small>KOHLER</small>	K-3444, K-3461, K-3464, K-3468 Tank: K-4608	1032188* 	83725* 
Vintage® 	K-3410 Tank: K-4515	Discontinued	21583* Discontinued No Replacement
	K-3411, K-3412 Tank: K-4516	Discontinued	21540* 

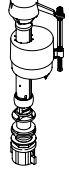
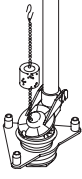
2-Inch Flapper Two-Piece Toilets

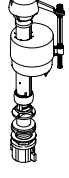
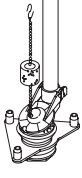
## 2-Inch Flapper Two-Piece Toilets KOHLER® Genuine Parts

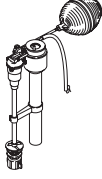
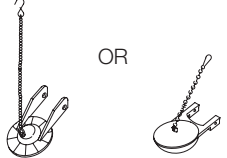
Float/Fill Valve	Flush Valve	Tank Gasket	Flush Ball/Flapper
GP1138930 	1022551 	GP51487 	GP85160 
GP1138930 	1042831 	GP51487 	GP85160 
GP1138930 	1015139 	GP51487 	GP87449 
GP1138930 	87373 (1.6 GPF) 	GP51487 	GP85160 
GP1138930 	85159 	GP51487 	GP85160 
GP1138930 	1004808 	GP51487 	GP85160 
76171 	Discontinued	Discontinued	GP87449      GP49114 OR 











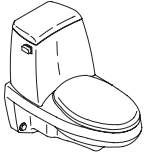
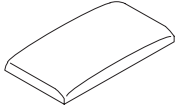
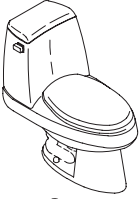

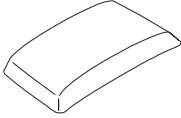
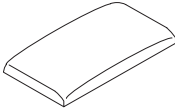
2-Inch Flapper  
Two-Piece Toilets

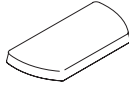
Note: Part numbers that have a "GP" prefix refer to a blister package.  
For example, GP1059291 is the same part as previous part number 1059291 but in a blister package.

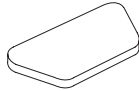
## 2-Inch Flapper Two-Piece Toilets

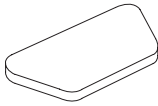

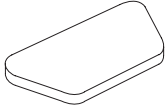

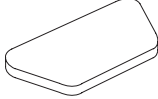





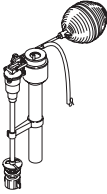

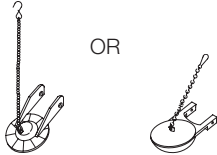
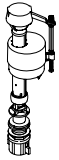
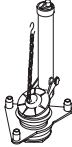
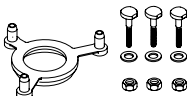

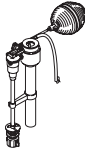

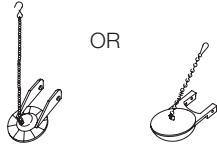
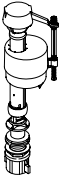
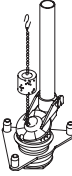
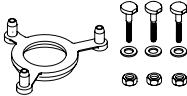
### Toilet

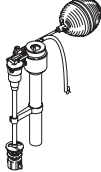
### Toilet Details

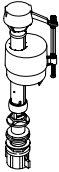
Product Name	Model Number	Tank Cover	Trip Lever
Wellesley™ Water-Guard® 	K-3441 Tank: K-4209	80424* Discontinued No Replacement 	Various trip levers; see <a href="http://KOHLER.com/ServiceParts">KOHLER.com/ServiceParts</a> .
Wellington™  	K-3446 Tank: K-4646 Artist Editions®: K-14210 Tank: K-14212	83584* 	Various trip levers; see <a href="http://KOHLER.com/ServiceParts">KOHLER.com/ServiceParts</a> .
	K-3415 Tank: K-4504 Artist Editions: K-14133 Tank: K-14137 K-14143 Tank: K-14147 K-14076 Tank: K-14078	80424* Discontinued No Replacement 	Various trip levers; see <a href="http://KOHLER.com/ServiceParts">KOHLER.com/ServiceParts</a> .
Wellworth®, Highline® 	K-3433, K-3438 Tank: K-4621	84095* 	30324* 
	K-11450, K-11470, K-3422, K-3423, K-3432, K-3427, K-3481 Tank: K-4620	84591* 	87114* 
INGENIUM. <small>KOHLER</small> Highline Water-Guard 	K-3527 Tank: K-4518	80471* 80484* (Locks) 	87115* 
Wellworth 	K-3407, K-3420, K-3421, K-3428 Tank: K-4512 K-3414 Tank: K-4597	82869* (7 <sup>3</sup> / <sub>4</sub> "") 80625* (10") Discontinued 	Various trip levers; see <a href="http://KOHLER.com/ServiceParts">KOHLER.com/ServiceParts</a> .
Wellworth, Northline Water-Guard 	K-3520, K-3521 Tank: K-4519	80471* 80484* (Locks) 	Various trip levers; see <a href="http://KOHLER.com/ServiceParts">KOHLER.com/ServiceParts</a> .

2-Inch Flapper  
Two-Piece Toilets

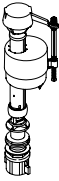
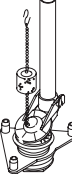
## 2-Inch Flapper Two-Piece Toilets KOHLER® Genuine Parts

Float/Fill Valve	Flush Valve	Tank Gasket	Flush Ball/Flapper
<p>30652</p> 	<p>Discontinued</p>	<p>GP51487</p> 	<p>GP87449    GP49114</p> <p>OR</p> 
<p>GP1138930</p> 	<p>85311</p> 	<p>GP51487</p> 	<p>GP87449</p> 
<p>30652</p> 	<p>Discontinued</p>	<p>GP51487</p> 	<p>GP87449    GP49114</p> <p>OR</p> 
<p>GP1138930</p> 	<p>Discontinued</p> 	<p>GP51487</p> 	<p>GP85160</p> 
<p>30671</p> 	<p>Discontinued</p>	<p>GP51487</p> 	<p>GP49114</p> 
<p>GP1138930</p> 	<p>1003068</p> 	<p>GP51487</p> 	<p>GP85160</p> 
<p>GP1138930</p> 	<p>85406</p> 	<p>GP51487</p> 	<p>GP87449</p> 

2-Inch Flapper  
Two-Piece Toilets

Note: Part numbers that have a "GP" prefix refer to a blister package.  
For example, GP1059291 is the same part as previous part number 1059291 but in a blister package.

## 2-Inch Flapper Two-Piece Toilets





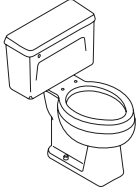
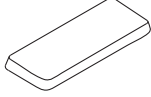
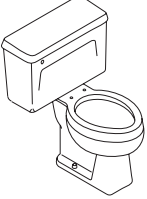
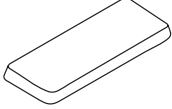

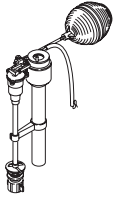

### Toilet

### Toilet Details

Product Name	Model Number	Tank Cover	Trip Lever
Wellworth®, Highline®, Tylon™, Barlow™ 	K-3510, K-3512, K-3514 Tank: K-4524	81187* 	Various trip levers; see <a href="http://KOHLER.com/ServiceParts">KOHLER.com/ServiceParts</a> .
Wellworth Water-Guard® 	K-3500, K-3502, K-3504 Tank: K-4509	81509* 	Various trip levers; see <a href="http://KOHLER.com/ServiceParts">KOHLER.com/ServiceParts</a> .

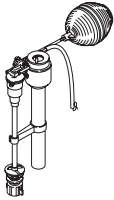
**NOTES:**

## 2-Inch Flapper Two-Piece Toilets KOHLER® Genuine Parts







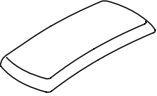
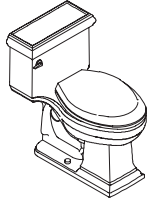
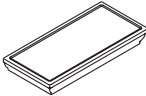

Float/Fill Valve	Flush Valve	Tank Gasket	Flush Ball/Flapper
<p style="text-align: center;">30671</p> 	N/A	<p style="text-align: center;">51531</p>  <p style="text-align: center;">GP52050</p> 	<p style="text-align: center;">GP87449      GP49114</p> <p style="text-align: center;">OR</p>  
<p style="text-align: center;">30672</p> 	N/A	<p style="text-align: center;">51531</p>  <p style="text-align: center;">GP52050</p> 	<p style="text-align: center;">GP87449      GP49114</p> <p style="text-align: center;">OR</p>  

**NOTES:**

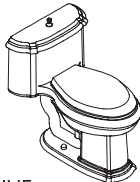
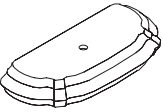
Note: Part numbers that have a “GP” prefix refer to a blister package.  
For example, GP1059291 is the same part as previous part number 1059291 but in a blister package.

# 3/4-Inch Flapper One- and Two-Piece Toilets



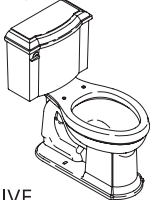
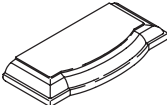
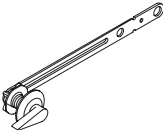







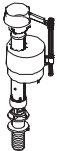



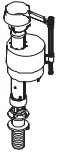
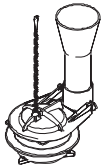

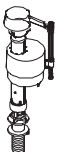
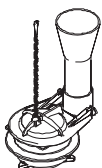

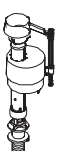
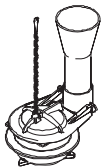

## Toilet Details

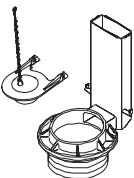
Product Name	Model Number	Tank Cover	Trip Lever
Cimarron®  CLASS FIVE. <small>KOHLER</small>	K-3489 K-3802 K-11889	1036367* 	1034693* LH  1036058* RH 
Gabrielle™  CLASS FIVE. <small>KOHLER</small>	K-3513, K-3608 Artist Editions®: K-14343, K-14344, K-14345, K-14346	85407* 	1068627* LH  1080378* RH 
Memoirs®  CLASS FIVE. <small>KOHLER</small>	K-3451, K-3453	88871* Classic  88872* Stately 	1039863* 
Portrait®  CLASS FIVE. <small>KOHLER</small>	K-3506	89809* 	83725* 
Bancroft®  CLASS FIVE. <small>KOHLER</small>	K-3487 Tank: K-4633	1033723* 	1042212* 
Cimarron  CLASS FIVE. <small>KOHLER</small>	<b>1.6 GPF</b> K-3496, K-3497, K-3499, K-11465 Tank: K-4634 <b>1.28 GPF</b> K-3496-HE Tank: K-4634-HE	1015867* 	1034693* LH  1036058* RH 
Devonshire®  CLASS FIVE. <small>KOHLER</small>	K-3503 Tank: K-4708	1044820* 	85086* 

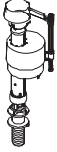
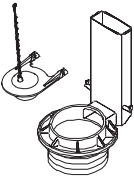
3/4-Inch Flapper One- and Two-Piece Toilets

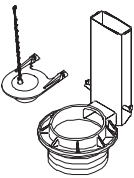

## 3/4-Inch Flapper One- and Two-Piece Toilets KOHLER® Genuine Parts

Float/Fill Valve	Flush Valve	Tank Gasket	Flush Ball/Flapper
GP1083167 	1044458 	GP83996 	GP1039444 
GP1083167 	1068622 	GP83996 	GP1067183 
GP1083167 	1039861 	GP83996 	GP1039444 
GP1083167 	1060862 	GP83996 	GP1060740 
GP1083167 	1042499 	GP1018165-F 	1024390 
GP1083167 	1024385 	GP1018165-F 	1024390 
GP1083167 	1042499 	GP1018165-F 	1024390 

3/4-Inch Flapper  
One- and Two-Piece Toilets

Note: Part numbers that have a "GP" prefix refer to a blister package.  
For example, GP1059291 is the same part as previous part number 1059291 but in a blister package.

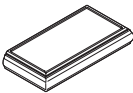
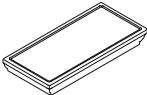
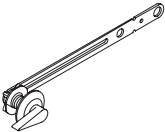

# 3/4-Inch Flapper One- and Two-Piece Toilets

## Toilet Details

Product Name	Model Number	Tank Cover	Trip Lever
<p>Memoirs<sup>®</sup></p>  <p>CLASS FIVE. KOHLER</p>	<p>K-11460, K-3511, K-3526 Tank: K-4492</p> <p>K-3532, K-3542 Tank: K-4485</p> <p>K-11461, K-3509, K-3515 Tank: K-4491</p> <p>K-3533, K-3548 Tank: K-4473</p>	<p>1052861* Classic</p>  <p>1052862* Stately</p> 	<p>85086*</p> 

**NOTES:**

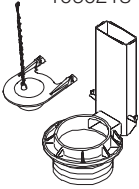
# 3/4-Inch Flapper One- and Two-Piece Toilets KOHLER® Genuine Parts





Float/Fill Valve	Flush Valve	Tank Gasket	Flush Ball/Flapper
<p>GP1083167</p> 	<p>1060218</p> 	<p>GP1018165-F      1024390</p> 	<p>GP1078441</p> 

**NOTES:**

Note: Part numbers that have a “GP” prefix refer to a blister package.  
For example, GP1059291 is the same part as previous part number 1059291 but in a blister package.

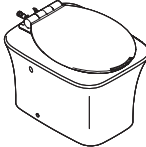
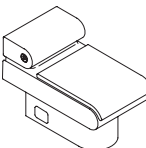
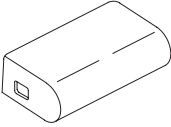
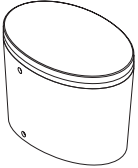

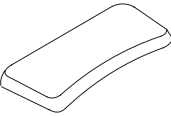

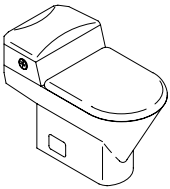
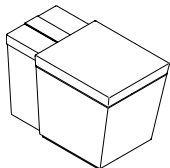
Toilet

Toilet Details

Product Name	Model Number	Tank Cover	Trip Lever
Fountainhead® 	K-3524	N/A	N/A
POWER LITE. KOHLER.	Call Technical Support 800-4KOHLER		
Pillow Talk™ 	K-3379	83675* 	Various trip levers; see KOHLER.com/ServiceParts.
POWER LITE. KOHLER.	Call Technical Support 800-4KOHLER		
Purist® Hatbox 	K-3492	N/A	N/A
POWER LITE. KOHLER.	Call Technical Support 800-4KOHLER		
San Raphael®  <p>84999 Seat Anchor Kit</p>	K-3607 K-3393 K-3398	1055954* 	81996* 
POWER LITE. KOHLER.	Call Technical Support 800-4KOHLER		
Trocadero® 	K-3437	N/A	Various trip levers; see KOHLER.com/ServiceParts.
POWER LITE. KOHLER.	Call Technical Support 800-4KOHLER		
Numi® 	K-3900	N/A	1183987* (User Interface)
	K-3901	N/A	K-7420* (User Interface)
Call Technical Support 800-4KOHLER			

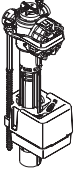
Numi/Power Lite®  
One-Piece Toilets

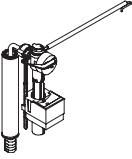
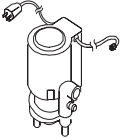
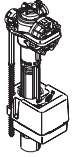
**Numi®/Power Lite® One-Piece Toilets**  
**KOHLER® Genuine Parts**

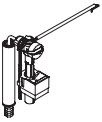
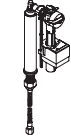
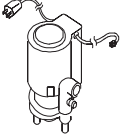
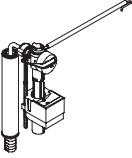
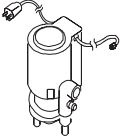
Float/Fill Valve	Flush Valve	Seat	Misc
1097551 	1044465 (Pump) 	1057635*	N/A
Call Technical Support 800-4KOHLER			
1007489 	84153 (Pump) 	74929*	N/A
Call Technical Support 800-4KOHLER			
1043213 	1044465 (Pump) 	1022679*	N/A
Call Technical Support 800-4KOHLER			
1007489 For Rigid Connection 	1068034 For Flex Connection 	84153 (Pump) 	Various seats, see KOHLER.com/ServiceParts
Call Technical Support 800-4KOHLER			
1007489 	84153 (Pump) 	K-4612*	N/A
Call Technical Support 800-4KOHLER			
N/A	N/A	1183995*	1196212* (Glass Panels)
N/A	N/A	1214139*	1214142* (Glass Panels)
Call Technical Support 800-4KOHLER			











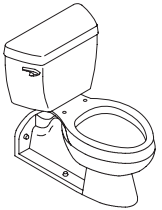
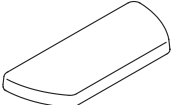

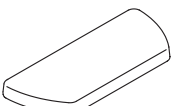

Numi/Power Lite®  
One-Piece Toilets

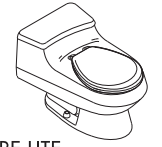
Note: Part numbers that have a "GP" prefix refer to a blister package.  
For example, GP1059291 is the same part as previous part number 1059291 but in a blister package.

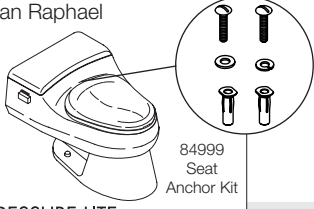
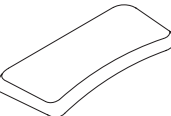

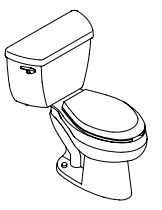
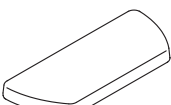



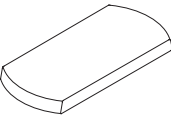
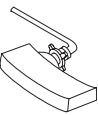

# Pressure Lite® One- and Two-Piece Toilets

## Toilet

## Toilet Details

Product Name	Model Number	Tank Cover	Trip Lever
Barrington™  K-3652 Tank: K-4484 PRESSURE LITE. <small>KOHLER</small>		1036375* 	1045276* LH  1045277* RH 
Call Technical Support 800-4KOHLER			
Highline®  K-3493, K-3554 Tank: K-4645 K-3519, K-3531 Tank: K-4484 PRESSURE LITE. <small>KOHLER</small>		1036375* 	1045276* LH  1045277* RH 
Call Technical Support 800-4KOHLER			
Rialto®  Discontinued K-3404 PRESSURE LITE. <small>KOHLER</small>		Discontinued	Discontinued
Call Technical Support 800-4KOHLER			
San Raphael®  Discontinued K-3394 PRESSURE LITE. <small>KOHLER</small>		Discontinued	Discontinued
Call Technical Support 800-4KOHLER			
San Raphael  84999 Seat Anchor Kit K-3393 K-3597 K-3607 PRESSURE LITE. <small>KOHLER</small>		1055954* 	1089001* 
Call Technical Support 800-4KOHLER			
Wellworth®  K-3505 Tank: K-4645 PRESSURE LITE. <small>KOHLER</small>		1036375* 	1045276* LH  1045277* RH 
Call Technical Support 800-4KOHLER			
Wellworth, Highline, Barrington  K-3458, K-3544, K-3546 Tank: K-4470 PRESSURE LITE. <small>KOHLER</small>		81449* 	84874* 
Call Technical Support 800-4KOHLER			

Pressure Lite® One- and Two-Piece Toilets  
**KOHLER®** Genuine Parts

Float/Fill Valve	Flush Valve	Seat	Flush Ball/Flapper
N/A	N/A	84460  GP52050 	N/A
Call Technical Support 800-4KOHLER			
N/A	N/A	GP51487 	N/A
Call Technical Support 800-4KOHLER			
N/A	N/A	N/A	N/A
Call Technical Support 800-4KOHLER			
N/A	N/A	N/A	N/A
Call Technical Support 800-4KOHLER			
N/A	N/A	1104621 	N/A
Call Technical Support 800-4KOHLER			
N/A	N/A	84460  GP52050 	N/A
Call Technical Support 800-4KOHLER			
N/A	N/A	1037307  GP52050 	N/A
Call Technical Support 800-4KOHLER			













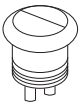

Pressure Lite®  
 One- and Two-Piece Toilets

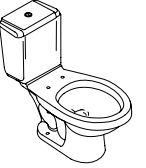
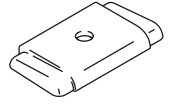
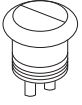
Note: Part numbers that have a "GP" prefix refer to a blister package.  
 For example, GP1059291 is the same part as previous part number 1059291 but in a blister package.

Toilet

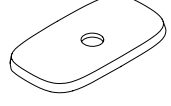
Toilet Details

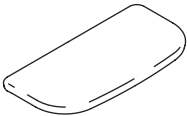









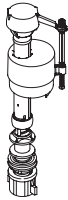

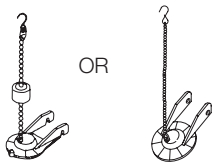
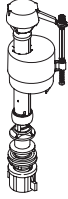



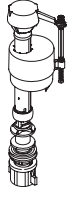
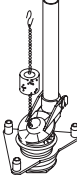

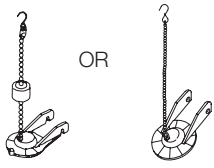
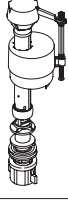
STERLING Toilets

Product Name	Model Number	Tank Cover	Trip Lever										
Cordova™ 	402020 402220 Tank: 404520	Discontinued	Discontinued										
Karsten® 	402025, 402087, 402028 Tank: 402023	1040340* 	1036156* 										
Riverton™ 	<table border="0"> <tr> <td><b>1.28 GPF</b></td> <td><b>1.6 GPF</b></td> </tr> <tr> <td>402083</td> <td>402502</td> </tr> <tr> <td>402084</td> <td>402522</td> </tr> <tr> <td>402085</td> <td>402532</td> </tr> <tr> <td>404701</td> <td></td> </tr> </table> Tank: 404552	<b>1.28 GPF</b>	<b>1.6 GPF</b>	402083	402502	402084	402522	402085	402532	404701		84624* 	84625-CP (Chrome) 1166878-0 (White) 85086-VF (Brass) 
<b>1.28 GPF</b>	<b>1.6 GPF</b>												
402083	402502												
402084	402522												
402085	402532												
404701													
Rockton® 	402024, 402027, 402088 Tank: 402022	1045794* 	1036156* 										
Stanton™ 	402211, 402209 Tank: 402092	1226567* 	84625* 										
Stanton Dual Flush 	402212, 402213 Tank: 402093	1227743* 	1240532* 										
Stinson® 	<table border="0"> <tr> <td><b>1.28 GPF</b></td> <td><b>1.6 GPF</b></td> </tr> <tr> <td>402076</td> <td>402075</td> </tr> <tr> <td>402077</td> <td>402375</td> </tr> <tr> <td>404702</td> <td>Tank: 402071</td> </tr> </table> Tank: 402091	<b>1.28 GPF</b>	<b>1.6 GPF</b>	402076	402075	402077	402375	404702	Tank: 402071	1068490* 	1185068* 		
<b>1.28 GPF</b>	<b>1.6 GPF</b>												
402076	402075												
402077	402375												
404702	Tank: 402071												

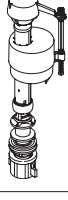
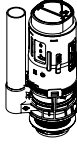

STERLING® Toilets  
KOHLER® Genuine Parts

STERLING Toilets

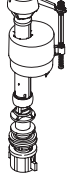
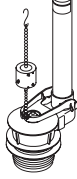
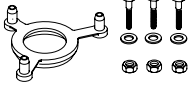
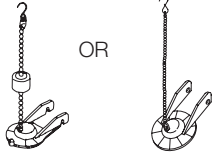



Float/Fill Valve	Flush Valve	Tank Gasket	Flush Ball/Flapper
<p>GP1138930</p> 	N/A	<p>GP51487</p> 	<p>GP1105825 1.28 GPF OR GP87449 1.6 GPF</p> 
<p>GP1138930</p> 	<p>1072320</p> 	<p>1032265</p> 	<p>1131496</p> 
<p>Service with GP1138930</p> 	<p>84910 (1.6 GPF) 1110262 (1.28 GPF)</p> 	<p>GP51487</p> 	<p>GP1105825 1.28 GPF OR GP87449 1.6 GPF</p> 
<p>GP1138930</p> 	<p>1072320</p> 	<p>1032265</p> 	<p>1131496</p> 
<p>GP1138930</p> 	<p>1247135</p> 	<p>GP51487</p> 	<p>GP87449</p> 
<p>GP1138930</p> 	<p>1247136</p> 	<p>GP51487</p> 	N/A
<p>Service with GP1138930</p> 	<p>1110262</p> 	<p>GP51487</p> 	<p>GP1105825 1.28 GPF OR GP87449 1.6 GPF</p> 

Note: Part numbers that have a "GP" prefix refer to a blister package.  
For example, GP1059291 is the same part as previous part number 1059291 but in a blister package.





Toilet

Toilet Details

STERLING Toilets

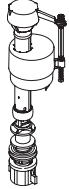
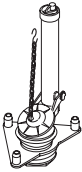
Product Name	Model Number	Tank Cover	Trip Lever						
Windham™ 	<table border="0"> <tr> <td><b>1.28 GPF</b></td> <td><b>1.6 GPF</b></td> </tr> <tr> <td>402080, 402081, 402082, 404700 Tank: 404555</td> <td>402015, 402215, 402315 Tank: 404515</td> </tr> <tr> <td>402078, 402079 Tank: 404544</td> <td>402014, 402214, 402315 Tank: 404514</td> </tr> </table>	<b>1.28 GPF</b>	<b>1.6 GPF</b>	402080, 402081, 402082, 404700 Tank: 404555	402015, 402215, 402315 Tank: 404515	402078, 402079 Tank: 404544	402014, 402214, 402315 Tank: 404514	84537* 	84625-CP (Chrome) 1166878-0 (White) 85086-VF (Brass) 
<b>1.28 GPF</b>	<b>1.6 GPF</b>								
402080, 402081, 402082, 404700 Tank: 404555	402015, 402215, 402315 Tank: 404515								
402078, 402079 Tank: 404544	402014, 402214, 402315 Tank: 404514								
Windham™ 	403080 403081 403082 404705 Tank: 404551	1203861*	84625-CP (Chrome) 1166878-0 (White) 85086-VF (Brass) 						

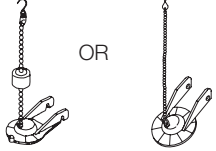
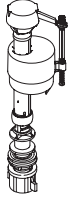
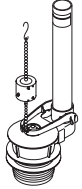
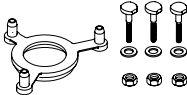
STERLING® Toilets  
 KOHLER® Genuine Parts

Float/Fill Valve	Flush Valve	Tank Gasket	Flush Ball/Flapper
Service with GP1138930 	85073 	GP51487 	GP1105825 1.28 GPF GP87449 1.6 GPF OR 
GP1212894 	1212845 	GP51487 	GP1105825 1.28 GPF 

STERLING Toilets

Note: Part numbers that have a “GP” prefix refer to a blister package.  
 For example, GP1059291 is the same part as previous part number 1059291 but in a blister package.



Scan to download this catalog for your convenience.

Kohler Co. reserves the right to make changes in product characteristics, packaging or availability at any time without notice. Every effort has been made to ensure the correct part numbers are listed in this matrix.

**Unable to locate a part?**

If you have identified the parts you need, call **800-4-KOHLER** (800-456-4537), Monday-Friday, between 8am and 6pm CST, and a Customer Service representative will assist you. Or visit **KOHLER.com/ServiceParts**.

Form 10-1099-0315  
© 2015 by Kohler Co.  
Kohler, Wisconsin 53044  
Printed in U.S.A.  
1-800-4-KOHLER  
(1-800-456-4537)

**KOHLER**.com