

ROUGHING-IN 产品尺寸图 (Unit:mm) (单位: 毫米)

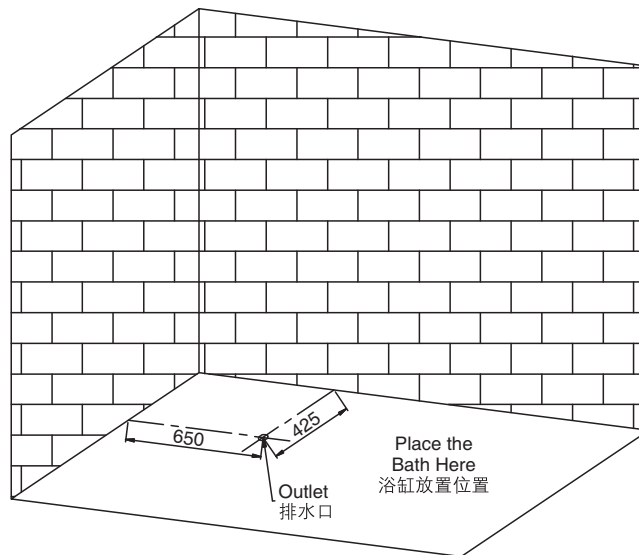

K-24459T
 Three-dimension installation roughing-in
 左角位立体安装尺寸图

The actual outlet should be located in the area centering the shown outlet and extending with the radius 250mm.
 排水口应位于以图示排水口为中心, 半径为250mm的范围内。

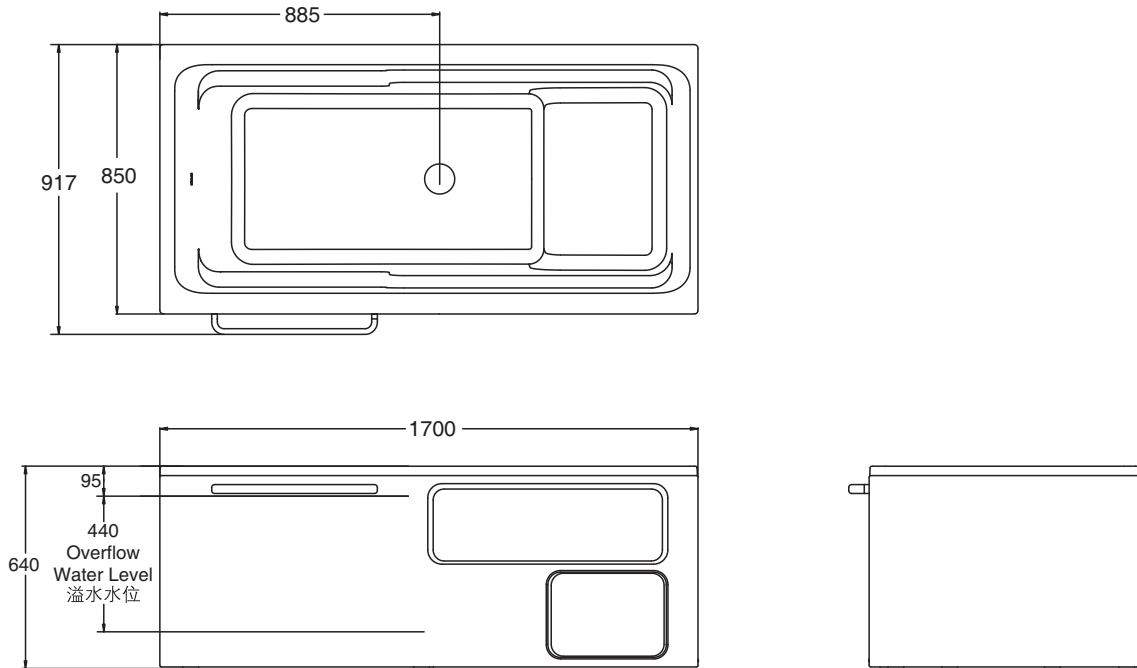
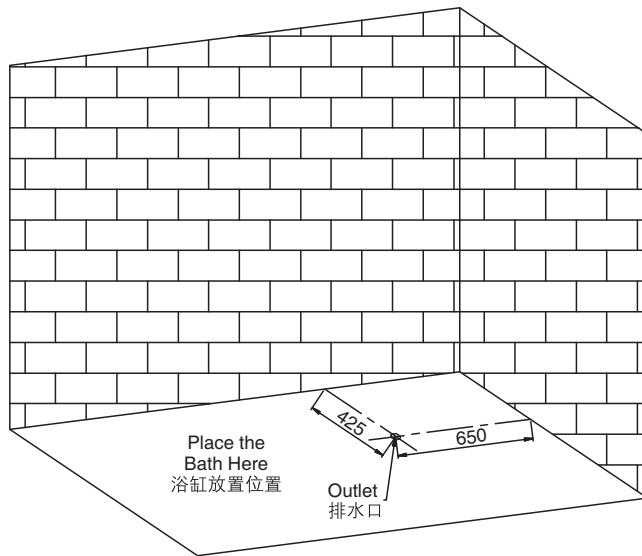
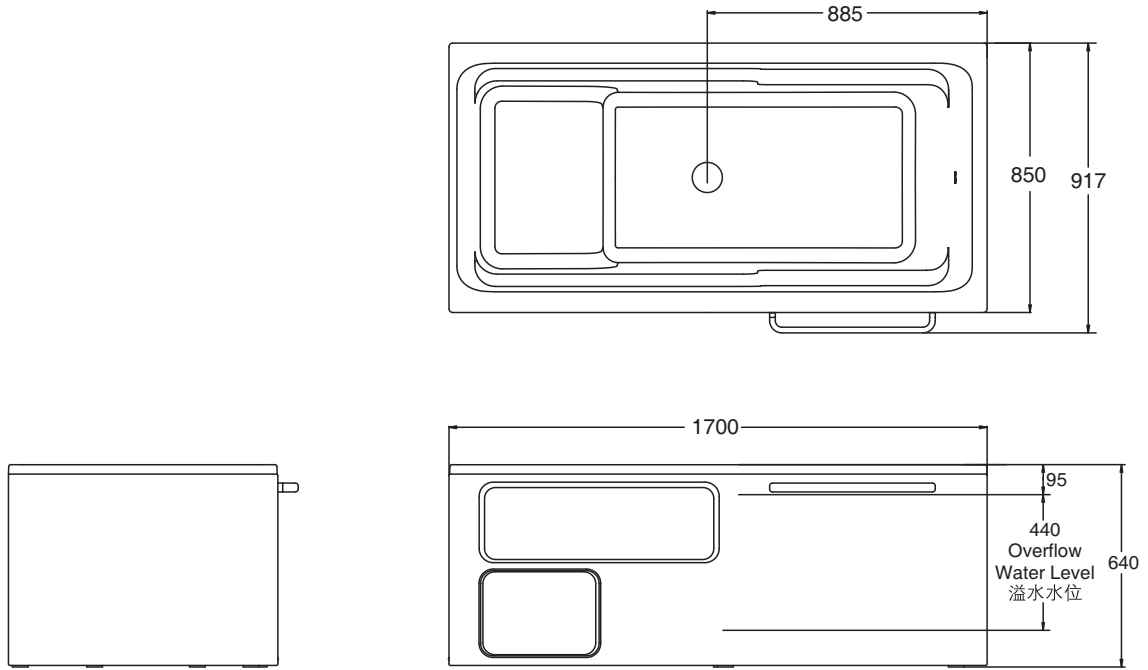

The actual outlet should be located in the area centering the shown outlet and extending with the radius 250mm.
排水口应位于以图示排水口为中心，半径为250mm的范围内。

K-24460T
Three-dimension installation roughing-in
直角位立体安装尺寸图

PRODUCT INFORMATION 产品信息

Water Depth 深度 (To Overflow Hole Bottom 至溢水口底部)	440mm (毫米)
Capacity 水容量 (To Overflow Hole Bottom 至溢水口底部)	290L (升)
Basin Area 底部面积	987mm (毫米) × 576mm (毫米)
Top Area 顶部面积	1575mm (毫米) × 690mm (毫米)

Installation Notes 安装要点

- Refer to installation instruction included with fixture before beginning installation.
- 开始安装前请参考浴缸包装中的安装说明书。
- Unless otherwise specified floor support under bath must provide for a minimum of 500kg loading (including the weight of bathtub, water and one user).
- 除非另有说明，否则浴缸下地面必须至少可以承载500kg的负载(包含浴缸、水及一名使用者的重量)。

Included Accessory Information 包含配件信息

Bath Drain 浴缸排水.....K-18355T-CP
Basin Assy 小浴盆组件1338103

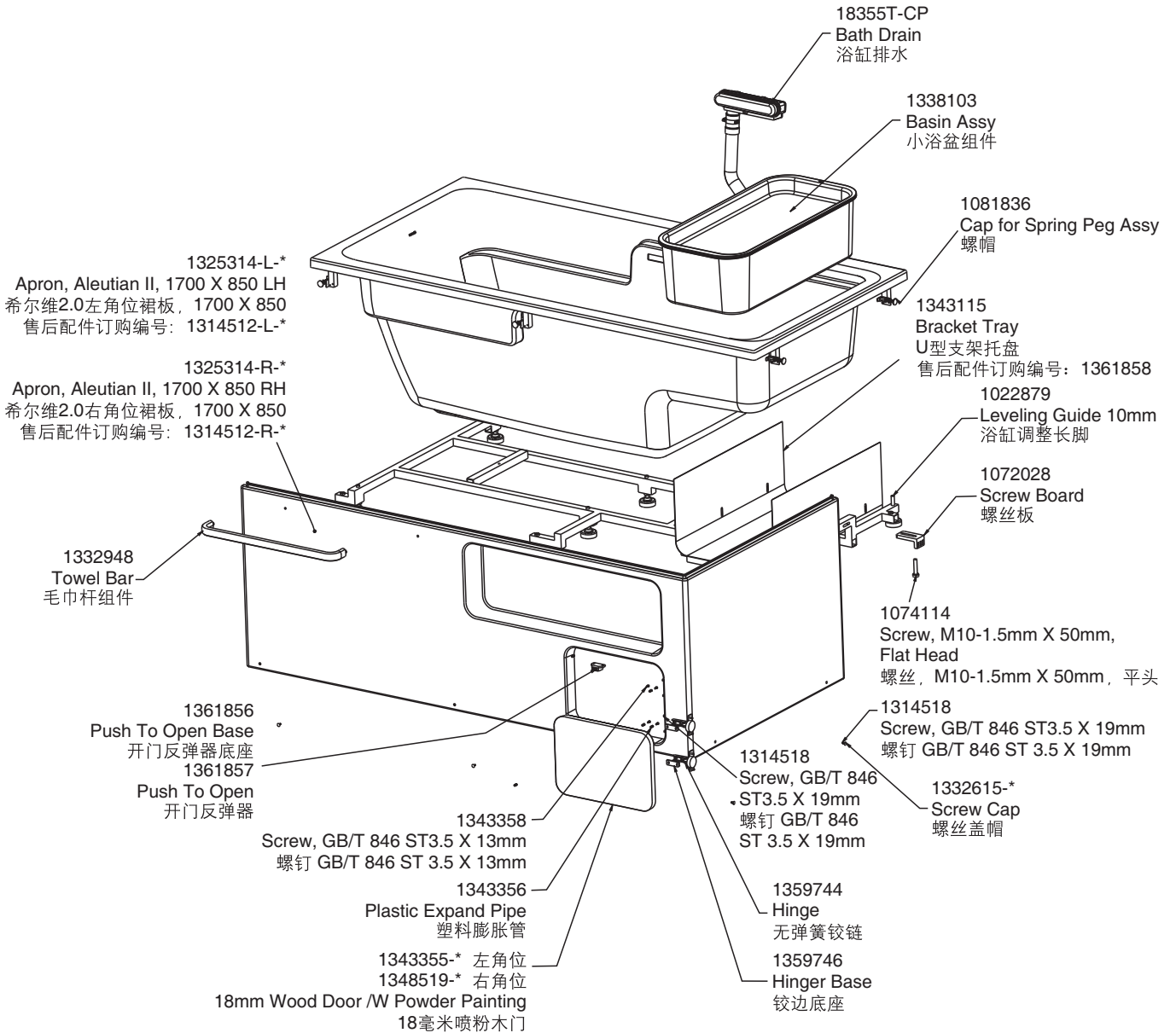

* Color code must be specified when ordering

* 订货时必须指明颜色代码