

### Features

- 33-inch minimum base cabinet width for top-mount installation.
- 36-inch minimum base cabinet width for under-mount installation.
- Acid-resistant enamel finish.
- Top-mount or under-mount.
- Double (small/large) compartment.
- Reversible.
- Smart Divide® lowered bowl divider.
- 33" (838 mm) x 18-3/4" (476 mm)

### Material

- KOHLER® enameled cast iron.

### Recommended Accessories

K-9000 P-Trap  
 K-5137 Sink Rack  
 K-6377 Sponge Caddy  
 K-6378 Kitchen Brush Caddy  
 K-6379 Kitchen Squeegee  
 K-6382 Disinfecting Wipes Dispenser  
 K-6383 Soap Dispenser  
 K-8618 Paper Towel Holder  
 K-8619 Flexible Kitchen Mat  
 K-8624 Dish Scraper  
 K-5139 Sink Rack

### Optional Accessories

K-8801 Sink Strainer  
 K-5180 Right-Bowl Sink Rack

### Components

Product includes:  
 1054375 Under-mount Sink Kit, 23"



### Codes/Standards

















ASME A112.19.1/CSA B45.2

### KOHLER® Enameled Cast Iron Kitchen Sink Lifetime Limited Warranty

See website for detailed warranty information.

### Available Color/Finishes

*Color tiles intended for reference only.*

Color	Code	Description
	0	White
	FF	Sea Salt™
	96	Biscuit
	47	Almond
	FD	Cane Sugar™
	NY	Dune
	95	Ice™ Grey
	G9	Sandbar
	33	Mexican Sand™
	K4	Cashmere
	FT	Basalt
	58	Thunder™ Grey
	20	Suede
	KA	Black 'n Tan
	FP	Caviar
	7	Black Black™

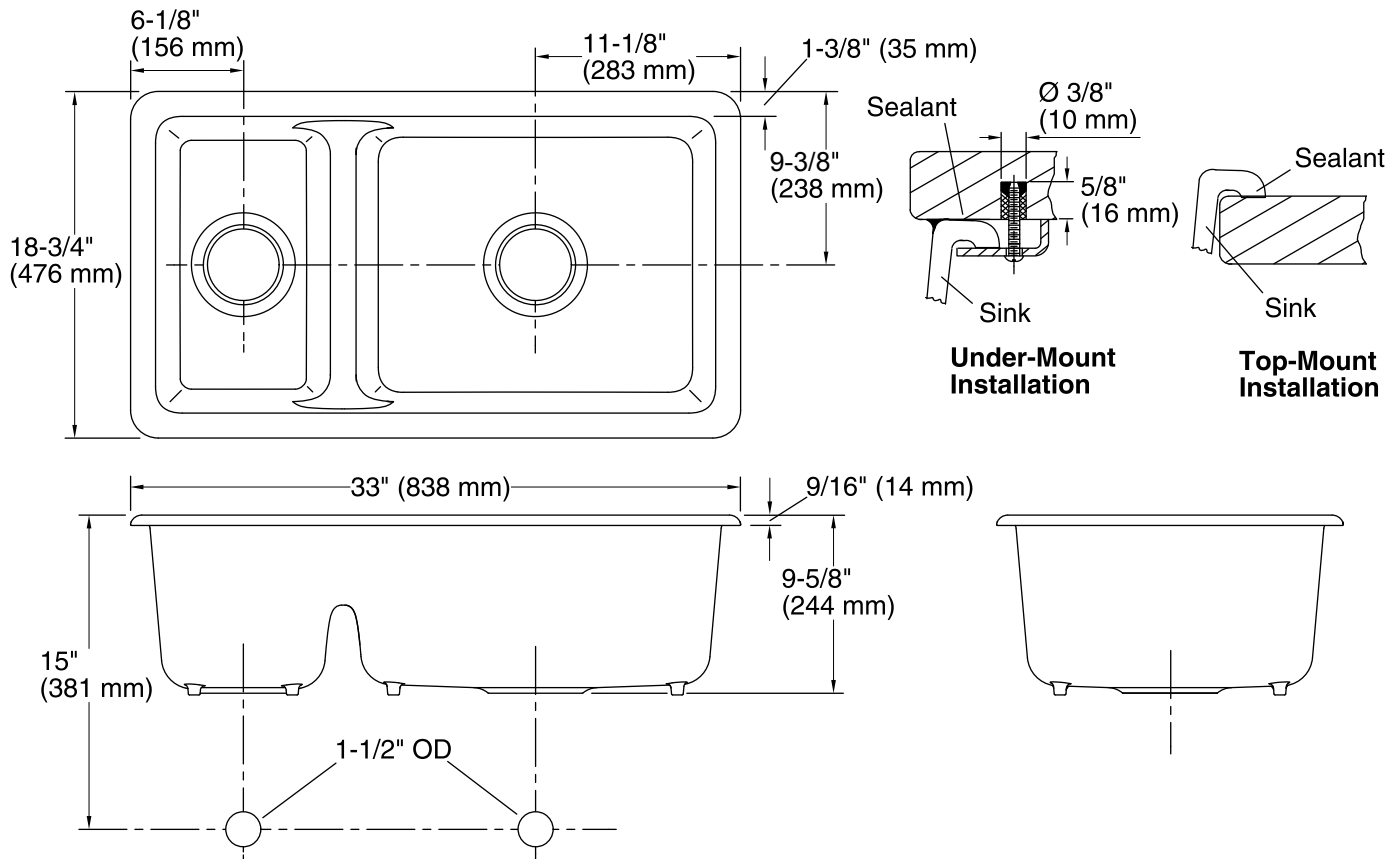

### Technical Information

All product dimensions are nominal.

Bowl configuration:	Offset Large/small
Installation:	Top-mount, Under-mount
Bowl area (Right):	Length: 19-1/4" (489 mm) Width: 16" (406 mm) Water depth: 9" (229 mm)
Bowl area (Left):	Length: 9-1/4" (235 mm) Width: 16" (406 mm) Water depth: 9" (229 mm)
Drain hole:	3-7/8" (98 mm)
Template:	1043168-7, required, included

### Notes

Install this product according to the installation instructions.

**NOTICE:** The countertop manufacturer or cutter must use the cut-out template provided with the product, or a current one provided by the Kohler Co. (Call 1-800-4-KOHLER.) Kohler Co. is not responsible for cut-out errors when the incorrect cut-out template is used.