

科勒 THE BOLD LOOK OF KOHLER 全球厨卫经典

K-2075T-1/-4/-8 史瑞夫 SERIF

釉面陶瓷修边式台上脸盆
VITREOUS CHINA SELF-RIMMING LAVATORY
切割图/安装说明书
CUT-OUT TEMPLATE / INSTALLATION INSTRUCTION

安装之前

- 留意当地所有给排水及建筑规定。
- 检查排水管及供水管。如有需要请更换。
- 安装之前，先开启新脸盆的包装，并小心检查新的脸盆是否有损坏，再将新的脸盆放回包装箱内，到安装时才取出。
- 若为更换新脸盆，须确保现有的柜台孔口与新脸盆的切割位相同或者较后者小。
- 请使用同时印在此说明书上的安装模板。
- 如果脸盆已经随附密封胶，请不要使用其它的密封胶。
- 如果可能的话，在安装脸盆之前组装脸盆上的水龙头和排水管。

建议工具及材料

- 安装模板(已提供)
- 护眼镜
- 软性铅笔
- 卷尺
- 涂油灰刀
- 戳孔线锯或者手提电锯
- 密封胶(可能提供)
- 剪刀
- 切管刀
- 钻头直径为13毫米或更大的钻
- 活动扳钳
- 喉管扳钳
- 钢锯

BEFORE YOU BEGIN

- Observe all local plumbing and building codes.
- Inspect the drainage and supply tubing; Replace if necessary.
- Prior to installation, unpack the new lavatory and carefully inspect it for damage. Return the lavatory to its protective carton until you are ready to install it.
- For replacement installations, make sure the existing cutout is the same or smaller size as the new lavatory.
- Use the template supplied with the lavatory.
- Do not substitute another sealant if one is supplied with this lavatory.
- If possible, assemble the faucet and drain to the lavatory before installing the lavatory.

RECOMMENDED TOOLS AND MATERIALS

- Template(supplied)
- Safety Glasses
- Pencil
- Tape Measure
- Putty Knife
- Keyhole Saw or Saber Saw
- Sealant (may be supplied)
- Scissors
- Pipe Wrench
- Drill With 1/2" (13mm) Or Larger Drill Bit
- Adjustable Wrench
- Tubing Cutter
- Hacksaw

产品信息

器具*	面盆区域	面盆深度
脸盆	430mm x 278mm	158mm
排水口	直径44mm	
* 仅为大致尺寸，仅用于型号对比。		
孔	K-2075T-8	K-2075T-4
出水嘴	直径30mm	直径30mm
水龙头	直径35mm	直径30mm

Product Information

Fixture*	Basin Area	Basin Depth
Lavatory	430mm x 278mm	158mm
Outlet	D. 44mm	
* Approximate Measurements For Comparison Only.		
Holes	K-2075T-8	K-2075T-4
Spout	D. 30mm	D. 30mm
Faucet	D. 35mm	D. 30mm

拆除旧脸盆

- 关掉水龙头的供水源。
- 打开水龙头阀门，然后拆下供水管。
- 拆下排水组件存水弯。
- 移走旧脸盆。

安装新脸盆

- 将切割模板沿切割线切出。
- 将切割模板放在盥洗台上，确保脸盆、水龙头和防撞档板之间有足够的空间。检查台面下的储物柜有足够的空间。

- 用炭笔沿切割模板在盥洗台面上划线。
- 检查脸盆、水龙头、防撞档板和储物柜间的距离，如有需要，可调整切割模板的位置。

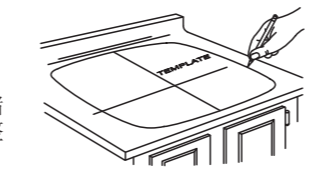
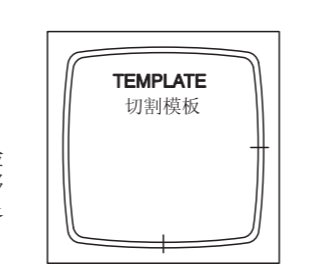
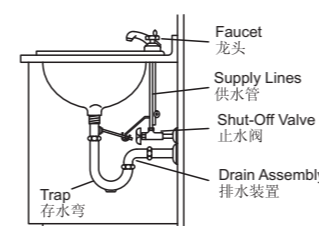

REMOVE EXISTING LAVATORY

- Turn off the water supply to the faucet.
- Open the faucet valves, then disconnect the supply lines.
- Disconnect the drain assembly and remove the trap.
- Remove the existing lavatory.

INSTALL NEW LAVATORY

- Cut the template on the cutout line.
- Position the template on the countertop to ensure clearance between the lavatory, faucet, and backsplash. Verify cabinet clearance beneath the countertop.

- Trace the template on the countertop with a pencil.
- Check the clearance between the lavatory, faucet, backsplash, and cabinet. Readjust the template.

- 用一个13毫米的钻头，在切割口的内侧钻出一个导孔。
- 沿着自切割模板勾画出来的炭笔划线的内侧，切开台面。

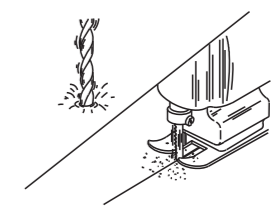

- 小心：提防身体受伤或者损坏产品。因大型脸盆相当重，需要找人帮助您一起搬动及安放。

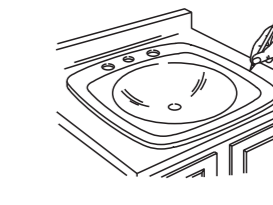

- 暂时将脸盆放入台面开口，校正位置。
- 用炭笔沿脸盆外缘在盥洗台上划线。
- 然后将脸盆移开。

如果水龙头和排水管还未安装，请在此时安装。一定要遵循产品包装上的所有使用说明。

- Drill a 1/2" (13mm) hole on the inside of the outline.
- Cut the opening in the countertop along the inside edge of the pencil line.

- CAUTION: Risk of personal injury or product damage. Large lavatories are very heavy! Get help lifting the lavatory into place.
- Temporarily position the lavatory in the opening, and adjust to fit.
- Trace a pencil line around the outside edge of the lavatory.
- Remove the lavatory.

IF THE FAUCET AND DRAIN ARE NOT INSTALLED, INSTALL THEM AT THIS TIME. BE SURE TO FOLLOW ALL INSTRUCTIONS PACKED WITH THE PRODUCT.

- 沿炭笔导线内侧涂两条密封胶。
- 用涂油灰刀将其抹匀。

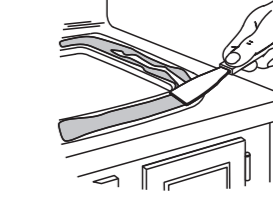

- 小心：提防身体受伤或者损坏产品。因大型脸盆相当重，需要找人帮助您一起搬动及安放。

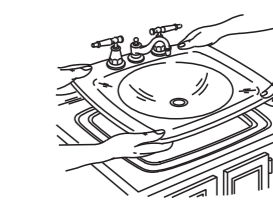

- 小心地将脸盆置于台面切口适当位置，向下按平。

- CAUTION: Risk of personal injury or product damage. Large lavatories are very heavy! Get help lifting the lavatory into place.
- Carefully position the lavatory in the cutout, and press down firmly.

- 立即擦去多余的密封胶。如脸盆外缘与台面之间有缝隙，即用胶填满。
- 检查脸盆的位置正确。
- 最少待三十分，让密封胶干透后，方可继续进行安装。

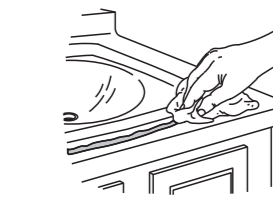

连接供水

- 连接排水装置。
- 连接水龙头供水管并且完成水龙头安装。一定要遵循水龙头包装上的所有使用说明。

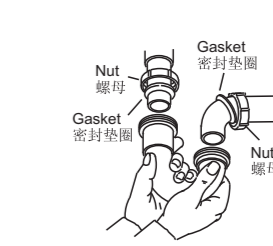

CONNECT SUPPLIES

- Connect the drain assembly.
- Connect the faucet supply lines and complete the faucet installation. Be sure to follow all instructions packed with the faucet.

用户须知(护理和清洁)

为保持脸盆光洁如新，须确保每次使用后彻底冲洗干净，切勿使用腐蚀性的清洁剂，以免刮花及破坏脸盆的表面。要清除顽固污垢，油漆或油污，可使用松油或油漆稀释剂。

IMPORTANT CONSUMER INFORMATION (CARE AND CLEANING)

To keep your lavatory looking new, make sure you rinse it out thoroughly after each use. DO NOT USE ABRASIVES on this product, as they will scratch and ruin the surface. Stubborn stains, paint, or tar can be removed with turpentine or paint thinner.

陶瓷及浴缸产品及配件担保——一年有限担保

科勒公司担保其陶瓷及浴缸产品及配件在制造工艺上无瑕疵。

Plumbing Fixtures and Fittings Limited One-year Warranty

Kohler plumbing fixtures and fittings are warranted to be free of manufacturing defects.

本产品自购买之日起即获得本公司一年的质量保证。在质保期内，凭购货发票，科勒公司将免费承担由制造质量问题引起的任何问题。经核查后，科勒中国有限公司有权决定是修理、更换、还是作适当的调整。

This product is warranted for one year from date of purchase. Kohler China will be responsible for any problems caused by manufacturing defects provided with the invoice. Kohler China will, at its election, repair, replace or make appropriate adjustment where Kohler China inspection discloses any such defects occurring in normal usage within one year after purchase.

这里所指的担保，包括产品，都已明确地限制在该担保期之内。科勒中国有限公司对其后出现的损坏不负有任何责任。担保也不包括外观损伤、使用不当以及未按说明书安装的损失。

Implied warranties including that of merchantability and fitness for a particular purpose are expressly limited in duration to the duration of this warranty. Kohler China disclaims any liability for special, incidental or consequential damages. Damages to the product caused by misuse, abuse and installation that is not in accordance with the owner's manual are not covered by this warranty.

为获得快捷的担保服务，请联系您的销售商；您也可写信给科勒中国有限公司(请出示销售发票原件作为购货凭证)：

To obtain quick warranty service, please contact your dealer, or write to Kohler China. (Original sales receipt must be provided as the proof of purchase.)

科勒(中国)投资有限公司
中央客户服务中心
上海市卢湾区淮海中路138号
上海广场19楼
邮编：200021

Kohler China Investment Company Ltd.
Central Customer Service Center
19/F, Shanghai Square, 138 Huai Hai Road,
Luwang District, Shanghai, PRC
Zip Code: 200021

这是我们全部的书面担保。

This is our exclusive written warranty.

在画出模板的全部尺寸时：确保水平和垂直尺寸与模板上标注的尺寸相符。WHEN PLOTTING TEMPLATE FULL SIZE: make sure horizontal and vertical dimensions match the dimensions labeled on the template.

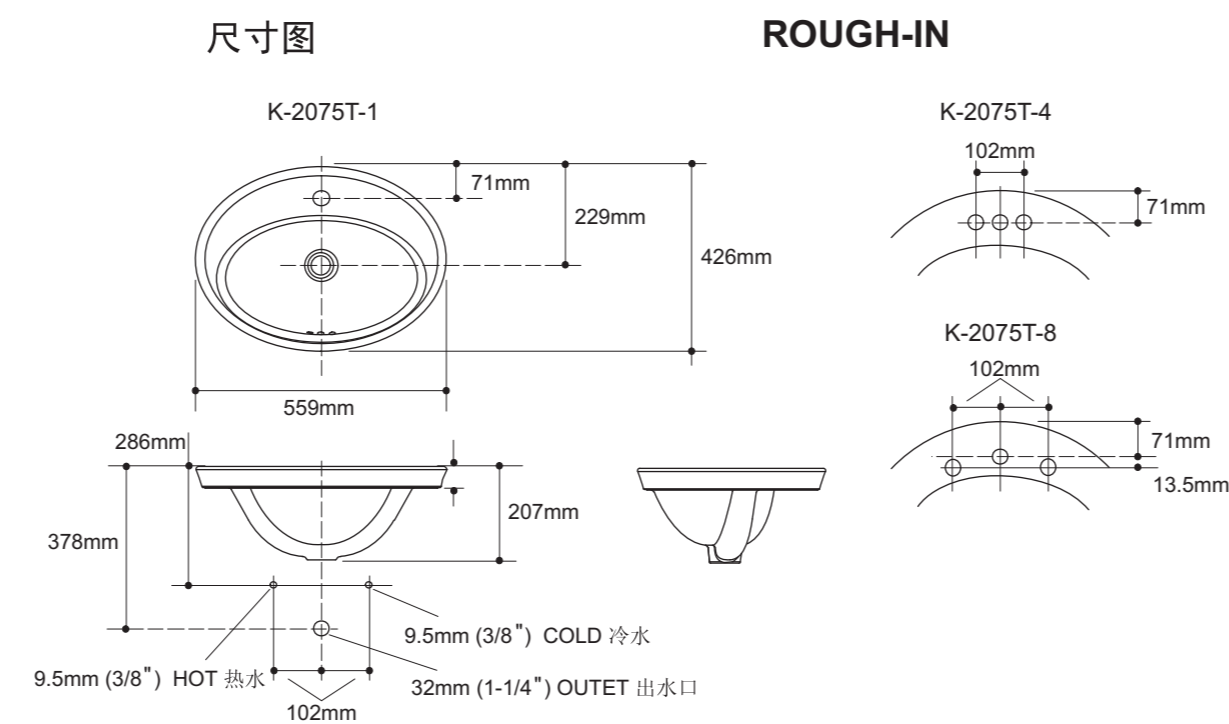

沿此线切割
CUT ALONG THIS LINE

脸盆边缘
RIM OF LAVATORY

1041885-T01-A

© 版权为科勒中国有限公司所有，2004
© Copyright Kohler China Ltd., 2004