

**ROUGHING-IN 产品尺寸图** (Unit:mm) (单位: 毫米)

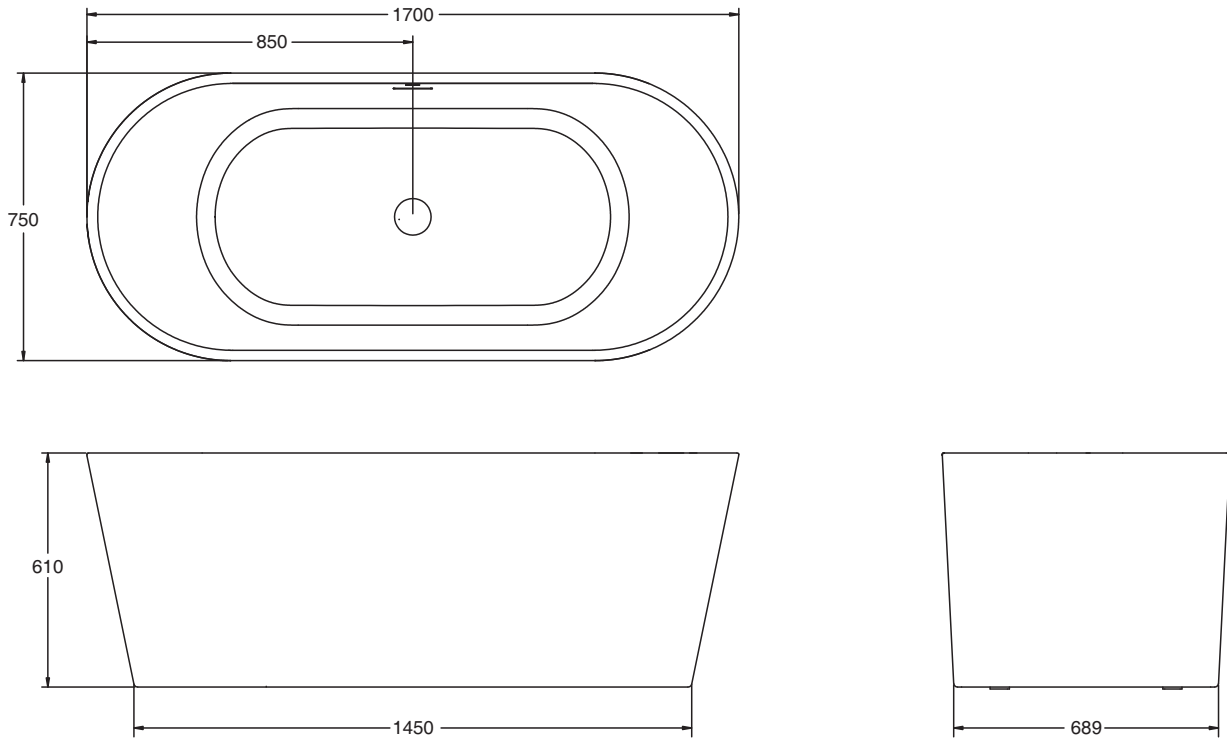

**PRODUCT INFORMATION 产品信息**

Water Depth 深度 (To Overflow Hole Bottom 至溢水口底部)	410mm (毫米)
Capacity 水容量 (To Overflow Hole Bottom 至溢水口底部)	284L (升)
Basin area 底部面积	1127mm (毫米) × 564mm (毫米)
Top area 顶部面积	1642mm (毫米) × 695mm (毫米)

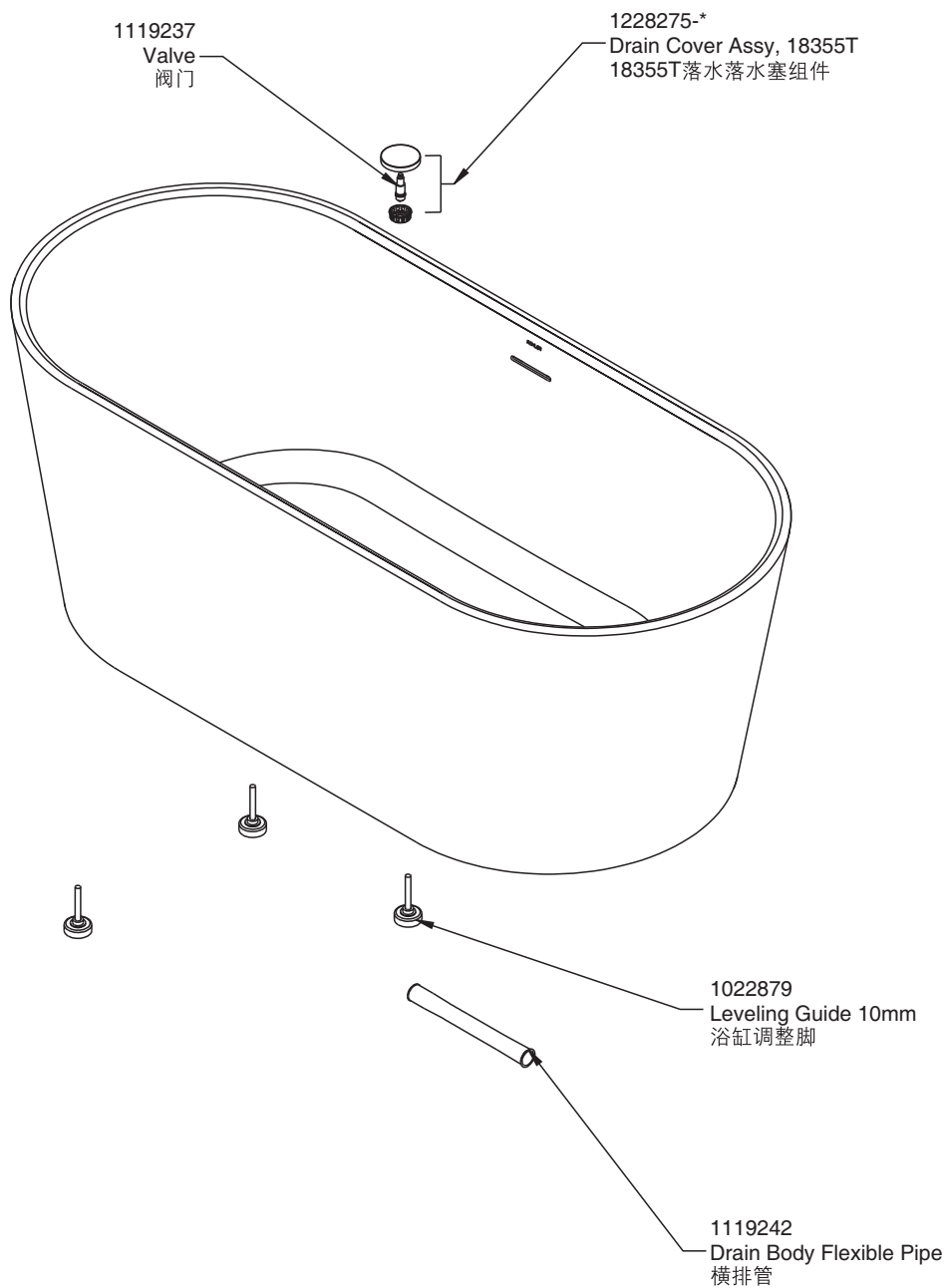

\* Color code must be specified when ordering.

\* 订货时必须指明表面处理/颜色代码