



Model AC789

**Model AC789****Length:** 72" (1829 mm)**Width:** 42" (1067 mm)**Height:** 20" (508 mm)**Shipping Weight:** 130 lbs. (59 Kg)**Water to Overflow:** 90 gallons (341 Litres)**Minimum Water Capacity:** 60 gallons (227 Litres)**Materials:** Manufactured from a one-piece acrylic sheet, reinforced with fibreglass.

The Donbrook's minimalist design with tight radii and sweeping armrests provides extra space for taller bathers. The deck provides ample space for faucet installation.

**Standard Features:**

- Easy to clean high gloss surface
- Chip and mar resistant
- Moulded-in floor pattern

**Options:**

- Flange kits for attaching bath to walls

**Colours:**

- Standard: White, Almond (Bone) or Biscuit
- Optional: Kohler Colours

**Other Configurations:**

- Whirlpool (LCMJ6/RCMJ6)
- Enhanced whirlpool (PE)
- Enhanced whirlpool w/heater (PEH)
- Enhanced whirlpool w/chromatherapy (PECE)
- Enhanced whirlpool w/heater & chromatherapy (PEHCE)
- BubbleAir™ air jets (BT)
- BubbleAir air jets w/chromatherapy (BTCE)

All products manufactured by Hytec are covered by a comprehensive five-year limited warranty from the date of sale to the original owner. See the Hytec Bathing Fixtures List Price Book for further details.

**Hytec Plumbing Products**

(Division of Kohler Canada Co.)

4150 Spallumcheen Dr, Armstrong BC V0E 1B6

Ph. (800) 871-8311 (250) 546-3196 Fax (250) 546-3170

Model AC789

ACRYLIC

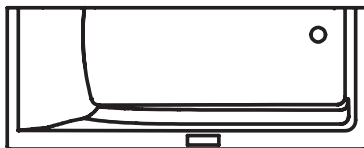
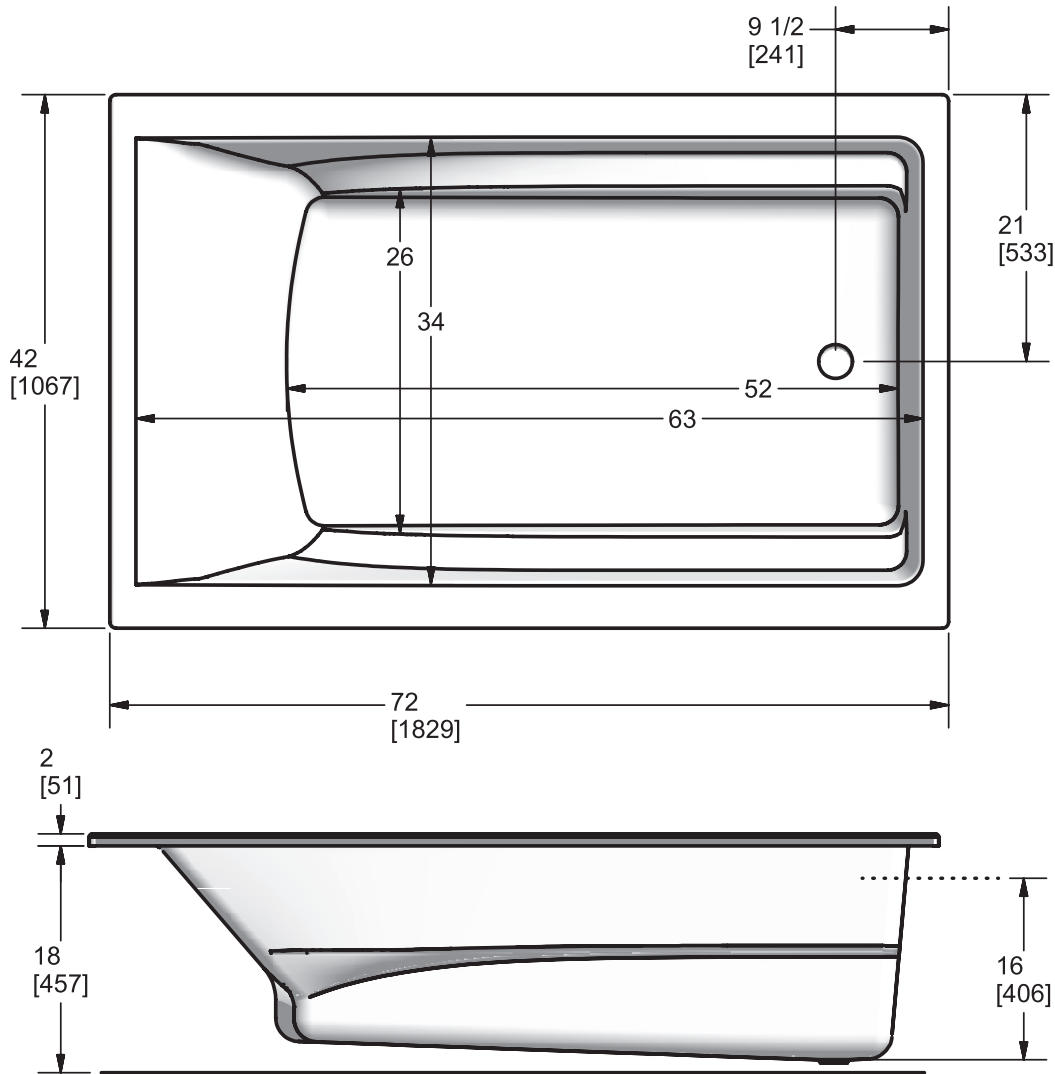

Keypad Location  
 Size: 5.75" X 1.75"  
 Centred on Side Deck  
 (Keypad available when paired  
 with Enhanced Bathing Options)

Measurement tolerances  $\pm 1/4"$  (6.3 mm)

All bathing fixtures comply with the applicable Canadian Standards.

For installation procedures, please refer to instructions included with each unit.

This sheet approximately describes products and equipment manufactured or supplied by Hytec Plumbing Products. Because of ongoing efforts to improve both design and quality, products and equipment actually furnished may differ without prior notice.



**Hytec Plumbing Products**  
 (Division of Kohler Canada Co.)  
 4150 Spallumcheen Dr, Armstrong BC V0E 1B6  
 Ph. (800) 871-8311 (250) 546-3196 Fax (250) 546-3170