

Features

- Column lets you customize your shower with a showerhead and handshower.
- Designed for new installations or retrofit to replace an existing installed shower arm.
- Patent-pending technology allows for an easy bath or shower installation.
- Diverter at the base of the column makes for easy toggling between the handshower and showerhead.
- Slidebar bracket allows you to adjust height and angle of the handshower.
- KOHLER finishes resist corrosion and tarnishing.
- Developed and optimized for use with KOHLER handshowers and KOHLER Katalyst™ showerheads.

Installation

- Wall-mount shower only installation.
- Installs in less than 60 minutes without changes to in-wall plumbing (subject to condition of existing installation).
- May require additional service parts based on installation type (see installation guide or specification sheet for details).
- Includes an adapter that will fit with most installations but may require one or more kits (sold separately).

Recommended Accessories

- 1187917 1/2" NPT Shallow Rough-in Kit
- 1194302 Large Escutcheon/Mounting Collar Kit
- 1194630 1/2" NPT Deep Rough-in Kit

Components

Additional included component/s: Column, Slidebar, and Bracket.

Installed component/s: Column/slidebar, and Handshower bracket.



ADA	CSA B651	OBC
-----	----------	-----

Codes/Standards





ASME A112.18.1/CSA B125.1
ADA
ICC/ANSI A117.1
CSA B651
OBC

KOHLER® Faucet Lifetime Limited Warranty

See website for detailed warranty information.

Available Color/Finishes

Color tiles intended for reference only.

Color	Code	Description
	CP	Polished Chrome
	SN	Vibrant® Polished Nickel
	BN	Vibrant® Brushed Nickel
	BV	Vibrant® Brushed Bronze
	2BZ	Oil-Rubbed Bronze

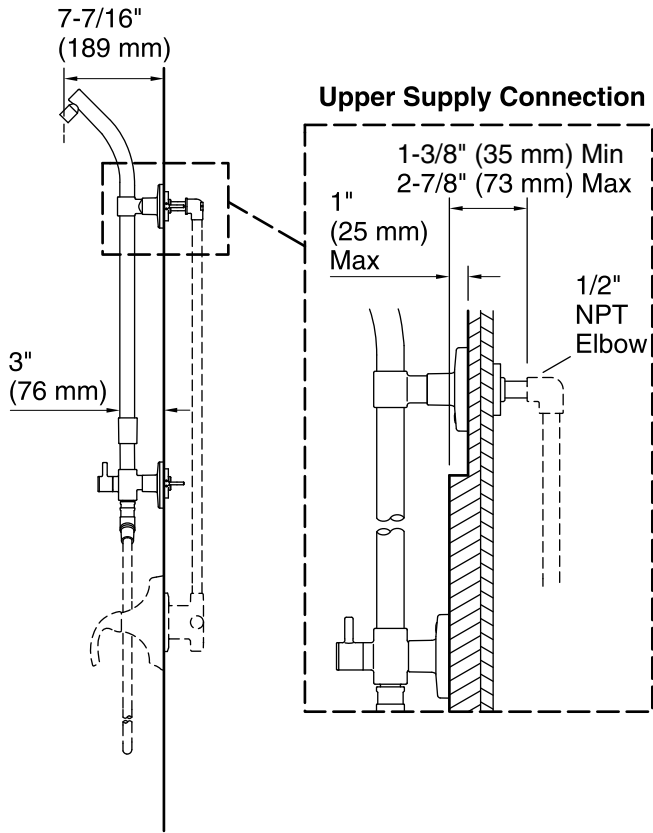
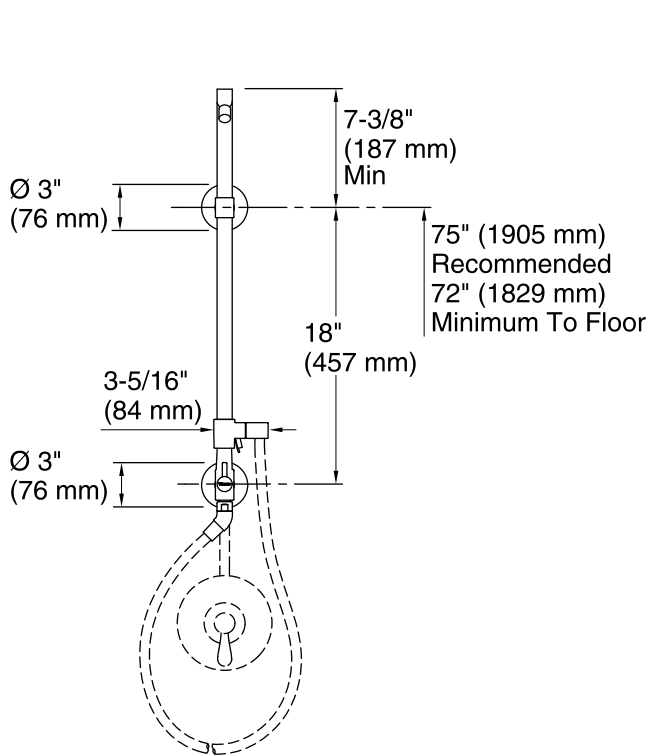

NOTE: Valve trim and hose illustrated for dimensioning only, not included in the product.

Technical Information

All product dimensions are nominal.

Notes

Install this product according to the installation guide.

Order deep roughing-in kit 1194630 if the distance from the elbow to the finished wall surface is between 2-7/8" (73 mm) to 4" (102 mm).

Order shallow roughing-in kit 1187917 if the distance from the elbow to the finished wall surface is less than 1-3/8" (35 mm).

A 3" (76 mm) escutcheon/mounting collar is supplied to fit a 1" (25 mm) to 1-1/4" (32 mm) supply connection hole diameter. Order 1194302 large escutcheon/mounting collar kit if the supply connection hole diameter is between 1-1/4" (32mm) to 2-1/4" (57 mm).

ADA, OBC, CSA B651 compliant when installed to the specific requirements of these regulations.