

BEFORE YOU BEGIN

- Please read these instructions carefully to familiarize yourself with the required tools, materials, and installation sequences. Follow the sections that pertain to your particular installation. This will help you avoid costly mistakes. In addition to proper installation, read all operating and safety instructions.
- All information in these instructions is based upon the latest product information available at the time of publication. Kohler China reserves the right to make changes in product characteristics, packaging, or availability at any time without notice.
- These instructions contain important care, cleaning, and warranty information - **please leave instructions for the consumer.**
- Observe all local plumbing and building codes.
- Carefully inspect the new urinal for damage.
- Site preparation may require additional tools and hardware.
- Fixture dimensions are nominal and conform to tolerances established by ASME Standards (A112.19.2-2018).
- The product complies with GB/T 6952-2015, GB 28377-2019.



CAUTION: Risk of personal injury or product damage. Handle with care. Vitreous china can break or chip if the product is handled carelessly.

安装之前

- 请通读本说明书，以便了解所需工具、材料及安装程序。请遵照相关章节进行安装，避免由于安装不当而导致不必要的损失。除了有关正确的安装方法之外，还务请详阅所有操作及安全说明。
- 本说明书所含一切资料，均以印刷时所有的最新产品为准，科勒中国保留随时更改产品特性、包装或供应情况的权利，恕不另行通知。
- 本说明书也包含了有关护理、清洁及保养等重要资料 - 请交予用户保存。
- 遵守当地所有给排水及建筑规定。
- 仔细检查新的小便器是否损坏。
- 准备场地可能要求附加工具和硬件。
- 部件尺寸为标定值，误差符合美国ASME标准(A112.19.2-2018)。
- 本产品符合GB/T 6952-2015、GB 28377-2019。



警告：可能有人身伤害或产品损坏的危险。小心处理，若有所马虎，陶瓷件可能碎裂。

ORDERING INFORMATION

MODERN LIFE FL Urinal (Rear) (1L/2.5L)K-21840T-2ER

订购资料

明莱落地式节水型小便器(后进水) (1L/2.5L).....K-21840T-2ER

RECOMMENDED TOOLS AND MATERIALS (NOT SUPPLIED)

- Open end/adjustable wrenches
- Tape measure
- Basin wrench
- Pipe wrench
- Square
- Level
- Pliers
- Socket wrench with sockets
- Screw driver
- Seal tape
- Connection wire
- Wire cutter
- Insulation tape
- Bushing
- Drill
- Sealant

所需工具及材料(不随货供应)

- 开口/活动扳钳
- 卷尺
- 梅花扳钳
- 管扳手
- 直角尺
- 水平尺
- 老虎钳
- 管钳子
- 十字螺丝刀
- 生料带
- 连接线
- 剥线器
- 绝缘胶布
- 电工套管
- 冲击钻
- 密封胶

No.2 KOHLER ROAD, SANSHUI CENTRAL INDUSTRIAL PARK, LEPING TOWN, SANSHUI DIST., FOSHAN, GUANGDONG, PRC POST CODE: 528137

广东省佛山市三水区乐平镇三水中心工业园区科勒大道2号 邮编: 528137

8# MENGSHAN RD, ECONOMIC DEVELOPMENT ZONE OF HUANTAI, ZIBO, SHANDONG, CHINA POST CODE: 256410

山东省淄博市桓台经济开发区蒙山路8号 邮编: 256410

NO.1 KOHLER STREET, ECONOMIC DEVELOPMENT ZONE OF FAKU COUNTY, SHENYANG LIAONING PROVINCE, PRC POST CODE: 110400

辽宁省沈阳市法库经济开发区科勒大街1号 邮编: 110400

ROUGHING-IN

尺寸图

* Recommended dimensions for installation only, please adjust according to actual situation.

*仅为建议安装尺寸，客户可根据实际情况调整。

Reference Value
参考值

Unit:mm
单位：毫米

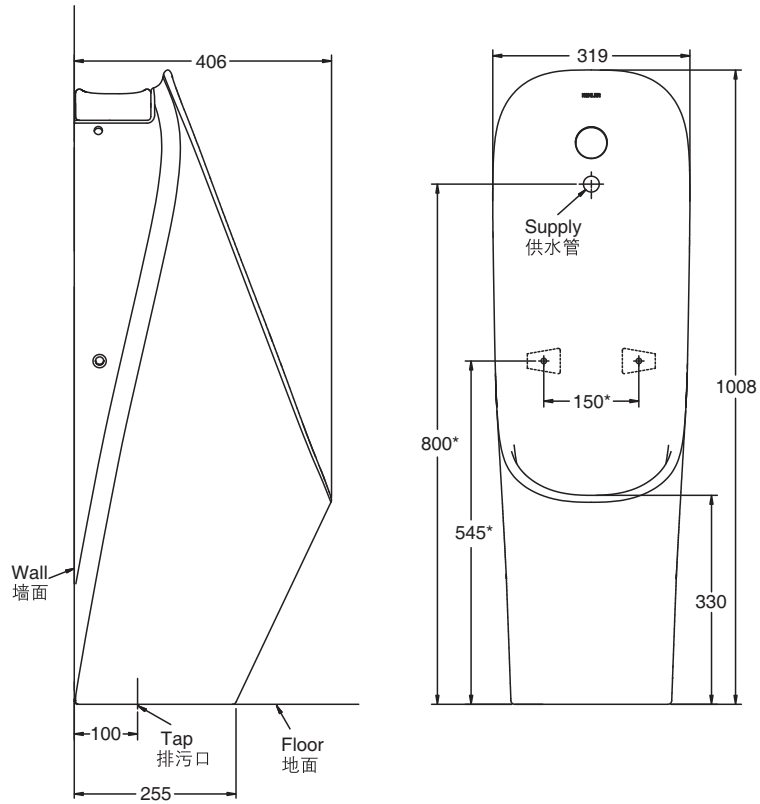

Fig.1
图1

Kohler reserves the right to change marked dimensions without prior notice.
科勒公司保留随时变更图中标示尺寸的权利，无需另行通知。

Notice: To ensure an effective flush performance, strongly recommended inner diameter of water supply (including water meter, valve, etc.) is no less than 25mm, and supplied water pressure (sensor inlet dynamic pressure) is 0.18MPa ~0.55MPa.

注意： 为保证有效冲洗，推荐供水管路(包括水表、阀等)内径不小于25mm，推荐供水水压(冲洗器进水口流动水压)：0.18MPa ~0.55MPa。

PREPARE THE SITE

NOTE: If a pre-existing waste pipe will be used and will result in an acceptable rim height (refer to the rough-in dimensions), follow the retrofit installation instructions.

For Retrofit Installations

- Turn the water supply line off, remove the existing urinal, then cap off the water supply line inside the wall.

For New Installations

- Install waste pipe as necessary to conform to the roughing-in dimensions.

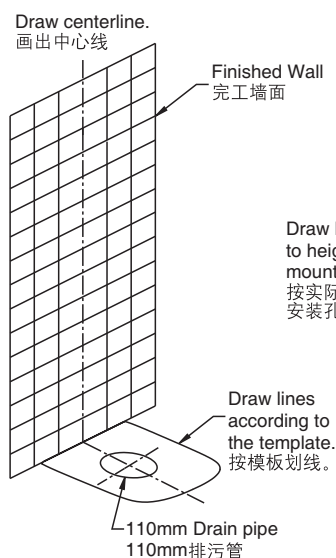

Draw lines according to height of the mounting hole center.
按实际产品两边的安装孔中心的高度划线。

Draw lines according to the template.
按模板划线。

110mm Drain pipe
110mm排污管

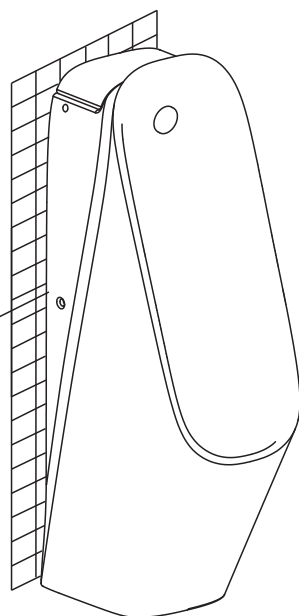

Fig.2
图2

准备场地

注意：如果现存的排水管可以使用，边缘高度符合要求(参考尺寸图)，则参照更换安装说明安装。

对于更换安装

- 关闭水源，移除现有的小便器，然后封住墙内的供水管线。

对于全新安装

- 如有必要，根据尺寸图安装排水管。

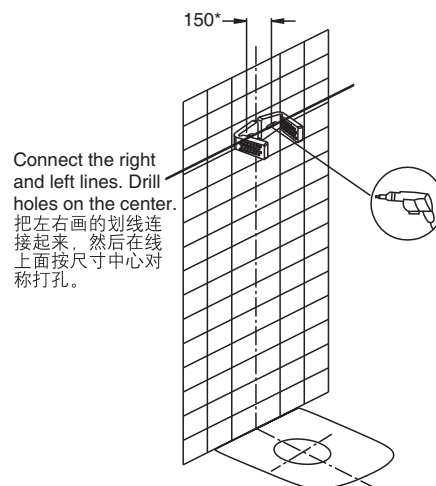

Connect the right and left lines. Drill holes on the center.
把左右画的划线连接起来，然后在线上面按尺寸中心对称打孔。

INSTALLATION

A. Draw bottom outline and centerline of the urinal according to the position of the drain pipe on the template. Extend the centerline to the wall. Put the urinal onto it and align with the bottom outline. Draw lines according to the height of the mounting holes and confirm the installation height of the L-shaped block. Draw centerline according to the width of the mounting holes. Drill holes and install L-shaped block, See Fig.2.

安装步骤

A. 按安装模板，利用地面排污管位置，画好陶瓷底部轮廓线和中心线，并把中心线延长到墙壁上。把小便器放上去，对齐底部的轮廓线，然后左右按安装小孔的高度划线，确定L形固定块的高度，再按图示安装孔的宽度对好中心线，然后打孔安装L形固定块，见图2。

B. Install urinal

1. Check the regulator, see Fig.3.

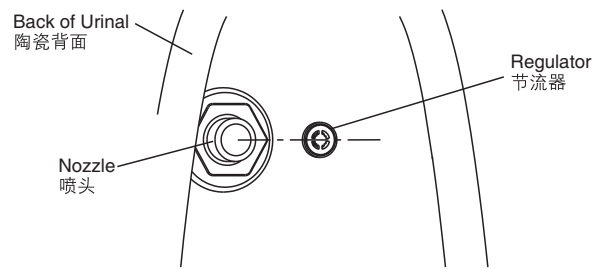

Fig.3
图3

2. Connect inlet pipe: connect the inlet pipe to the sensor (the inlet pipe can be purchased according to the actual position of the sensor).
3. Install flange (see Fig.4, optional for purchase). Put the urinal against wall and align the bottom with the lines drawn.
4. Insert the screw through the screw hole (see Fig.5.) Into the L-shaped fixing block. Tighten the screw.
5. Apply silicone sealant between the urinal and the wall.

B. 安装小便器

1. 检查节流器，确保节流器还在里面，见图3。

2. 连接进水管：将进水管连接到感应器上(客户可根据感应器的实际位置自行配置合适长度的进水管)。
3. 小便器装上黄油圈(见图4，客户自己选购)，然后把小便器底部对齐划线放好，背部靠墙。
4. 再把螺钉穿过安装孔(见图5)打在L形固定块上。然后上好。
5. 小便器和墙的间隙打上玻璃胶。

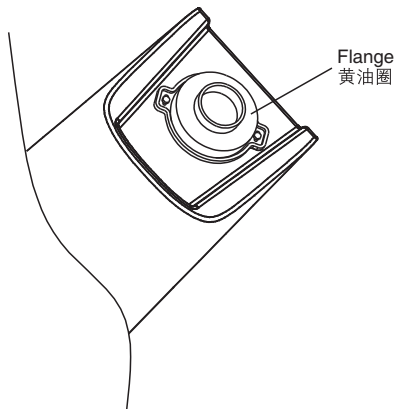

Fig.4
图4

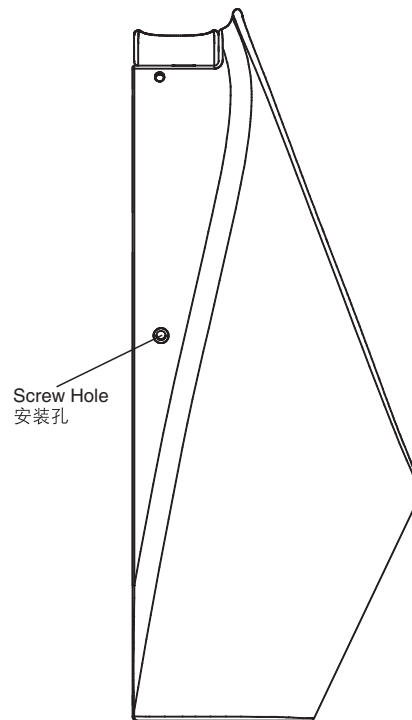



Fig.5
图5

C. Install Urinal Cover

See Fig.#6

1. Open urinal cover lock package and remove contents. Fix hook and screw as shown.
2. Put urinal cover on the urinal.
3. Use supplied locking tool to install and tighten the screw.
4. Check that the urinal cover is properly locked.

NOTE: Using a 5/8" wrench, assemble and tighten nut, washer and lock nut on both sides of urinal.

 **CAUTION:** Risk of chipping or breaking urinal. Do not overtighten screws on urinal.

C. 安装小便器盖

请参阅图6

1. 打开小便器盖包装，并取出所有物品。如图所示，分别安装挂钩和套筒螺丝。
2. 把小便器盖置于小便器上。
3. 用所附的工具安装并锁紧螺丝。
4. 检查并确保小便器盖锁好。

注意：在小便器两侧，用5/8"板钳组装并拧紧螺母。

 **警告：**小便器有破损和崩裂的危险。不要将螺丝上得过紧。

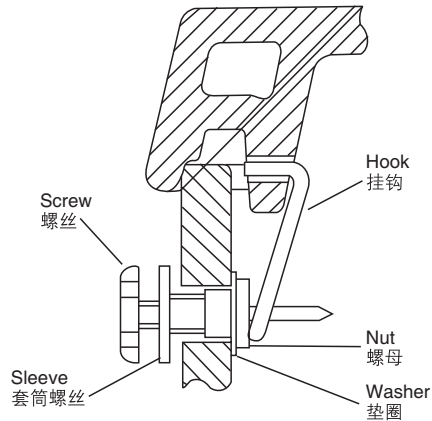



Fig.6
图6

CONSUMER RESPONSIBILITIES

If you live in a hard water area, make certain that the holes in the toilet rim are kept clean to ensure proper flushing. Toilet bowl cleaners should be used at least once a week. Use a long-handled brush to clean the rim holes, and to clean as far into the trap as possible to prevent mineral deposits from forming.

Most toilet bowl cleaners are not harmful to the vitreous china surface of the urinal. Please follow the bowl cleaner manufacturer's instructions carefully.

Do not use abrasive cleaners or solvents.

 **WARNING: Risk of property or product damage.** Do not use cleaners inside the wash basin. Products containing chlorine (calcium hypochlorite) can seriously damage fittings in the urinal. This damage can cause leakage and property damage.

Kohler Company shall not be responsible or liable for any damage to these urinal fittings caused by the use of cleaners containing chlorine (calcium hypochlorite).

 **WARNING:** Never spit phlegm and throw stub or something else into the urinal.

 **WARNING: Risk of product damage.** Do not throw into the urinal what is easy to block it, such as newspaper, paper pilch. Do not bump the vitreous china with great force to prevent it from damaging and leaking. Do not use the product in the water below 0°C.

 **CAUTION:** Please do not use hard materials (like scouring pad) to clean product surface, especially the product logo.

It is recommended to use sensors of KOHLER brand .

Urinal & Sensor matching table (附：小便斗与感应器配套表)

Urinal (小便斗)	Sensor (配套感应器)
1L	K-8881T-VC01/VC03-AF/BN, K-30939T-CP/BN,K-30941T-CP/BN,K-8872T-VC01-CP,K-45213T-CP, K-20368T-CP/SC,K-8988T-C01/C03-CP/SC
2.5L	K-8881T-UC01/UC03-AF/BN, K-30940T-CP/BN,K-30942T-CP/BN,K-8872T-C01/C03-CP, K-8787T-B01/B03-CP/SC, K-8431T-C01/C03-CP,K-8791T-C01/C03-CP/SC,K-45217T-CP, K-20369T-CP/SC

用户责任

如果你居住地方的水质是硬性，你必须保持冲水孔清洁，令小便器冲水正常。每星期应最少使用厕所清洁剂清洁一次，用长把手的刷子清洁冲水孔，并尽量伸入排污管洗刷，防止矿物质积聚。

大部份厕所清洁剂都不会损坏小便器表面的釉面陶瓷，但烦请遵照厕所清洁剂生产商指示小心进行。

请勿使用腐蚀性剂或溶剂。

 **警告：**提防楼宇受损或损坏产品。请勿使用小便池内用清洁剂。含氯(次氯酸钙)的清洁剂会严重破坏小便器附件，从而引起渗漏，或对楼宇结构造成损坏。

科勒公司对此类因使用氯(次氯酸钙)而引致的小便器附件损毁，概不负责。

 **警告：**请勿往小便器内吐痰、扔烟蒂等杂物。

 **警告：**提防损坏产品。请不要向小便器内冲入新闻纸、纸尿裤等容易堵塞的物品。请不要用重力撞击陶瓷，以防止破损漏水。

不要在0°C以下的水环境中使用。

 **警告：**请勿使用钢丝球等硬质材料擦洗产品表面，特别是产品商标处。

推荐使用科勒配套的感应器。