

KOHLER®

INSTALLATION INSTRUCTIONS

安装说明书

菲尔法斯 FAIRFAX

Widespread Lavatory Faucet

8658T 8 寸面盆龙头

安装之前

所有的资料是按最新出版的产品资料编写而成。科勒公司保留任何时候不经通知即可改变产品特性、包装或产品可供类型的权利。

说明书包括重要的安装、保养及清洁方面的内容,请把这些资料交给用户阅读。

注意事项:

1. 切断供水管路。
2. 检查供水管有无损坏。如需要,进行替换。
3. 遵守当地管路安装条例。
4. 尽可能在安装面盆之前安装水龙头。

BEFORE YOU BEGIN

All information is based on the latest product information available at the time of publication. Kohler Co. reserves the right to make changes in product characteristics, packaging, or availability at any time without notice.

Please leave these instructions for the consumer. They contain important information.

NOTES:

1. Shut off the water supplies to the fitting.
2. Inspect the supply tubing for damage. Replace as necessary.
3. Observe local plumbing codes.
4. If possible, install this faucet before installing the lavatory.

使用说明

逆时针旋转左把手为开,顺时针旋转右把手为开。

HANDLE OPERATION

Left handle opens with one-quarter turn counter-clockwise. Right handle opens with one-quarter turn clockwise.

安装尺寸

ROUGH-IN DIMENSIONS

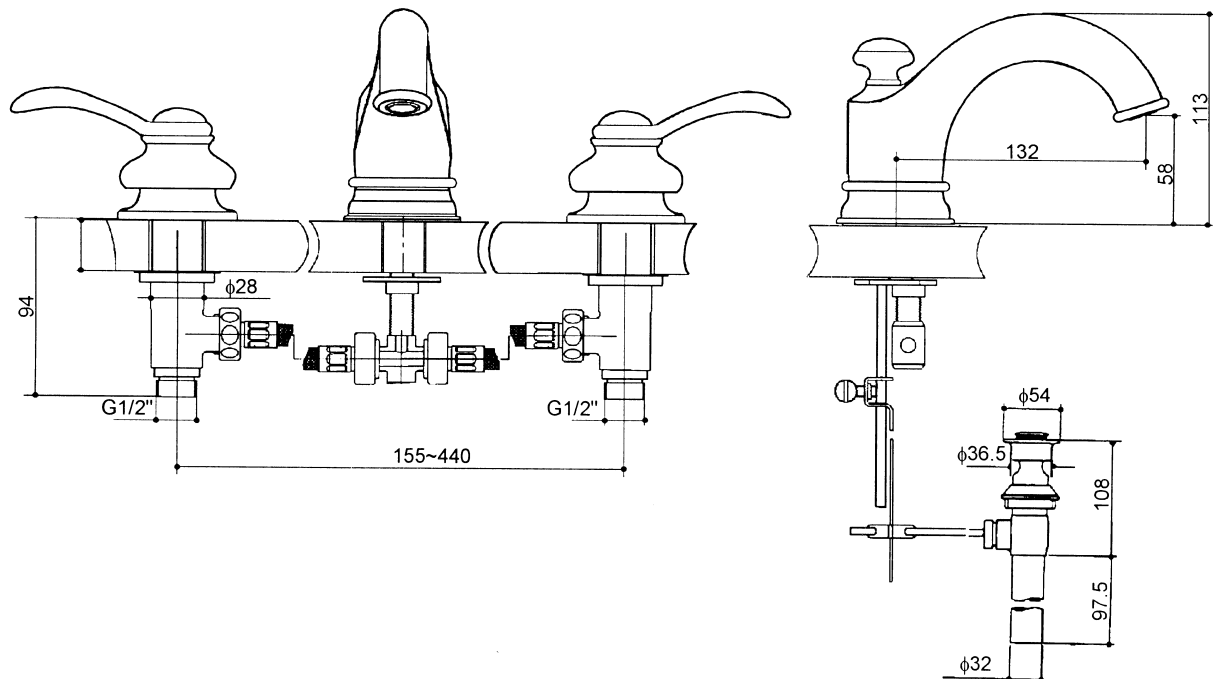

安装步骤

如何安装出水口

从出水口组件上依次取下 T 形接头(7)、塑料垫圈(6)、橡胶垫片(5)、螺母(4)和金属垫片(3)。

将垫片(1)装到出水口装饰盖底部,然后将龙头装于面盆中孔。

安装金属垫片(3)和螺母(4),调整好出水口的位置,用扳手拧紧螺母。

依次将塑料垫圈(6)、橡胶垫片(5)放入 T 形接头(7)内,然后将 T 形接头旋到出水口牙管(2)上,拧紧。

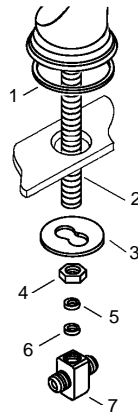

INSTALLATION

How To Install The Spout

Remove and retain the parts according to the following order: supply tee(7), plastic gasket(6), rubber washer(5), nut(4) and metal washer(3).

Slide the washer(1) on bottom of the escutcheon of the spout. Then fit the spout assembly to the center hole of lavatory.

Install the metal washer(3) and nut(4). Adjust the position of the spout and securely wrench tighten nut.

Put the gasket(6) and washer(5) into the supply tee(7). And then thread supply tee to the spout shank(2) until tight.

如何安装阀体

在每个阀体上装上螺母(12)和垫片(11)。从面盆的底部将阀体(13)穿过安装孔。在每一个阀体上装上垫片(9)和装饰盖(8)。

如图所示:将垫片放入软管(10)两端螺母中,然后分别与阀体和 T 形接头(7)连接。

注意:

将阀体定位,使得面向龙头时,贴有蓝色标记的阀体位于右面。为了安装方便,可以适当旋转阀体。确保软管水流顺畅。软管(10)只能用在此处。

用扳手将螺母(12)锁紧。

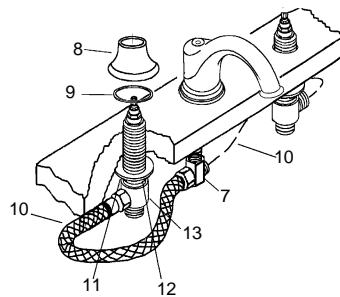

How To Install The Valve Bodies

Thread nut(12) and followed by a washer(11) onto each side body(13). Insert side bodies(13) through mounting holes from bottom of the lavatory. Put the washer(9) into the escutcheon(8) and then thread escutcheon onto each side body.

Put the washers into the nuts of the hose. Connect the side bodies and center tee with hoses(10) as in the drawing.

NOTE:

Install valve body with blue mark on the right when facing the front of the faucet. To ease installation, you may back off the side body. Ensure that there is no kinking of the supply hoses. The hoses(10) should only be used here.

Wrench tighten nut(12).

如何安装把手

调整两阀使其处于关闭状态。将把手(17)装到阀体上。将垫片(16)套到螺钉(15)上,再将螺钉通过把手顶部的孔旋到阀体上。将塞扣(14)塞入把手顶部的孔中。

把手安装完毕处于关闭状态的位置,如图所示:

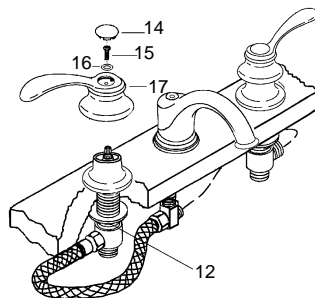

How To Install The Handles

Adjust the valves so that they are in the closed position. Install the handle(17) to the side body. Put the washer(16) on the screw(15), then screw it into the valve through the hole of the handle. Install the plug(14) on the top of the handle.

The configuration shown is the correct position of the handles in the closed position.

如何安装排水器

在排水器盘片(18)底面套上垫片(19)。把锁紧螺母(22)、垫片(21)和垫圈(20)(小面朝上)套在排水本体上。把排水本体由底下插入面盆,排水杆口朝后。

注: 如果需要,可直接在排水器盘片(18)底面沿周围涂上一圈密封油灰,而不使用垫片(19)。

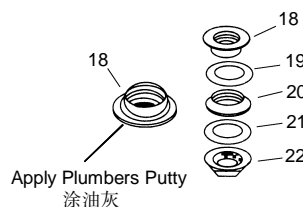

How To Install The Drain

Slide the washer(19) onto the underside of the drain flange(18). Slide the locknut(22), washer(21) and gasket(20) (Tapered side up) onto the drain body. Insert the drain body into the underside of the lavatory with the drain lever hole facing the rear.

NOTE: If needed apply a ring of plumbers putty around the underside of the drain flange(18), instead of using washer(19).

把排水器盘片旋入排水本体中。从下方用手拧紧锁紧螺母(26)。

把止水塞(23)放入排水本体(25)中,调整以使止水塞末端的洞口(24)靠近并对正排水杆的洞口(27)。

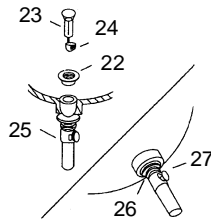

Thread the drain flange onto the drain body. Tighten the locknut (26) by hand from the underside of the fixture.

Place stopper(23) into drain body(27) aligning the flat side of stopper hole(24) with the drain lever hole(27).

把塑料垫片(29)、橡胶垫片(32)及固定螺母(28)装在球杆(30)上,再把球杆组件(33)插入排水杆的洞口(27)中并穿过止水塞,拧紧固定螺母(26)。

球杆指向面盆后方,并拧紧排水本体上的锁紧螺母,去除多余的油灰。

注意: 在锁紧螺母转紧后,不可调整排水本体的位置,否则会破坏油灰密封。

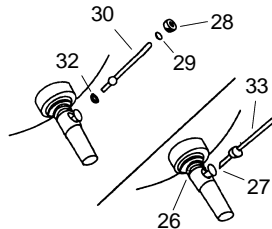

Fit the plastic washer (29), rubber washer (32), and retaining nut(28) onto the ball lever (30). Insert the ball lever assembly(33) into the drain lever hole (27) and through the stopper hole, and tighten the retaining nut.

Be sure that the ball lever points to the back of the lavatory, tighten the locknut on the drain body. Remove any excess putty.

NOTE: Do not reposition the drain after the locknut is tightened, or you may break the putty seal.

把带有提拉头(34)的提拉杆(35)插入本体提拉孔和联杆孔中。

把手捻螺丝(36)装到联杆(37)中,用V形夹(39)将联杆接在球杆(38)上,调整提拉杆的位置,使得提拉头的底部正好顶在水龙头的本体上。

将球杆往下推到排水器全开的位置。拧紧手捻螺丝。取下限位器扔掉。

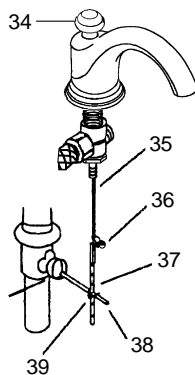

Insert the lift rod(35)with the lift rod knob(34) into the hole in the spout, and then into the link of the drain.

Assemble thumb screw(36) to link(37), and link onto ball lever rod(38) with "V"-clip(39). Position the lift rod so bottom of the knob rests against the faucet body.

Push the ball lever down into the open position. Tighten thumb screw. Remove and discard the spacer.

安装结果检查

连接尾管和存水弯。确保已拧紧所有连接处。取下起泡器(40)。打开排水器。打开主供水源,检查泄漏。打开冷热水阀,使水流过出水口,除掉杂物,关闭阀。重新安装起泡器。

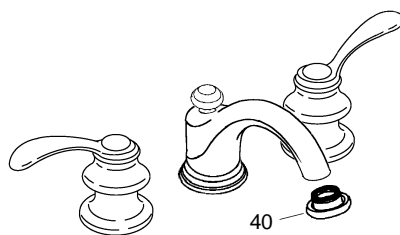

INSTALLATION CHECKOUT

Connect the tailpiece and P-trap. Ensure that all connections are tight. Remove the aerator(40). Open the drain. Turn on the main supply and check for leaks. Open both hot and cold valves and run water through the spout to remove any debris. Turn the valve off. Reinstall the aerator.

清理说明

适用于所有加工处理过的表面: 以中性肥皂水清洗镀层表面,再以干净的软布彻底擦干整个表面,许多清洁剂,比如氨水、去污粉及洁厕灵等,会对电镀表面造成伤害,切忌使用。

有腐蚀性的清洁剂或溶剂不可使用于科勒牌的水龙头及其附件上。

CLEANING INSTRUCTIONS

All Finishes: Clean the finish with a mild soap and warm water. Wipe entire surface completely dry with a clean soft cloth. Many cleaners may contain chemicals, such as ammonia, chlorine, toilet cleaner etc. which could adversely affect the finish and are not recommended for cleaning. Do not use abrasive cleaners or solvents on Kohler faucets and fittings.

8658T 8寸面盆龙头

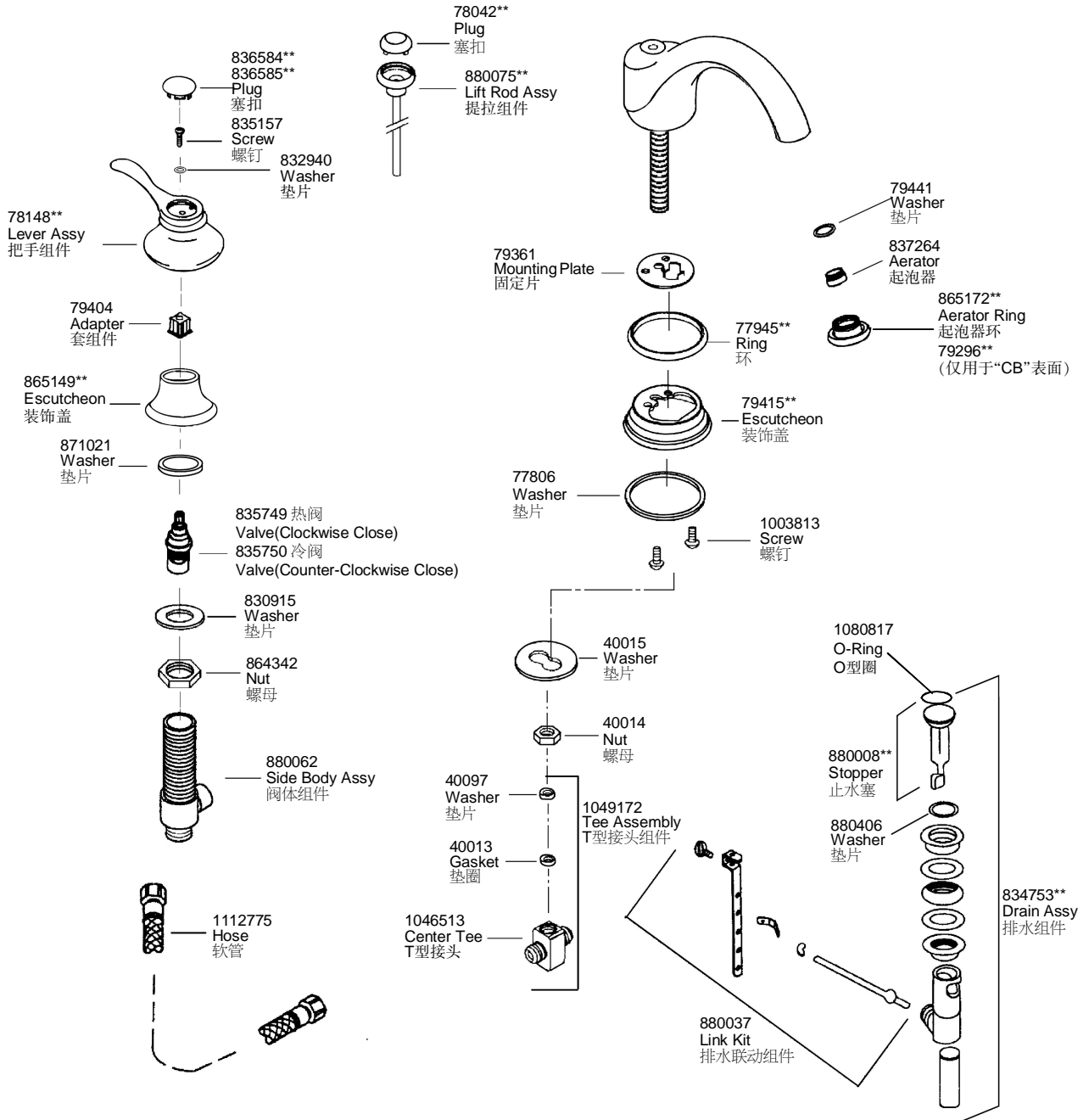

** 订购时请说明颜色编号

**Color code must be specified when ordering.