

Craft Series Vanity
CVSK36 Skaarsgard Vanity Specification Sheet

FEATURES

- Three-way mitered vanity joinery
- Mitered thin frame drawer detail
- Top drawer is a plumbing drawer
- Bottom drawer is a plumbing drawer
- Open shelf storage
- Removable glass drawer dividers included

MATERIALS & CONSTRUCTION

- Solid wood and veneer construction
- Full plywood back panel, no cutout
- Dovetailed drawers
- Pre-installed solid stainless steel hardware
- Blum full extension slow close drawer slides
- Durable, moisture resistant polyurethane finish
- Adjustable leveling feet

OPTIONS

- Available in:
 - CVSK3620469 - Rustic Oak with Brushed Pewter
- Coordinating mineral cast sink:
 - TA36MCO102-8CS8, Matte White
- Coordinating mirrors available
- Coordinating linen cabinet available

DIMENSIONS

- Width: 35-5/8" (904 mm)
- Height: 28-3/16" (715 mm)
- Depth: 22-3/4" (579 mm)

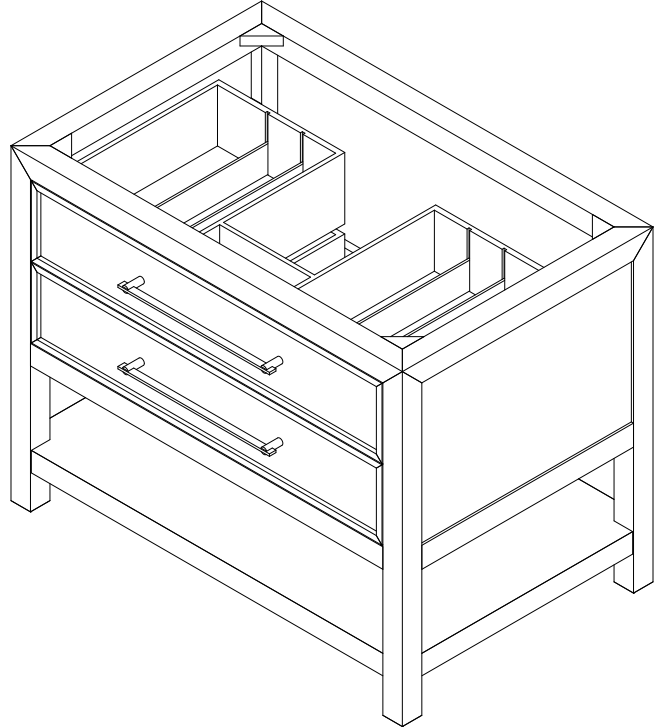

MODEL NUMBER KEY

PRODUCT LINE	CATEGORY	COLLECTION	WIDTH	FINISH OPTIONS
C = Craft Series	V = Vanity	SK = Skaarsgard	36	(See above)

MORE INFORMATION

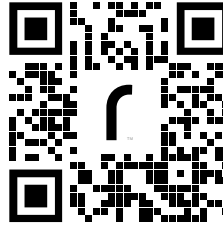

Scan the QR code to see the details found in the Craft Vanity installation instructions.

Use the camera app on your mobile device to look at this QR code. This will allow you to quickly access web pages and other relevant documents.

