

**Features**

- Handleless ergonomic continuous drawers
- Includes 1 glass center bin
- Includes 2 fully adjustable glass drawer dividers
- False front allows for standard undermount sink
- Glass side kits included

**Dimensions**

**Width:** 36-1/8" (918 mm) - with side kits installed  
**Depth:** 21-7/8" (556 mm)  
**Overall Height:** 34-1/2" (876 mm)  
**Total Drawer Height:** 22-1/2" (572 mm)

**Construction**

- All metal and glass construction - aluminum structural frame and drawer sides, glass drawer fronts, safety backed glass drawer bottom, and Stainless Steel Legs
- Heavy duty, full extension, soft close drawers slides
- Glass fronts and side kits are replaceable
- Industrial grade installation hardware

**Codes/Standards Applicable**

- Optional Night Light Option is ETL certified to:
  - UL 2108
  - CSA Standard C22.2 No. 250
- Optional Electric outlet accessory is ETL certified to:
  - UL 1363
  - CSA Standard C22.2 No. 21

**Options**

- Other widths available
- Integrated LED night light (S) - Light bar built into top frame provides drawer illumination

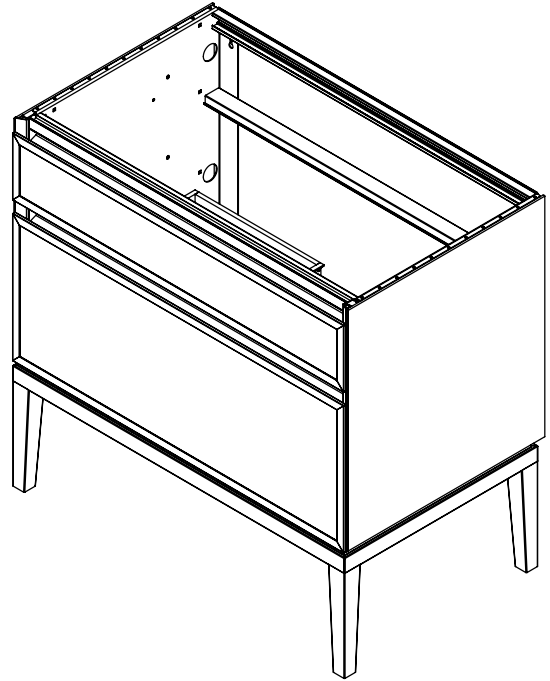

**Model Number Key**

Vanity	Profiles	Width	Height	Depth	Drawer Type	Glass Finish	Night Light	Metal Frame Finish
V	P	36	H3 = 22-1/2"	D21 = 21-3/4"	A = H1 False Front, H2 Plumbing Drawer, H3 Side Kit Pair, and SS Legs	11 = Tinted Gray Mirror 21 = White 26 = Matte White 27 = Matte Gray	N = Base Unit S = Selectable 2700K / 4000K	76 = Chrome

## Electrical System

- Optional Night light option - 12VDC plug-in transformer  
Locate wall outlet as per installation instructions 209-1335
- Optional In-drawer 3 outlet and switch box accessory - plug-in cord 120VAC 20A outlet

## Optional Accessories

- Insert Plumbing Drawer (VADRAWER36P)
- In drawer electrical outlets (VAELECTRIC21)
- Assorted glass bins:
  - Divided storage (GLASSBIN6.38)
  - Small (GLASSBIN3.25)
  - Medium (GLASSBIN5.25)
  - Large (GLASSBIN8.5)
- Hair Styling Organizer (VAHAIRORG)
- Accessory night light (SLEDS36)

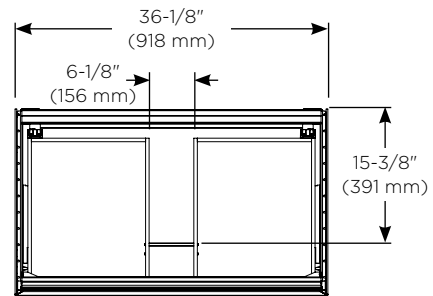

Top view for plumbing

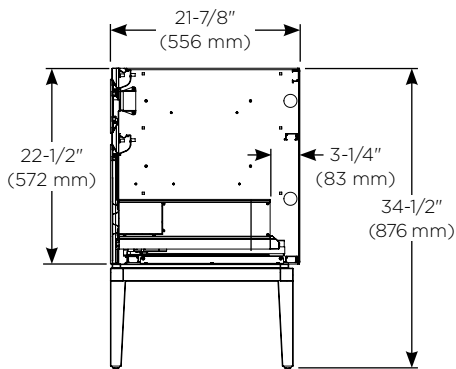

Side view for plumbing

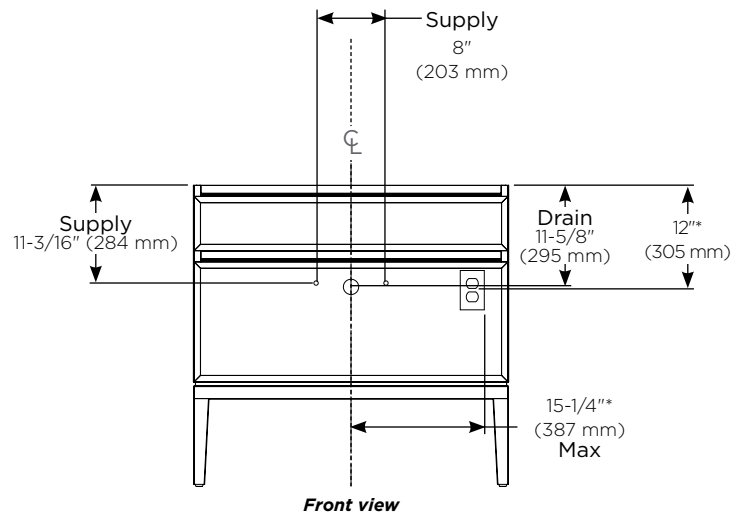

\*Rough in location for optional night light

## Installation Notes

**Install this product according to the installation guide 209-1335.**

- Special site preparation is required. Wall bracing and Robern supplied hardware are recommended.
- The plumbing must be roughed into the plumbing cutout area of the vanity. Refer to the sink rough-in and the vanity rough-in for proper placement. The water supply and drain lines must be installed before installing the vanity.