

Features

- Console Vanity
- Handleless ergonomic continuous drawer
- Tip-out front storage version allows for standard undermount sink
- Left and right side tip outs for additional storage

Construction

- All aluminum and glass construction - designed for disassembly and recycle, aluminum structural frame and drawer sides, glass drawer fronts, and safety backed glass drawer bottom
- One piece extruded & CNC machined aluminum legs
- Structural front legs and wall hanging rear supports
- Glass fronts and side tip outs are replaceable
- Includes installation hardware using secure structural bolts

Codes/Standards Applicable

- Night Light Option is ETL certified to:
 - UL 2108
 - CSA Standard C22.2 No. 12

Dimensions

Height: 34-1/2" (876 mm)
 Width: 30-1/2" (775 mm)
 Depth: 21-3/4" (552 mm)

Options

- Hidden side storage organizing solutions
- Integrated LED night light (L) - Light bar built into top frame provides drawer illumination
- Glass finish options: Mirror, patterned glass, and back painted glass - gloss or matte
- Leg finish options: Chrome, Brushed Nickel, and Brushed Black
- Other widths available - 36" (927 mm) / 42" (1080 mm)
- Plumbing Drawer (P) or Front Tip Out - H1 only (T)
- 15" (381 mm) H2 drawer height available (VB30H2D21P##_##)

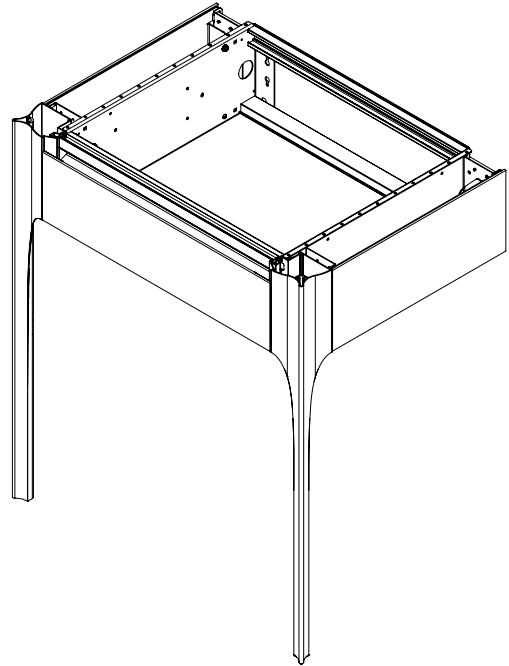

Model Number Key

Vanity	Balletto	Width	Height	Depth	Drawer Style	Glass Finish	Light	Leg Finish
V	B	30"	H1 = 7-1/2"	D21 = 21-3/4"	T = Tip Out	10 = Mirror 11 = Tinted Gray Mirror 12 = Satin Bronze 19 = Satin White 20 = Black 21 = White 22 = Beach 23 = Ocean 24 = Smoke Screen 25 = Silver Screen 26 = Matte White 27 = Matte Gray 28 = Matte Black	N = Base L = Night Light	71 = Brushed Nickel 74 = Brushed Black 76 = Chrome

Electrical System

- Night light option - 12VDC plug-in transformer
Locate wall outlet as per installation instructions 209-1242

Optional Accessories

- Side storage solutions Articulating (VALEVELH1)
- Robern Engineered Stone Tops and porcelain sink available

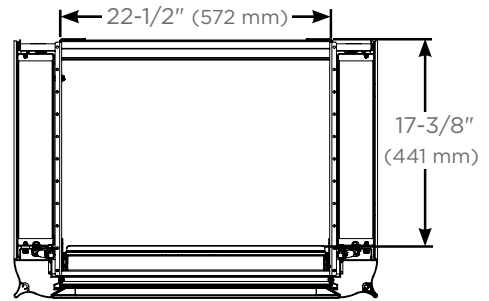

Top view for plumbing and sink clearance

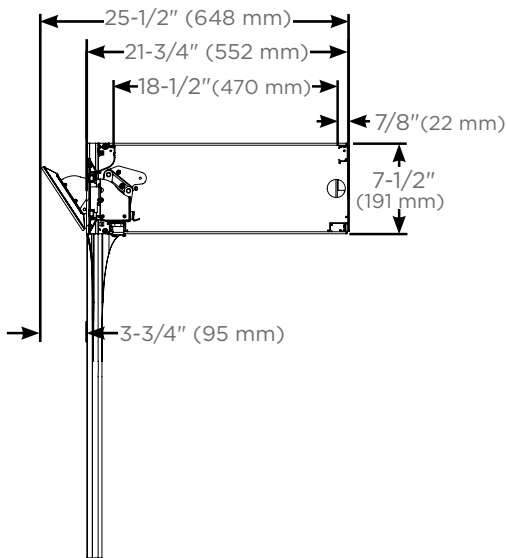

Side view for plumbing and sink clearance
with front tip-out

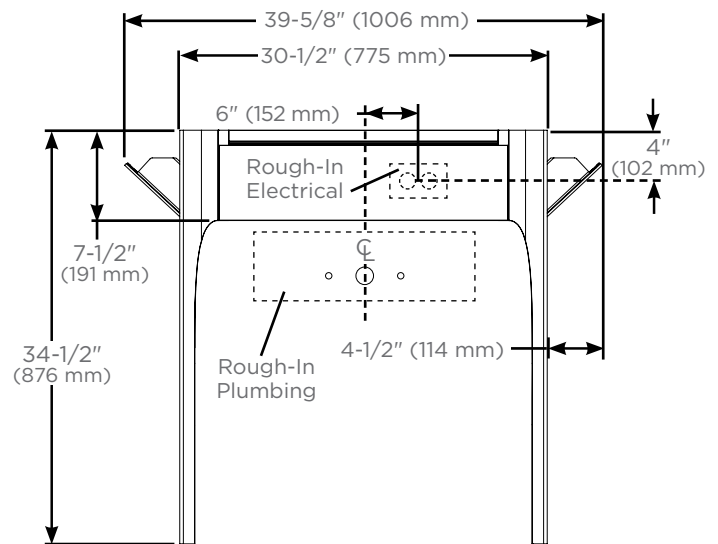

Front view with side storage

Installation Notes

Install this product according to the installation guide 209-1242.

- The Robern Engineered Stone Tops and porcelain sinks are recommended for this vanity.
- Special site preparation is required. Wall bracing and Robern supplied hardware are recommended.
- If a sink will be installed, the plumbing must be roughed into the plumbing cutout area of the vanity. Refer to the sink rough-in and the vanity rough-in for proper placement. The water supply and drain lines must be installed before installing the vanity.