

Features

- Trim plate includes temperature control knob with integrated adjustable high-temperature limit stop and shower outlet on/off buttons
- When pressed once, shower outlet turns on and button pops out, becoming a knob for water flow adjustment
- When pressed back in, water turns off and outlet button aligns with control plate surface; flow setting remains intact
- High-temperature limit setting for added safety
- Low-profile design with easy-to-clean water-resistant casing
- Requires four-port thermostatic valve with integral volume control (sold separately)
- Handles up to 8 gpm (30.3 lpm) flow capacity (rate may vary by installation)



Installation

- Mounts on finished wall surface

Required Products/Accessories

P34725-00 Mechanical showering four-port thermostatic valve with integrated volume control

Codes/Standards









ASME A112.18.1/CSA B125.1

KALLISTA® Five-Year Limited Warranty

See website for detailed warranty information.

Available Colors/Finishes

Color tiles intended for reference only.

Color	Code	Description
	CP	Polished Chrome
	BL	Matte Black
	AF	French Gold
	PB	Polished Brass
	BV	Brushed Bronze
	BAF	Brushed French Gold
	SN	Polished Nickel
	BN	Brushed Nickel

KALLISTA

Foundations by KALLISTA
Mechanical showering four-outlet thermostatic
control panel
P34721-00

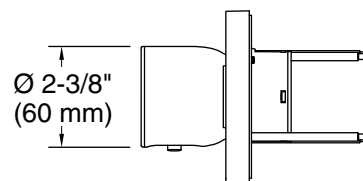
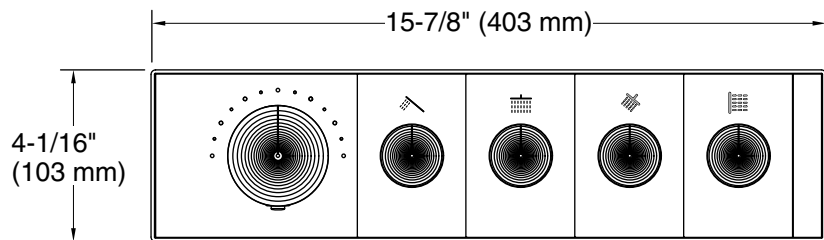
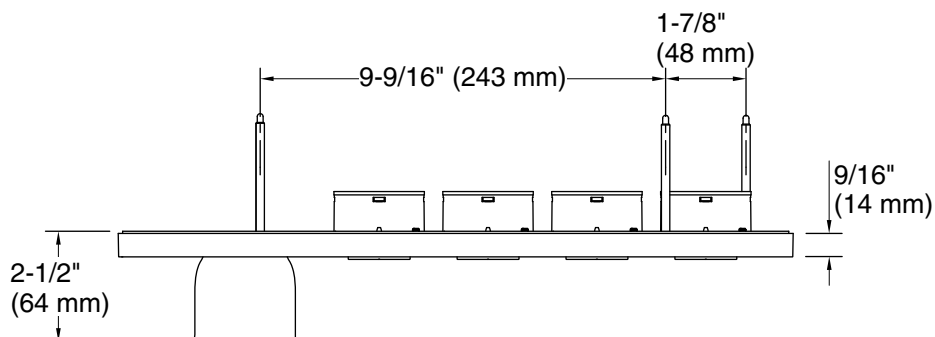

Technical Information

All product dimensions are nominal.

Notes

Install this product according to the installation instructions.