

KALLISTA®

002™ by KALLISTA
Single Control trim, lever handle
P34130-LV

Features

- High-quality metal construction for durability and reliability
- Maintains water temperature within +/-3 degrees Fahrenheit
- Features a high-temperature-limit stop to help prevent scalding
- Required rough-in sold separately

Required Products/Accessories

P29500-WS Thermostatic rough-in with volume control & stops

or

P19310-00 Pressure Balance Rough-In

or

P19310-WS Pressure Balance Rough-In Valve With Stops

Recommended Products/Accessories

P34135-00 Round Contemporary Showerhead with Arm

P34137-00 Towel Bar, 24"

P24843-00 Wand Dual-Function Handshower with Hose

P21513-00 Air-Induction Large Contemporary Rain Showerhead



ADA **CSA B651** **OBC**

Codes/Standards

ASME A112.18.1/CSA B125.1

ADA

ICC/ANSI A117.1

CSA B651

OBC





IAPMO Certification

KALLISTA® Five-Year Limited Warranty

See website for detailed warranty information.

Available Colors/Finishes

Color tiles intended for reference only.

Color	Code	Description
	CP	Polished Chrome
	BL	Matte Black
	BN	Brushed Nickel
	SN	Polished Nickel
	BAF	Brushed French Gold

1-888-4-KALLISTA (1-888-452-5547)

Kallista reserves the right to make revisions without notice to product specifications.

For the most current Specification Sheet, go to www.kallista.com.

6-11-2024 21:03 - US

KALLISTA®

002™ by KALLISTA
Single Control trim, lever handle
P34130-LV

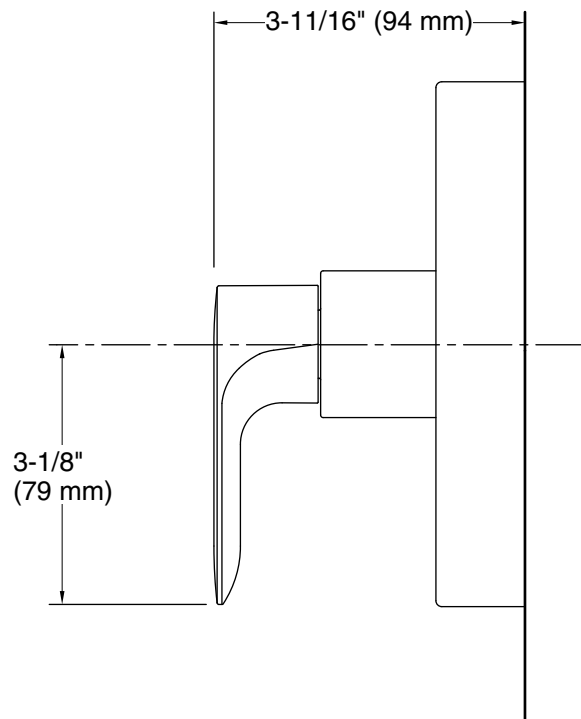
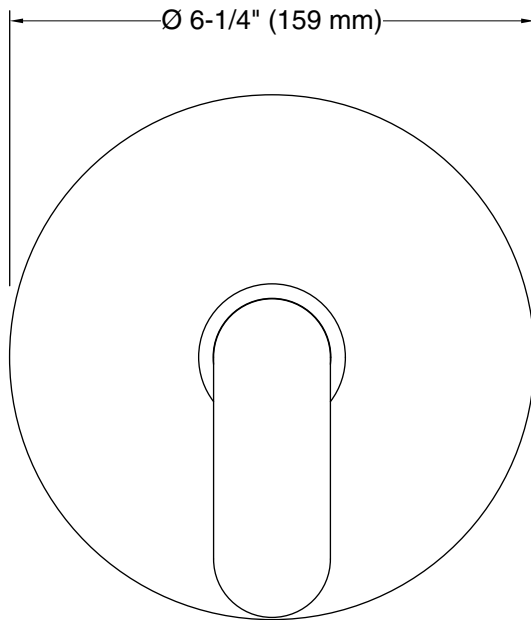

Technical Information

All product dimensions are nominal.

Drain included: No

Notes

Install this product according to the installation guide.

ADA, OBC, CSA B651 compliant when installed to the specific requirements of these regulations.