

## Features

- High-quality solid brass construction for durability and reliability
- Integrated supply
- Integrated handshower bracket
- ADA compliant
- 33-3/16" (843 mm) total height

## Recommended Products/Accessories

P21660-00 (Qty 2)  
P21665-00  
P24712-00  
P22078-H  
P21652-00



**ADA** **CSA B651** **OBC**

## Codes/Standards











ASME A112.18.1/CSA B125.1  
ADA  
ICC/ANSI A117.1  
CSA B651  
OBC

## KALLISTA® Five-Year Limited Warranty

See website for detailed warranty information.

## Available Colors/Finishes

*Color tiles intended for reference only.*

Color	Code	Description
	AD	Nickel Silver
	CP	Polished Chrome
	AG	Brushed Nickel
	GN	Gunmetal
	BL	Matte Black
	LB	Bronze
	W7	Black Nickel
	BAF	Brushed French Gold
	GNP	Gunmetal
	SN	Polished Nickel
	AF	French Gold

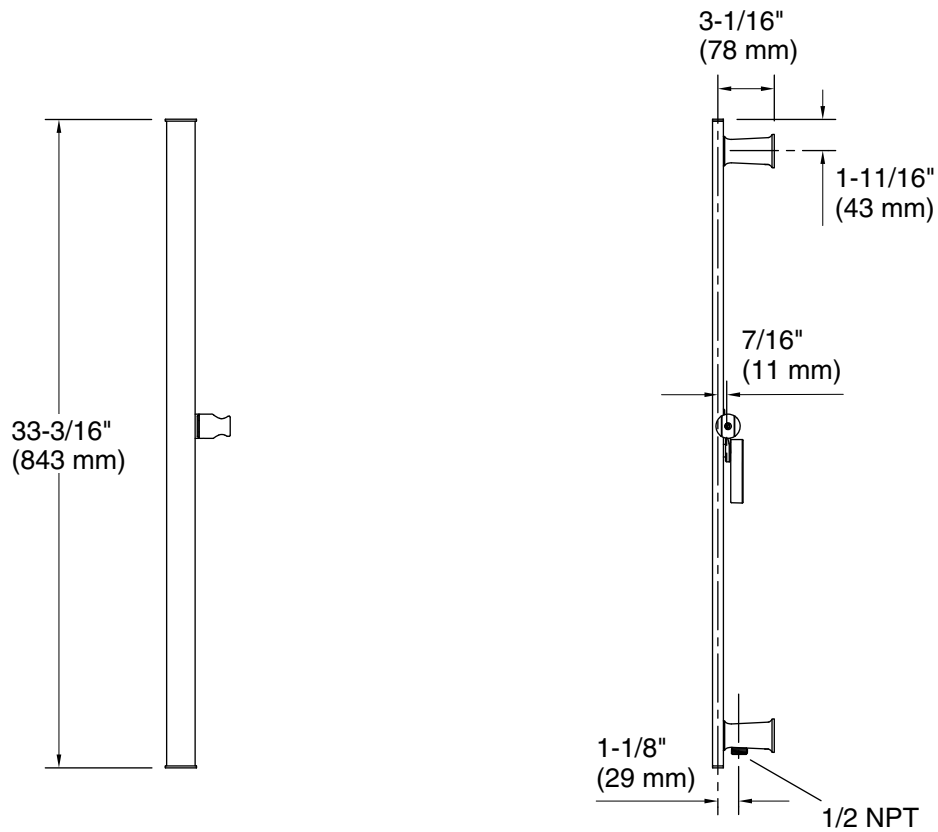

## Technical Information

All product dimensions are nominal.

Drain included: No

## Notes

ADA, OBC, CSA B651 compliant when installed to the specific requirements of these regulations.