

# Operation

## Residential/Light Commercial Generator Sets



Model:

**38RCL**  
**48RCL**  
**48RCLA**  
**60RCL**

Controller:

**RDC2**

**ISO 9001**  
**KOHLER**  
POWER SYSTEMS  
NATIONALLY REGISTERED

**KOHLER**  
Power Systems

TP-6810 7/16d

**California Proposition 65**

**⚠ WARNING**

Engine exhaust from this product contains chemicals known to the State of California to cause cancer, birth defects, or other reproductive harm.

**California Proposition 65**

**⚠ WARNING**

This product contains and/or emits chemicals known to the State of California to cause cancer, birth defects, or other reproductive harm.

**Kohler strongly recommends  
that only factory-authorized  
distributors or dealers install  
and service the generator.**

**Product Identification Information**

Product identification numbers determine service parts. Record the product identification numbers in the spaces below immediately after unpacking the products so that the numbers are readily available for future reference. Record field-installed kit numbers after installing the kits.

**Accessory Number**

**Accessory Description**

_____	_____
_____	_____
_____	_____
_____	_____
_____	_____
_____	_____
_____	_____
_____	_____
_____	_____
_____	_____
_____	_____
_____	_____

**Generator Set Identification Numbers**

Record the product identification numbers from the generator set nameplate(s).

Model Designation \_\_\_\_\_

Specification Number \_\_\_\_\_

Serial Number \_\_\_\_\_

**Controller Identification**

Record the controller description from the generator set operation manual, spec sheet, or sales invoice.

Controller Description \_\_\_\_\_

**Engine Identification**

Record the product identification information from the engine nameplate.

Manufacturer \_\_\_\_\_

Model Designation \_\_\_\_\_

Serial Number \_\_\_\_\_

# Table of Contents

<b>Product Identification Information</b> .....	<b>2</b>
<b>Safety Precautions and Instructions</b> .....	<b>5</b>
<b>Introduction</b> .....	<b>9</b>
<b>Service Assistance</b> .....	<b>11</b>
<b>Section 1 Service Views</b> .....	<b>13</b>
<b>Section 2 Generator Set Operation</b> .....	<b>15</b>
2.1 Operating Area .....	15
2.2 Prestart Checklist .....	15
2.3 Exercising the Generator Set .....	17
2.4 Generator Set Operation .....	17
2.4.1 Local Starting and Stopping .....	17
2.4.2 Automatic Starting and Stopping .....	17
2.4.3 Remote Starting and Stopping .....	17
2.4.4 Engine Start Crank Cycle .....	17
2.4.5 Engine Cooldown .....	17
2.4.6 Automatic Operation with Model RXT Transfer Switch .....	18
2.4.7 Automatic Operation with Other Transfer Switches .....	18
2.5 Exercise .....	18
2.5.1 Unloaded Cycle Exercise with Complete System Diagnostics .....	18
2.5.2 Unloaded Full-Speed Exercise .....	19
2.5.3 Loaded Full-Speed Exercise (with RXT only) .....	19
2.5.4 Shutdown During Exercise .....	19
2.5.5 Power Failure During Exercise .....	20
2.5.6 Exerciser Reset .....	20
2.5.7 Setting the Exerciser at Power-up .....	20
2.5.8 Changing the Exercise Setting .....	20
2.6 Faults .....	23
2.6.1 Warnings .....	23
2.6.2 Shutdowns .....	23
2.6.3 ATS Communication Errors .....	23
2.6.4 Resetting the Controller after a Fault Shutdown .....	23
2.6.5 Event Log .....	26
2.7 Model RXT Transfer Switch Operation .....	26
2.7.1 Source Availability .....	26
2.7.2 ATS Control Sequence of Operation .....	27
2.7.3 Time Delays .....	27
2.7.4 ATS Load Control Relay Time Delay .....	27
<b>Section 3 RDC2 Controller Operation</b> .....	<b>29</b>
3.1 RDC2 Generator Set/Transfer Switch Controller .....	29
3.2 Controls and Indicators .....	29
3.2.1 Controller Keypad .....	30
3.2.2 LED Indicators .....	30
3.2.3 LCD Display .....	31
3.3 Controller Power .....	32
3.4 Battery Charging .....	32
3.5 Changing Settings .....	32
3.6 Controller Menus .....	34
3.7 Main Menu .....	34
3.8 Overview Menu .....	35
3.9 Engine Metering Menu .....	35
3.10 Generator Metering Menu .....	36
3.11 Generator Set Information Menu .....	37

# Table of Contents, continued

---

3.12	Genset Run Time Menu .....	37
3.13	Genset System Menu .....	38
3.14	ATS Status Menu .....	39
3.15	ATS Configuration Menu .....	40
3.16	Date and Time Menu .....	41
3.17	Networking Information Menus .....	42
3.17.1	Networking Status Submenu .....	43
3.17.2	Networking Configuration Submenu (OnCue Plus Password) .....	44
3.17.3	RBUS Information Submenu .....	45
3.17.4	Remote Devices Submenu .....	46
3.18	Programmable Interface Module (PIM) Menus .....	47
3.19	Load Control Menus .....	48
<b>Section 4 Scheduled Maintenance .....</b>		<b>49</b>
4.1	General Maintenance .....	49
4.2	Service Schedule .....	51
4.3	Lubrication System .....	52
4.3.1	Oil Specifications .....	52
4.3.2	Oil Check .....	52
4.3.3	Oil Additions .....	52
4.3.4	Oil and Filter Change .....	52
4.4	Air Cleaner .....	54
4.5	Exhaust System .....	55
4.6	Cooling System .....	56
4.6.1	Checking and Filling Coolant .....	56
4.6.2	Cooling System Inspection .....	56
4.6.3	Draining Cooling System .....	56
4.6.4	Flushing and Cleaning .....	57
4.6.5	Filling Cooling System .....	57
4.7	Ignition System .....	57
4.8	Battery .....	59
4.8.1	Checking Electrolyte Level .....	60
4.8.2	Checking Specific Gravity .....	61
4.9	Storage Procedure .....	62
<b>Section 5 Troubleshooting .....</b>		<b>63</b>
5.1	Introduction .....	63
5.2	USB Port .....	63
5.3	Fault Messages .....	63
5.4	Circuit Protection .....	63
5.4.1	Load Circuit Breaker .....	63
5.4.2	Fuses .....	63
5.4.3	Controller Internal Circuit Protection .....	63
5.5	Generator Set Troubleshooting .....	64
5.6	Controller Troubleshooting .....	65
<b>Appendix A Abbreviations .....</b>		<b>67</b>

# Safety Precautions and Instructions

**IMPORTANT SAFETY INSTRUCTIONS.** Electromechanical equipment, including generator sets, transfer switches, switchgear, and accessories, can cause bodily harm and pose life-threatening danger when improperly installed, operated, or maintained. To prevent accidents be aware of potential dangers and act safely. Read and follow all safety precautions and instructions. **SAVE THESE INSTRUCTIONS.**

This manual has several types of safety precautions and instructions: Danger, Warning, Caution, and Notice.

## DANGER

Danger indicates the presence of a hazard that **will cause severe personal injury, death, or substantial property damage.**

## WARNING

Warning indicates the presence of a hazard that **can cause severe personal injury, death, or substantial property damage.**

## CAUTION

Caution indicates the presence of a hazard that **will or can cause minor personal injury or property damage.**

## NOTICE

Notice communicates installation, operation, or maintenance information that is safety related but not hazard related.

Safety decals affixed to the equipment in prominent places alert the operator or service technician to potential hazards and explain how to act safely. The decals are shown throughout this publication to improve operator recognition. Replace missing or damaged decals.

## Accidental Starting

### WARNING

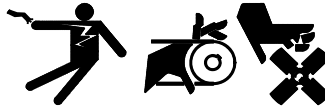

**Accidental starting.  
Can cause severe injury or death.**

Disconnect the battery cables before working on the generator set. Remove the negative (-) lead first when disconnecting the battery. Reconnect the negative (-) lead last when reconnecting the battery.

**Disabling the generator set. Accidental starting can cause severe injury or death.** Before working on the generator set or equipment connected to the set, disable the generator set as follows: (1) Press the generator set off/reset button to shut down the generator set. (2) Disconnect the power to the battery charger, if equipped. (3) Remove the battery cables, negative (-) lead first. Reconnect the negative (-) lead last when reconnecting the battery. Follow these precautions to prevent the starting of the generator set by the remote start/stop switch.

## Battery

### WARNING



**Sulfuric acid in batteries.  
Can cause severe injury or death.**

Wear protective goggles and clothing. Battery acid may cause blindness and burn skin.

### WARNING



**Explosion.  
Can cause severe injury or death.  
Relays in the battery charger  
cause arcs or sparks.**

Locate the battery in a well-ventilated area. Isolate the battery charger from explosive fumes.

**Battery electrolyte is a diluted sulfuric acid. Battery acid can cause severe injury or death.** Battery acid can cause blindness and burn skin. Always wear splashproof safety goggles, rubber gloves, and boots when servicing the battery. Do not open a sealed battery or mutilate the battery case. If battery acid splashes in the eyes or on the skin, immediately flush the affected area for 15 minutes with large quantities of clean water. Seek immediate medical aid in the case of eye contact. Never add acid to a battery after placing the battery in service, as this may result in hazardous spattering of battery acid.

**Battery acid cleanup. Battery acid can cause severe injury or death.** Battery acid is electrically conductive and corrosive. Add 500 g (1 lb.) of bicarbonate of soda (baking soda) to a container with 4 L (1 gal.) of water and mix the neutralizing solution. Pour the neutralizing solution on the spilled battery acid and continue to add the neutralizing solution to the spilled battery acid until all evidence of a chemical reaction (foaming) has ceased. Flush the resulting liquid with water and dry the area.

**Battery gases. Explosion can cause severe injury or death.** Battery gases can cause an explosion. Do not smoke or permit flames or sparks to occur near a battery at any time, particularly when it is charging. Do not dispose of a battery in a fire. To prevent burns and sparks that could cause an explosion, avoid touching the battery terminals with tools or other metal objects. Remove all jewelry before servicing the equipment. Discharge static electricity from your body before touching batteries by first touching a grounded

metal surface away from the battery. To avoid sparks, do not disturb the battery charger connections while the battery is charging. Always turn the battery charger off before disconnecting the battery connections. Ventilate the compartments containing batteries to prevent accumulation of explosive gases.

**Battery short circuits. Explosion can cause severe injury or death.**

Short circuits can cause bodily injury and/or equipment damage. Disconnect the battery before generator set installation or maintenance. Remove all jewelry before servicing the equipment. Use tools with insulated handles. Remove the negative (-) lead first when disconnecting the battery. Reconnect the negative (-) lead last when reconnecting the battery. Never connect the negative (-) battery cable to the positive (+) connection terminal of the starter solenoid. Do not test the battery condition by shorting the terminals together.

**Engine Backfire/Flash Fire**

<b>⚠ WARNING</b>

<p><b>Risk of fire.</b>  <b>Can cause severe injury or death.</b></p> <p>Do not smoke or permit flames or sparks near fuels or the fuel system.</p>

**Servicing the fuel system. A flash fire can cause severe injury or death.** Do not smoke or permit flames or sparks near the carburetor, fuel line, fuel filter, fuel pump, or other potential sources of spilled fuels or fuel vapors. Catch fuels in an approved container when removing the fuel line or carburetor.

**Servicing the air cleaner. A sudden backfire can cause severe injury or death.** Do not operate the generator set with the air cleaner removed.

**Combustible materials. A fire can cause severe injury or death.** Generator set engine fuels and fuel vapors are flammable and explosive. Handle these materials carefully to

minimize the risk of fire or explosion. Equip the compartment or nearby area with a fully charged fire extinguisher. Select a fire extinguisher rated ABC or BC for electrical fires or as recommended by the local fire code or an authorized agency. Train all personnel on fire extinguisher operation and fire prevention procedures.

**Exhaust System**

<b>⚠ WARNING</b>

<p><b>Carbon monoxide.</b>  <b>Can cause severe nausea, fainting, or death.</b></p> <p>The exhaust system must be leakproof and routinely inspected.</p>

**Generator set operation. Carbon monoxide can cause severe nausea, fainting, or death.** Carbon monoxide is an odorless, colorless, tasteless, nonirritating gas that can cause death if inhaled for even a short time. Avoid breathing exhaust fumes when working on or near the generator set. Never operate the generator set inside a building. Never operate the generator set where exhaust gas could seep inside or be drawn into a potentially occupied building through windows, air intake vents, or other openings.

**Carbon monoxide symptoms. Carbon monoxide can cause severe nausea, fainting, or death.** Carbon monoxide is a poisonous gas present in exhaust gases. Carbon monoxide is an odorless, colorless, tasteless, nonirritating gas that can cause death if inhaled for even a short time. Carbon monoxide poisoning symptoms include but are not limited to the following:

- Light-headedness, dizziness
- Physical fatigue, weakness in joints and muscles
- Sleepiness, mental fatigue, inability to concentrate or speak clearly, blurred vision
- Stomachache, vomiting, nausea

If experiencing any of these symptoms and carbon monoxide poisoning is possible, seek fresh air immediately and remain active. Do not sit, lie down, or fall asleep. Alert others to the

possibility of carbon monoxide poisoning. Seek medical attention if the condition of affected persons does not improve within minutes of breathing fresh air.

**Carbon monoxide detectors. Carbon monoxide can cause severe nausea, fainting, or death.** Install carbon monoxide detectors on each level of any building adjacent to the generator set. Locate the detectors to adequately warn the building's occupants of the presence of carbon monoxide. Keep the detectors operational at all times. Periodically test and replace the carbon monoxide detectors according to the manufacturer's instructions.

**Fuel System**

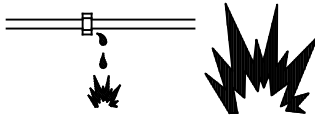
<b>⚠ WARNING</b>

<p><b>Explosive fuel vapors.</b>  <b>Can cause severe injury or death.</b></p> <p>Use extreme care when handling, storing, and using fuels.</p>

**The fuel system. Explosive fuel vapors can cause severe injury or death.** Vaporized fuels are highly explosive. Use extreme care when handling and storing fuels. Store fuels in a well-ventilated area away from spark-producing equipment and out of the reach of children. Never add fuel to the tank while the engine is running because spilled fuel may ignite on contact with hot parts or from sparks. Do not smoke or permit flames or sparks to occur near sources of spilled fuel or fuel vapors. Keep the fuel lines and connections tight and in good condition. Do not replace flexible fuel lines with rigid lines. Use flexible sections to avoid fuel line breakage caused by vibration. Do not operate the generator set in the presence of fuel leaks, fuel accumulation, or sparks. Repair fuel systems before resuming generator set operation.

**Explosive fuel vapors can cause severe injury or death.** Take additional precautions when using the following fuels:

**Propane (LPG)**—Adequate ventilation is mandatory. Because propane is heavier than air, install propane gas detectors low in a room. Inspect the detectors per the manufacturer’s instructions.

**Natural Gas**—Adequate ventilation is mandatory. Because natural gas rises, install natural gas detectors high in a room. Inspect the detectors per the manufacturer’s instructions.

**Gas fuel leaks. Explosive fuel vapors can cause severe injury or death.** Fuel leakage can cause an explosion. Check the LPG vapor or natural gas fuel system for leakage by using a soap and water solution with the fuel system test pressurized to 6–8 ounces per square inch (10–14 inches water column). Do not use a soap solution containing either ammonia or chlorine because both prevent bubble formation. A successful test depends on the ability of the solution to bubble.

## Hazardous Noise

**⚠ CAUTION**



**Hazardous noise.  
Can cause hearing loss.**

Never operate the generator set without a muffler or with a faulty exhaust system.

**Engine noise. Hazardous noise can cause hearing loss.** Generator sets not equipped with sound enclosures can produce noise levels greater than 105 dBA. Prolonged exposure to noise levels greater than 85 dBA can cause permanent hearing loss. Wear hearing protection when near an operating generator set.

## Hazardous Voltage/ Moving Parts

**⚠ WARNING**

**Hazardous voltage. Moving parts. Can cause severe injury or death.**

Operate the generator set only when all guards and electrical enclosures are in place.

**⚠ WARNING**

**Hazardous voltage. Backfeed to the utility system can cause property damage, severe injury, or death.**

If the generator set is used for standby power, install an automatic transfer switch to prevent inadvertent interconnection of standby and normal sources of supply.

**⚠ CAUTION**

**Welding the generator set. Can cause severe electrical equipment damage.**

Never weld components of the generator set without first disconnecting the battery, controller wiring harness, and engine electronic control module (ECM).

**Grounding electrical equipment. Hazardous voltage can cause severe injury or death.** Electrocutation is possible whenever electricity is present. Ensure you comply with all applicable codes and standards. Electrically ground the generator set, transfer switch, and related equipment and electrical circuits. Turn off the main circuit breakers of all power sources before servicing the equipment. Never contact electrical leads or appliances when standing in water or on wet ground because these conditions increase the risk of electrocution.

**Disconnecting the electrical load. Hazardous voltage can cause severe injury or death.** Disconnect the generator set from the load by turning off the line circuit breaker or by disconnecting the generator set output leads from the transfer switch and heavily taping the ends of the leads. High voltage transferred to the load during testing may cause personal injury and equipment damage. Do not use the safeguard circuit breaker in place of the line circuit breaker. The safeguard circuit breaker does not disconnect the generator set from the load.

**Welding on the generator set. Can cause severe electrical equipment damage.** Before welding on the generator set perform the following steps: (1) Remove the battery cables, negative (-) lead first. (2) Disconnect all engine electronic control module (ECM) connectors. (3) Disconnect all generator set controller and voltage regulator circuit board connectors. (4) Disconnect the engine battery-charging alternator connections. (5) Attach the weld ground connection close to the weld location.

**Connecting the battery and the battery charger. Hazardous voltage can cause severe injury or death.** Reconnect the battery correctly, positive to positive and negative to negative, to avoid electrical shock and damage to the battery charger and battery(ies). Have a qualified electrician install the battery(ies).

**Short circuits. Hazardous voltage/current can cause severe injury or death.** Short circuits can cause bodily injury and/or equipment damage. Do not contact electrical connections with tools or jewelry while making adjustments or repairs. Remove all jewelry before servicing the equipment.

**Engine block heater. Hazardous voltage can cause severe injury or death.** The engine block heater can cause electrical shock. Remove the engine block heater plug from the electrical outlet before working on the block heater electrical connections.

**Electrical backfeed to the utility. Hazardous backfeed voltage can cause severe injury or death.** Install a transfer switch in standby power installations to prevent the connection of standby and other sources of power. Electrical backfeed into a utility electrical system can cause severe injury or death to utility personnel working on power lines.

**⚠ WARNING**



**Airborne particles. Can cause severe injury or blindness.**

Wear protective goggles and clothing when using power tools, hand tools, or compressed air.

**Servicing the generator set when it is operating. Exposed moving parts can cause severe injury or death.** Keep hands, feet, hair, clothing, and test leads away from the belts and pulleys when the generator set is running. Replace guards, screens, and covers before operating the generator set.

## Heavy Equipment

**⚠ WARNING**



**Unbalanced weight. Improper lifting can cause severe injury or death and equipment damage.**

Do not use lifting eyes. Lift the generator set using lifting bars inserted through the lifting holes on the skid.

## Hot Parts

**⚠ WARNING**



**Hot coolant and steam. Can cause severe injury or death.**

Before removing the pressure cap, stop the generator set and allow it to cool. Then loosen the pressure cap to relieve pressure.

**⚠ WARNING**



**Hot engine and exhaust system. Can cause severe injury or death.**

Do not work on the generator set until it cools.

**Servicing the alternator. Hot parts can cause severe injury or death.** Avoid touching the alternator field or exciter armature. When shorted, the alternator field and exciter armature become hot enough to cause severe burns.

**Servicing the exhaust system. Hot parts can cause severe injury or death.** Do not touch hot engine parts. The engine and exhaust system components become extremely hot during operation.

## Notice

**NOTICE**

**Canadian installations only.** For standby service connect the output of the generator set to a suitably rated transfer switch in accordance with Canadian Electrical Code, Part 1.

**NOTICE**

**Electrostatic discharge damage.** Electrostatic discharge (ESD) damages electronic circuit boards. Prevent electrostatic discharge damage by wearing an approved grounding wrist strap when handling electronic circuit boards or integrated circuits. An approved grounding wrist strap provides a high resistance (about 1 megohm), *not a direct short*, to ground.



This manual provides operation instructions for Model 38RCL, 48RCL, 48RCLA, and 60RCL residential/light commercial generator sets equipped with the RDC2 generator set/transfer switch controller.

This generator set is approved for use in stationary applications in locations served by a reliable utility power source. Have the generator set installed by an authorized Kohler distributor/dealer or service technician. Refer to the Installation Manual for installation instructions.

Information in this publication represents data available at the time of print. Kohler Co. reserves the right to change this publication and the products represented without notice and without any obligation or liability whatsoever.

Read this manual and carefully follow all procedures and safety precautions to ensure proper equipment operation and to avoid bodily injury. Read and follow the Safety Precautions and Instructions section at the beginning of this manual. Keep this manual with the equipment for future reference.

The equipment maintenance requirements are very important for safe and efficient operation. Inspect the parts often and perform required maintenance at the prescribed intervals. Obtain service from an authorized Kohler distributor/ dealer or service technician to keep equipment in top condition.



**Figure 1** Model 48RCL Generator Set

## Nameplate

Figure 2 shows a typical generator set nameplate. Copy the model, serial, and specification numbers from the nameplate into the spaces provided in the product information section on the inside front cover of this manual. See the service view in Section 1 for the nameplate location.

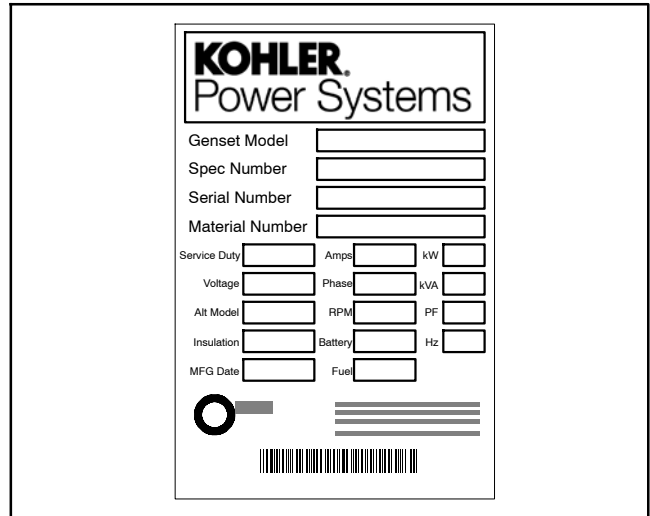

**Figure 2** Nameplate, Typical

## List of Related Literature

Figure 3 identifies related literature available for the generator sets covered in this manual. Only trained and qualified personnel should install or service the generator set.

Literature Type	Part Number
Specification Sheet, 38RCL	G4-214
Specification Sheet, 48RCL	G4-211
Specification Sheet, 48RCLA	G4-263
Specification Sheet, 60RCL	G4-233
Installation Manual, Generator Set	TP-6809
Operation Manual, Engine	TP-6101
Service Manual, Generator Set	TP-6811
Service Manual, 38RCL Engine Mechanical	TP-6103
Service Manual, 48RCL, 48RCLA, and 60RCL Engine Mechanical	TP-6104
Service Manual, Engine ECM Diagnostics	TP-6724
Service Manual, Alternator, 38RCL	TP-6353
Service Manual, Alternator, 48RCL, 48RCLA, and 60RCL	TP-6783
Parts Catalog, 38RCL Engine	TP-6730
Parts Catalog, 48RCL, 48RCLA, and 60RCL Engine	TP-6731
Parts Catalog, Generator Set	TP-6812
Installation Instructions, Load Shed Kit	TT-1609
Installation Instructions, Programmable Interface Module (PIM)	TT-1584
Installation Instructions, Power Relay Modules	TT-1646
User Guide, OnCue® Plus Software	TP-7006
Technical Manual, OnCue Plus Software	TP-7007
Operation/Installation Manual, RXT ATS	TP-6807
Operation/Installation Manual, RDT ATS	TP-6345

**Figure 3** Related Literature

# Service Assistance

---

For professional advice on generator set power requirements and conscientious service, please contact your nearest authorized Kohler distributor or dealer.

- Consult the Yellow Pages under the heading Generators—Electric.
- Visit the Kohler Power Systems website at KOHLERPower.com.
- Look at the labels and decals on your Kohler product or review the appropriate literature or documents included with the product.
- Call toll free in the US and Canada 1-800-544-2444.
- Outside the US and Canada, call the nearest regional office.

## **Headquarters Europe, Middle East, Africa (EMEA)**

Kohler Power Systems Netherlands B.V.  
Kristallaan 1  
4761 ZC Zevenbergen  
The Netherlands  
Phone: (31) 168 331630  
Fax: (31) 168 331631

## **Asia Pacific**

Power Systems Asia Pacific Regional Office  
Singapore, Republic of Singapore  
Phone: (65) 6264-6422  
Fax: (65) 6264-6455

## **China**

North China Regional Office, Beijing  
Phone: (86) 10 6518 7950  
(86) 10 6518 7951  
(86) 10 6518 7952  
Fax: (86) 10 6518 7955

East China Regional Office, Shanghai  
Phone: (86) 21 6288 0500  
Fax: (86) 21 6288 0550

## **India, Bangladesh, Sri Lanka**

India Regional Office  
Bangalore, India  
Phone: (91) 80 3366208  
(91) 80 3366231  
Fax: (91) 80 3315972

## **Japan, Korea**

North Asia Regional Office  
Tokyo, Japan  
Phone: (813) 3440-4515  
Fax: (813) 3440-2727

# Notes

# Section 1 Service Views

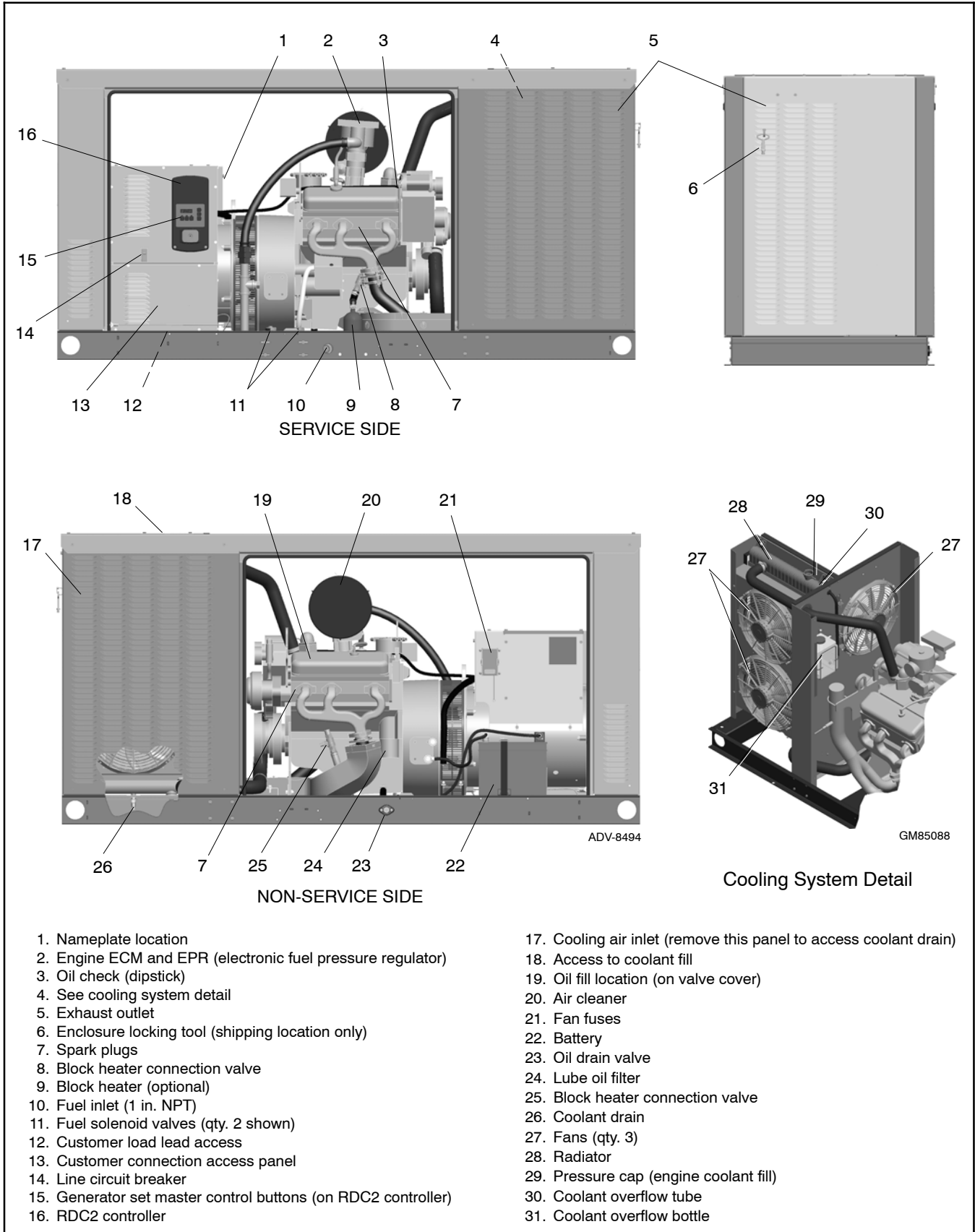

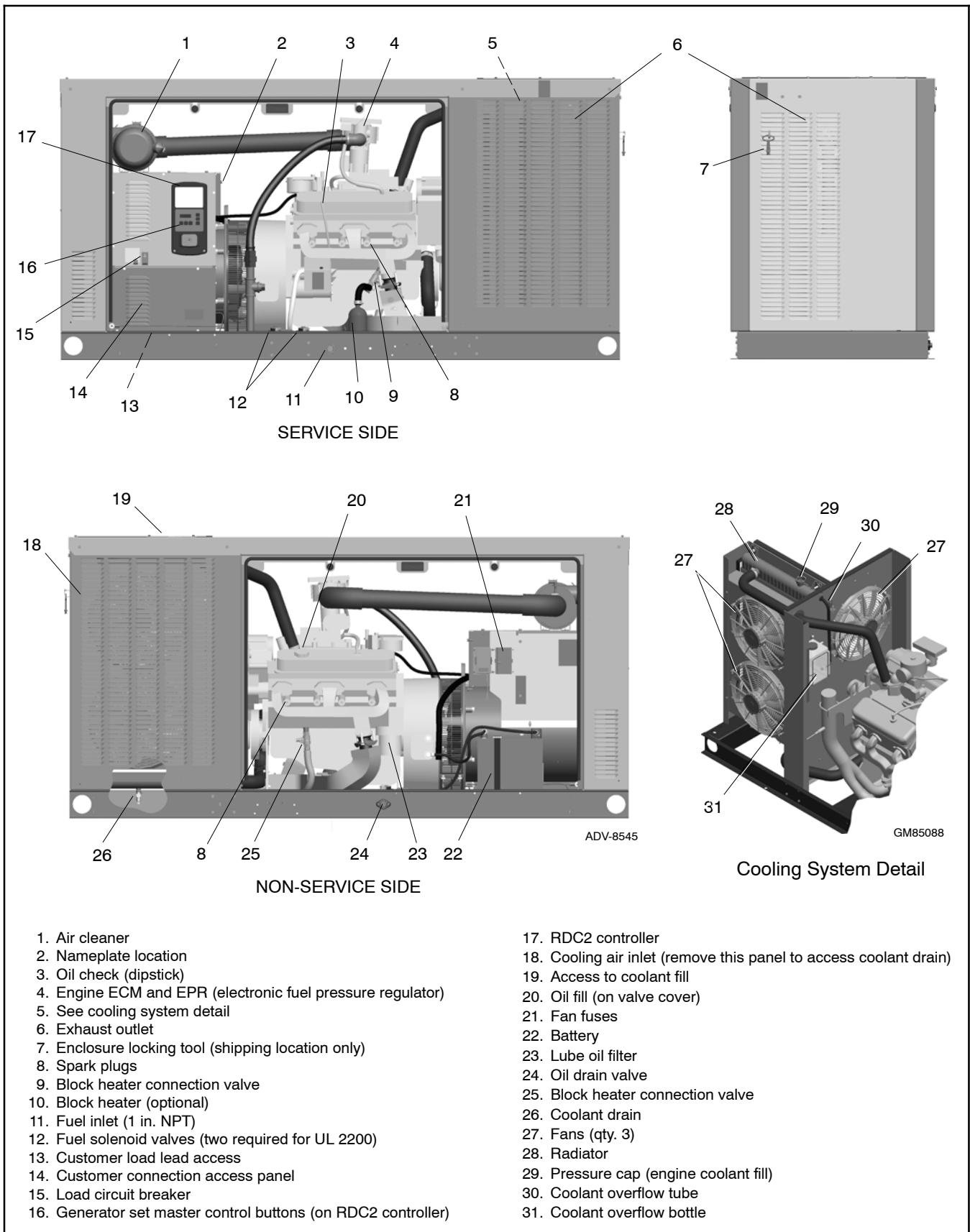

**Figure 1-1** Service Views, 38RCL, 48RCL (38RCL shown)



**Figure 1-2** Service Views, 48RCLA and 60RCL

## Section 2 Generator Set Operation

### 2.1 Operating Area

 <b>WARNING</b>

<b>Carbon monoxide.</b> <b>Can cause severe nausea, fainting, or death.</b>
The exhaust system must be leakproof and routinely inspected.

**Carbon monoxide symptoms. Carbon monoxide can cause severe nausea, fainting, or death.** Carbon monoxide is a poisonous gas present in exhaust gases. Carbon monoxide is an odorless, colorless, tasteless, nonirritating gas that can cause death if inhaled for even a short time. Carbon monoxide poisoning symptoms include but are not limited to the following:

- Light-headedness, dizziness
- Physical fatigue, weakness in joints and muscles
- Sleepiness, mental fatigue, inability to concentrate or speak clearly, blurred vision
- Stomachache, vomiting, nausea

If experiencing any of these symptoms and carbon monoxide poisoning is possible, seek fresh air immediately and remain active. Do not sit, lie down, or fall asleep. Alert others to the possibility of carbon monoxide poisoning. Seek medical attention if the condition of affected persons does not improve within minutes of breathing fresh air.

**Generator set operation. Carbon monoxide can cause severe nausea, fainting, or death.** Carbon monoxide is an odorless, colorless, tasteless, nonirritating gas that can cause death if inhaled for even a short time. Avoid breathing exhaust fumes when working on or near the generator set. Never operate the generator set inside a building. Never operate the generator set where exhaust gas could seep inside or be drawn into a potentially occupied building through windows, air intake vents, or other openings.

**Carbon monoxide detectors. Carbon monoxide can cause severe nausea, fainting, or death.** Install carbon monoxide detectors on each level of any building adjacent to the generator set. Locate the detectors to adequately warn the building's occupants of the presence of carbon monoxide. Keep the detectors operational at all times. Periodically test and replace the carbon monoxide detectors according to the manufacturer's instructions.

**Keep the generator set area clear.** Maintain at least 0.9 m (3 ft.) of clearance on all sides of the generator set. Verify that there are no windows, air vents, or other openings in the building within 1.5 m (5 ft.) of the generator set exhaust outlet in any direction.

#### Notice

Do not locate patios, decks, play areas, or animal shelters near the generator set. Keep items such as lawn furniture, toys, sports equipment, and all combustible materials away from the generator set exhaust outlet. Remind family members, children, and visitors to use caution near the generator set.

Generator sets connected to automatic transfer switches start automatically during exercise periods and power outages. Some generator set components become hot when the generator set is running and remain hot for a time after the generator set shuts down.

### 2.2 Prestart Checklist

#### WARNING

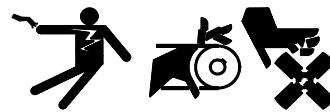

**Accidental starting.**  
**Can cause severe injury or death.**

Disconnect the battery cables before working on the generator set. Remove the negative (-) lead first when disconnecting the battery. Reconnect the negative (-) lead last when reconnecting the battery.

**Disabling the generator set. Accidental starting can cause severe injury or death.** Before working on the generator set or equipment connected to the set, disable the generator set as follows: (1) Press the generator set off/reset button to shut down the generator set. (2) Disconnect the power to the battery charger, if equipped. (3) Remove the battery cables, negative (-) lead first. Reconnect the negative (-) lead last when reconnecting the battery. Follow these precautions to prevent the starting of the generator set by the remote start/stop switch.

**⚠ WARNING**



**Sulfuric acid in batteries.  
Can cause severe injury or death.**

Wear protective goggles and clothing. Battery acid may cause blindness and burn skin.

**⚠ WARNING**



**Explosion.  
Can cause severe injury or death.  
Relays in the battery charger  
cause arcs or sparks.**

Locate the battery in a well-ventilated area. Isolate the battery charger from explosive fumes.

**Battery gases. Explosion can cause severe injury or death.** Battery gases can cause an explosion. Do not smoke or permit flames or sparks to occur near a battery at any time, particularly when it is charging. Do not dispose of a battery in a fire. To prevent burns and sparks that could cause an explosion, avoid touching the battery terminals with tools or other metal objects. Remove all jewelry before servicing the equipment. Discharge static electricity from your body before touching batteries by first touching a grounded metal surface away from the battery. To avoid sparks, do not disturb the battery charger connections while the battery is charging. Always turn the battery charger off before disconnecting the battery connections. Ventilate the compartments containing batteries to prevent accumulation of explosive gases.

**Battery electrolyte is a diluted sulfuric acid. Battery acid can cause severe injury or death.** Battery acid can cause blindness and burn skin. Always wear splashproof safety goggles, rubber gloves, and boots when servicing the battery. Do not open a sealed battery or mutilate the battery case. If battery acid splashes in the eyes or on the skin, immediately flush the affected area for 15 minutes with large quantities of clean water. Seek immediate medical aid in the case of eye contact. Never add acid to a battery after placing the battery in service, as this may result in hazardous spattering of battery acid.

**⚠ WARNING**



**Hazardous voltage. Moving parts.  
Can cause severe injury or death.**

Operate the generator set only when all guards and electrical enclosures are in place.

**Grounding electrical equipment. Hazardous voltage can cause severe injury or death.** Electrocutation is possible whenever electricity is present. Ensure you comply with all applicable codes and standards. Electrically ground the generator set, transfer switch, and related equipment and electrical circuits. Turn off the main circuit breakers of all power sources before servicing the equipment. Never contact electrical leads or appliances when standing in water or on wet ground because these conditions increase the risk of electrocution.

**Connecting the battery and the battery charger. Hazardous voltage can cause severe injury or death.** Reconnect the battery correctly, positive to positive and negative to negative, to avoid electrical shock and damage to the battery charger and battery(ies). Have a qualified electrician install the battery(ies).

**Short circuits. Hazardous voltage/current can cause severe injury or death.** Short circuits can cause bodily injury and/or equipment damage. Do not contact electrical connections with tools or jewelry while making adjustments or repairs. Remove all jewelry before servicing the equipment.

To ensure continued satisfactory operation perform the following checks or inspections before or at each startup, as designated, and at the intervals specified in the service schedule. In addition, some checks require verification after the unit starts.

**Air Cleaner.** Check for a clean and installed air cleaner element to prevent unfiltered air from entering the engine.

**Air Inlets.** Check for obstructions that could block the flow of cooling air. Keep the air intake area clean. Do not leave rags, tools, or debris on or near the generator set.

**Battery.** Check for tight battery connections. Consult the battery manufacturer's instructions regarding battery care and maintenance.

**Coolant Level.** Check the coolant level according to the cooling system maintenance information.



**Note: Block heater damage.** The block heater will fail if the energized heater element is not immersed in coolant. Fill the cooling system before turning on the block heater. Run the engine until it is warm, and refill the radiator to purge the air from the system before energizing the block heater.

**Drive Belt(s).** Check the belt condition of the water pump and battery charging alternator belt(s).

**Exhaust System.** Check for exhaust leaks and blockages. Check the silencer and piping condition and check for tight exhaust system connections.

Inspect the exhaust system components for cracks and corrosion (exhaust manifold, exhaust pipe, exhaust clamps, and silencer).

- Check for corroded or broken metal parts and replace them as needed.
- Check that there are no combustible materials near the exhaust outlet.
- Check that the exhaust outlet is unobstructed.

**Carbon Monoxide Detectors.** Check for the installation and operation of carbon monoxide (CO) detectors on each level of any building near the generator set.

**Oil Level.** Maintain the oil level at or near, not over, the full mark on the dipstick.

## 2.3 Exercising the Generator Set

Operate the generator set without load every week or every other week for 20 minutes. Perform all of the prestart checks before starting the exercise procedure. See Section 2.5 for instructions to set the automatic exerciser.

## 2.4 Generator Set Operation

### 2.4.1 Local Starting and Stopping

**Start:** Press the RUN button to immediately start the generator set.

**Stop:** Press the OFF button. The engine stops.

Run the generator set with no load for at least 2 minutes to ensure adequate engine cooldown.

### 2.4.2 Automatic Starting and Stopping

An automatic transfer switch monitors the utility power and signals the generator set to start when utility power is lost. The ATS then transfers the load to the generator set.

When utility power is restored, the transfer switch transfers the load back to utility, runs the generator set with no load to cool down the engine, and then stops the generator set engine. The electric fans continue to run for two minutes after the engine shuts down to evacuate the engine compartment.

### 2.4.3 Remote Starting and Stopping

A remote switch connected to terminals 3 and 4 can be used to start and stop the generator set. Close the switch to start and run the generator set. Open the switch to stop the generator set.

Run the generator set with no load for at least 2 minutes to ensure adequate engine cooldown.

### 2.4.4 Engine Start Crank Cycle

The controller attempts to start the generator set three times (three crank cycles, 15 seconds crank and 15 seconds off). If the generator set does not start in three attempts, the system shuts down on an overcrank fault. See Section 2.6.

Pressing the OFF button during the crank cycle stops the cranking. No other buttons are acknowledged during the crank cycle.

### 2.4.5 Engine Cooldown

The engine cooldown time delay allows the engine to run after the loads have been removed.

The engine cooldown time delay is set to 5 minutes. The engine stops before the cooldown time delay expires if the temperature drops below the cooled-down temperature level, or if the temperature rises above the high limit during the cooldown cycle.

The electric fans continue to run for two minutes after the engine shuts down to evacuate the engine compartment.

If a transfer switch other than the Model RXT is used, an additional engine cooldown time delay may be programmed on the transfer switch. To allow the smart engine cooldown on the RDC2 controller to operate most efficiently, set the cooldown time on the transfer switch controller to zero or the minimum time allowed. Refer to the instructions provided with the transfer switch for more information.

## 2.4.6 Automatic Operation with Model RXT Transfer Switch

The Model RXT transfer switch connects to the RDC2 controller through the ATS interface board on the transfer switch. Also see Section 2.7, Model RXT Transfer Switch Operation.

The RDC2 controller must be in AUTO mode for automatic transfer switch operation.

### Automatic Start

The RDC2 controller receives utility source voltage sensing data from the Model RXT transfer switch.

1. If the utility source voltage falls below an acceptable level, the controller starts the engine start time delay.
2. If the utility source is not restored before the time delay expires, the generator set starts.
3. After the Normal-to-Emergency time delay, the ATS is signaled to transfer the load to the emergency source.

### Automatic Stop

1. When the utility source is restored, the Emergency-to-Normal time delay starts.
2. When the Emergency-to-Normal time delay expires, the load is transferred to the utility.
3. The generator set stops.

## 2.4.7 Automatic Operation with Other Transfer Switches

If a Kohler Model RDT transfer switch is used, the engine start contacts from the ATS must be connected to engine start leads 3 and 4 on the generator set.

The RDC2 generator set controller must be in AUTO mode to respond to remote start/stop signals from an ATS or remote switch. Press the AUTO button on the RDC2 controller to put the generator set into automatic mode.

### Automatic Start

The engine start contacts on the ATS close to signal the generator set to start, and remain closed while the generator set is running.

### Automatic Stop

The engine start contacts on the ATS open to signal the generator set to stop.

## 2.5 Exercise

The RDC2 controller can be set to automatically run the generator set at the same time and day every week or every other week. Exercising the generator set every week or every two weeks is required in order to keep the engine and alternator in good operating condition.

Three exercise modes are available: unloaded cycle, unloaded full speed, and loaded full speed. See Sections 2.5.1 through 2.5.3 for information about the exercise modes. A loaded exercise can be set at the RDC2 controller only if a Model RXT transfer switch is connected.

**Note:** With the RDT transfer switches, it is possible to have two exercise settings (one unloaded exercise set at the generator set controller, and another exercise set at the ATS controller). If the exercise times overlap, the ATS exercise setting takes priority.

If a Model RDT transfer switch is used, refer to the instructions provided with the transfer switch to set a loaded exercise at the ATS, if desired.

### 2.5.1 Unloaded Cycle Exercise with Complete System Diagnostics

An unloaded cycle exercise runs the generator set without signalling the transfer switch to transfer the electrical load from the utility source to the generator set. The Unloaded Cycle exercise with diagnostics is the recommended exercise mode and is the factory-default exercise setting.

The Unloaded Cycle exercise runs the engine for 20 minutes in the cycle shown in Figure 2-1 and described below.

- Runs at reduced speed for 10 minutes to warm up and exercise the engine.
- Ramps up and runs at full speed for 3 minutes. Engine diagnostics are performed during this full-speed portion of the cycle, which provides the best test of engine and alternator power backup capability. Diagnostic tests at full speed can identify potential problems with the power output and alert the operator before an emergency event.

- Ramps down and runs at reduced speed for 5 minutes to cool down the engine before shutting down automatically.

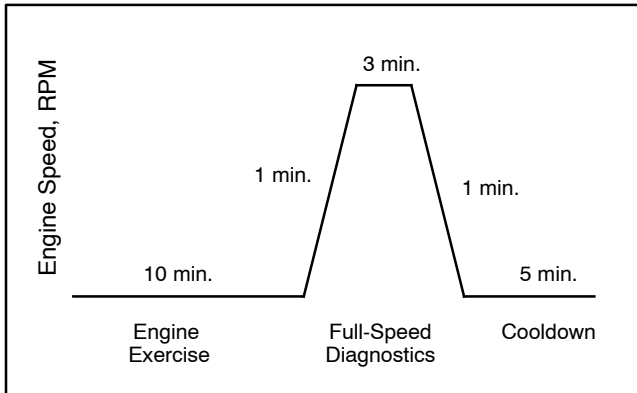

**Figure 2-1** Unloaded Exercise Cycle

### System Diagnostics

During the unloaded cycle exercise, the controller monitors the following data. The controller display indicates an unloaded exercise run during the diagnostics, unless a fault is detected as described below.

- **ATS connection.** The controller verifies that the Model RXT ATS interface board is connected.
- **Battery voltage.** Battery voltage is checked before exercise to verify engine starting capability. Battery voltage provides a measurement of battery health. If the controller detects low battery voltage, low battery or low charging battery is displayed and the exercise does not start.
- **Coolant level check.** The coolant level is checked.
- **Communication integrity tests.** J1939, RBUS, Ethernet, and USB are monitored for messages indicating that the controller and wiring are reliable.
- **Engine speed.** Engine speed is measured at low speed and full speed. An overspeed or underspeed condition will result in a fault condition and shutdown.
- **Generator output frequency and voltage.** Operating the generator at full speed allows the RDC2 controller to check the output power for correct voltage, frequency, and stability. When the engine is running at full speed, the controller verifies that the voltage and frequency are within acceptable limits. A fault message is displayed if the voltage or frequency is out of range.

- **Oil pressure.** Oil pressure is verified to ensure proper lubrication of critical engine components. Pressure is monitored at both low and full speeds. If the oil pressure is low, low oil pressure is displayed and the generator set shuts down.

### 2.5.2 Unloaded Full-Speed Exercise

The unloaded full speed exercise runs the generator set at full speed for 20 minutes without transferring the load.

To set an unloaded full speed exercise, follow the procedure in Figure 2-3 and select Exercise Mode: Unloaded Full.

### 2.5.3 Loaded Full-Speed Exercise (with RXT only)

A loaded exercise starts the generator set, ramps up to full speed, and then transfers the electrical load from the utility source to the generator set. The load is transferred back to the utility source before the generator set shuts down.

**Note:** With a loaded exercise, power to the building is lost for up to 10 seconds during load transfer.

For a loaded exercise controlled by the RDC2 controller, a Model RXT transfer switch must be connected to the generator set. To set a loaded exercise, follow the procedure in Section 2.5.8 and select Exercise Type: Loaded.

For a loaded exercise with a transfer switch other than a Kohler® Model RXT, program the exercise at the transfer switch controller. Refer to the transfer switch operation manual for instructions.

### 2.5.4 Shutdown During Exercise

The following advanced diagnostic operation applies to RDC2 controllers with firmware versions 5.04 and higher.

If the generator set shuts down on a fault during an exercise, the controller will try to restart the engine. If the engine starts, the generator set will run at full speed for two minutes and then stop. The event history will show Advanced Diagnostic Active. The exercise schedule is maintained.

If the engine does not start, the shutdown message will be displayed. Correct the fault condition and reset the fault as described in Section 2.6.

## 2.5.5 Power Failure During Exercise

If the utility power is lost during an unloaded exercise, the ATS transfers to the emergency source, the exercise is ended and the control remains in the AUTO mode.

If the utility power is lost during a loaded exercise, the exercise is ended. The ATS remains in the emergency position and the control goes into the AUTO mode.

The generator set continues to run and supply power to the load for the duration of the utility power outage. When Utility power is restored, the ATS will re-transfer to the utility source through normal timing sequences.

## 2.5.6 Exerciser Reset

To reset the exerciser to run at a different day and/or time or to change the exercise mode, follow the procedure in Section 2.5.7 to change the exerciser settings.

## 2.5.7 Setting the Exerciser at Power-up

When power is connected to the controller, you will be prompted to set the date, time, and exercise schedule.

1. At power-up, the date is displayed with the year flashing. Use the up or down arrow key to step to the current year.
2. Press Select button to save the year and move to the month.
3. Use the arrow and select buttons to set the month and the day.
4. The time is displayed with the hour flashing. Use the up or down arrow key to step to the current hour and am or pm setting.

**Note:** Check the am/pm setting displayed. If pm is displayed and you need to change it to am, use the down arrow button to step down in time until the correct hour and am are displayed.

5. Press the Select button to save the hour and move to minutes.
6. Use the up or down arrow button to change the minutes.
7. Press Select to save the time and move to the next screen.
8. Next Exercise is displayed. Use the up, down, and select buttons to set the exercise time and date. Be sure to set a time and date in the future.

9. Press Select. The controller exits the exercise menu.
10. Press the Auto button and verify that the AUTO LED is lit. The generator set must be in automatic mode for the exercise to run as scheduled.

The exercise will run every 7 days at the same time, starting on the date set. To change the exerciser to run every other week or on a different day and time, use the following procedure.

## 2.5.8 Changing the Exercise Setting

Set the date and time on the controller before setting the exercise schedule. Set the exerciser to automatically run the generator set for 20 minutes every week or every two weeks. Follow the procedure below and see the flowchart in Figure 2-3 to set the exercise time and date, mode, and frequency.

### Procedure to Change the Exercise Setting

1. Press the AUTO button on the controller.
2. Press the Select button to go to the main menu. See Figure 2-2.
3. Press the down arrow button to step to the Genset System menu.
4. Press the Select button to enter the Genset system menu. See Figure 2-3.
5. Use the down arrow button to step to the next Exercise menu.
6. Press the Select button. The setting flashes to show that it can be changed. For example, the hour flashes to show that the hour can be changed.
7. Press the UP or Down arrow buttons to change the setting.
8. Press the Select button to save the setting and move to the next. For example, save the hour setting and move to minutes.
9. Repeat steps 5 through 8 to change the next item on the line until the desired settings are displayed.
10. Press Select to save after all settings have been selected. Settings will stop flashing.
11. If the generator set is connected to a Kohler® Model RXT transfer switch, the exercise can be changed to a loaded exercise. Set the Exercise Mode to loaded full speed, unloaded full speed, or unloaded cycle as shown in Figure 2-3.

12. Set the exercise frequency (weekly or every two weeks). Weekly exercises are recommended.
13. Press the down arrow button to step to the Return menu. Press the Select button to return to the main menu.
14. Check that the AUTO LED is lit. The generator set must be in automatic mode for the exercise to run as scheduled.

After a scheduled exercise run, the next exercise time and date will be updated automatically based on the Exercise Frequency setting.

**Other transfer switches:** For a loaded exercise with a transfer switch other than a Kohler® Model RXT, program the exercise at the transfer switch controller. Refer to the transfer switch operation manual for instructions.

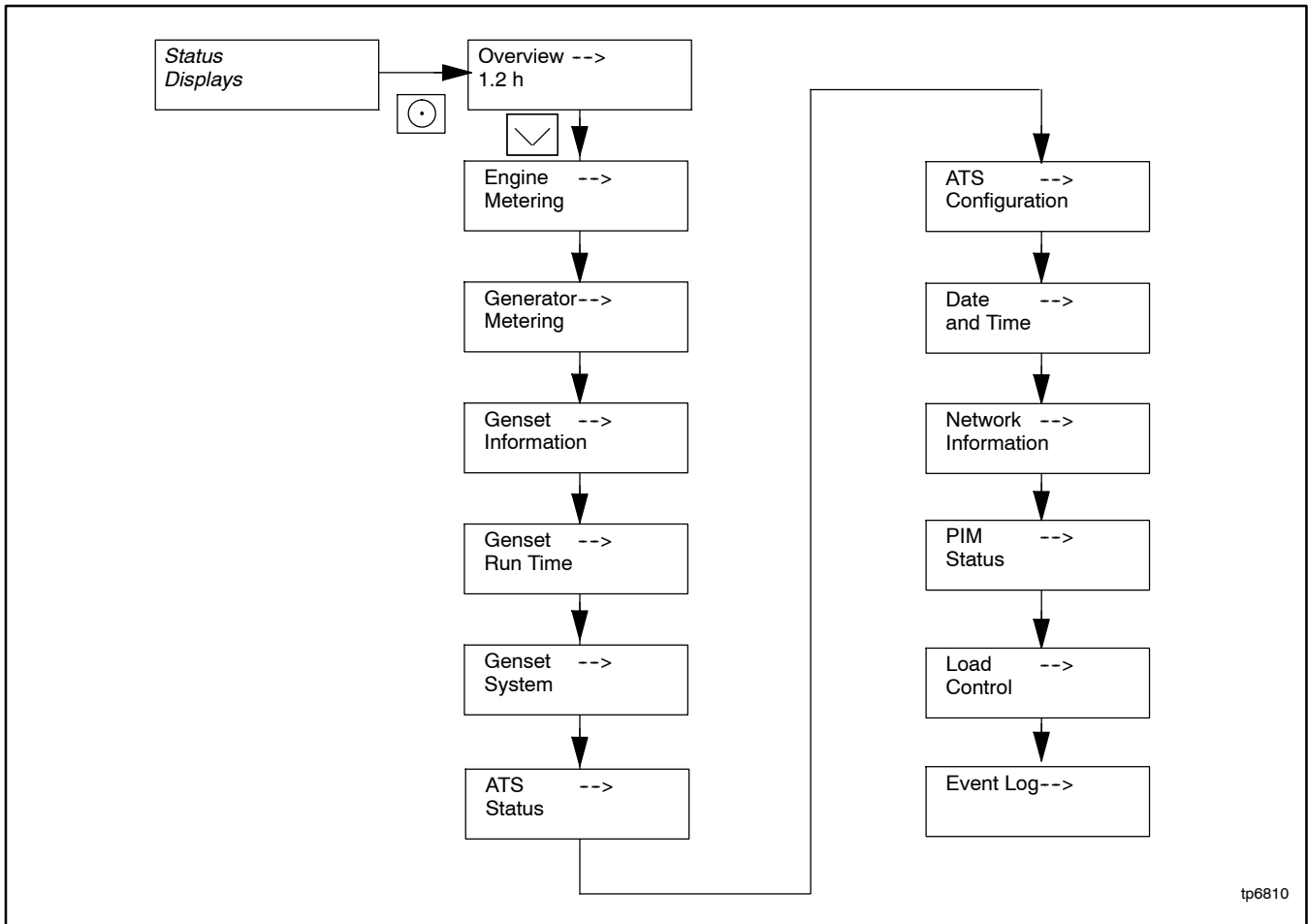

tp6810

**Figure 2-2** RDC2 Main Menu

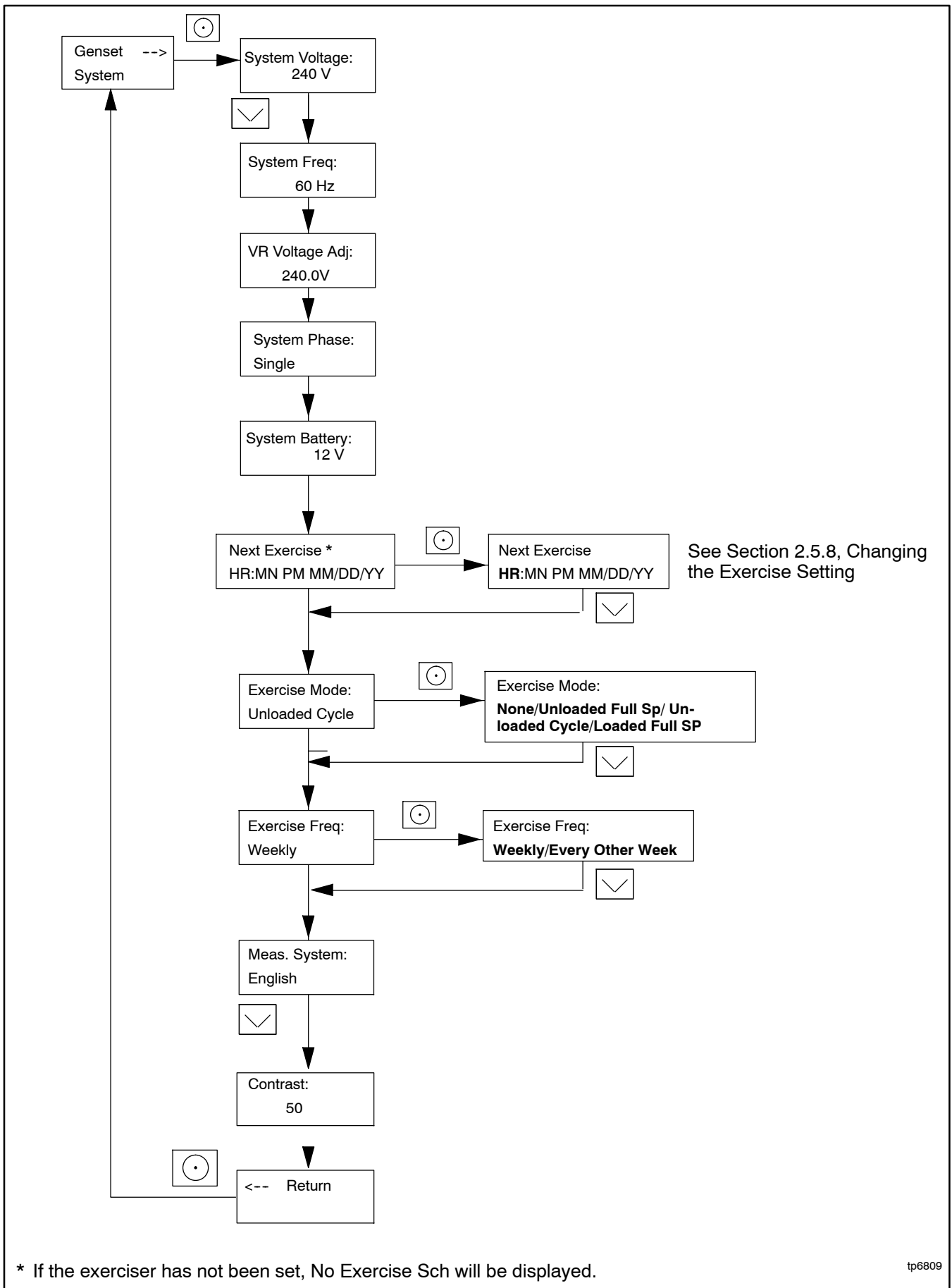

**Figure 2-3** Procedure to Set the Exerciser

## 2.6 Faults

Selected fault conditions are shown in Figure 2-5. Fault conditions are classified as warnings or shutdowns. If a fault occurs that is not listed in the table, contact an authorized distributor/dealer for service.

If a programmable interface module (PIM) is connected to the generator set controller, additional faults can be activated by customer-supplied equipment. See TT-1584, Installation Instructions for the Programmable Interface Module, for available inputs and outputs.

### 2.6.1 Warnings

The controller displays a fault message but the generator set does not shut down on a warning. The controller resets automatically after a warning condition is corrected.

### 2.6.2 Shutdowns

Under a fault shutdown condition, the generator set shuts down automatically and the controller displays a fault message. The OFF LED flashes. See Figure 2-5.

Shutdown switches (such as the low coolant level switch or high engine temperature switch) on the generator set will automatically reset when the problem is corrected. However, the fault condition at the controller does not clear until the controller is reset.

The generator set cannot be restarted until the fault condition is corrected and the controller is reset. See Section 2.6.4 to reset the controller after a fault shutdown.

### 2.6.3 ATS Communication Errors

When a Model RXT transfer switch is used, an ATS fault indicates that the connection to the interface board on

the transfer switch has been lost. Check the connection to the ATS interface board.

### 2.6.4 Resetting the Controller after a Fault Shutdown

Always identify and correct the cause of a fault shutdown before resetting the controller. Check the fault message displayed on the controller and refer to Figure 2-5 to identify and correct the fault condition before proceeding. Contact an authorized distributor/dealer for service, if necessary.

Press the OFF button to reset the controller, or follow the procedure below. See Figure 2-4.

#### Procedure to Reset the Controller after a Fault Shutdown

1. Press the Select button to go to the Overview menu.
2. Press Select again. The active fault is displayed.
3. Press Select. Confirm Clear Fault: NO is displayed.
4. Press the Up arrow button. Confirm Clear Fault: YES is displayed.
5. Press the Select button to enter YES and clear the fault.
6. Press the Select Button to return to the overview menu.
7. Press AUTO to put the generator set into automatic mode.

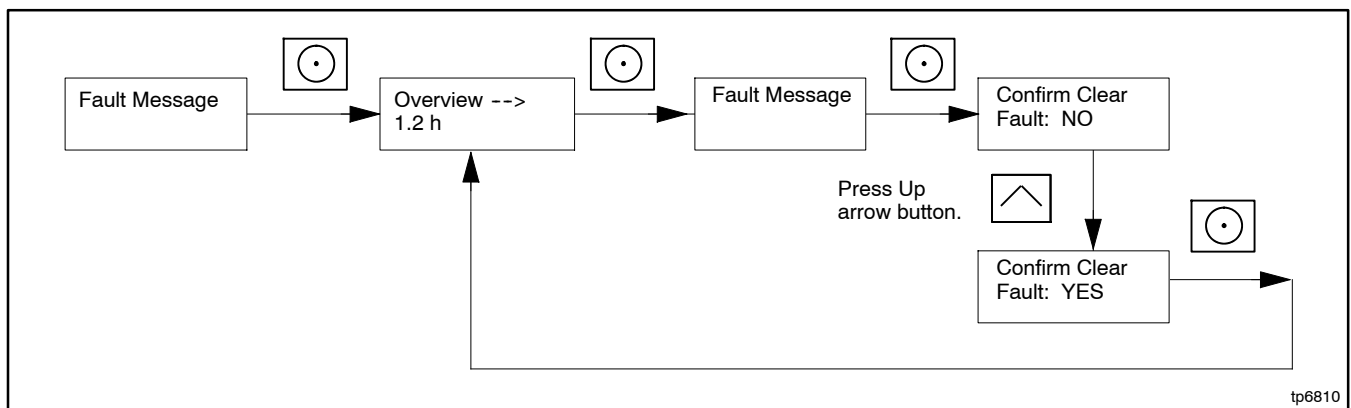

Figure 2-4 Clearing a Fault

Fault	Warning (W) or Shutdown (SD)	Condition	Check
AC Sens Lost	W (1 sec.) SD (3 sec.)	AC Sensing Lost. In Auto mode, generator output AC sensing is lost. Starts 10 seconds after crank disconnect.  Warning: after 1 second if no output detected after crank disconnect.  Shutdown: after 3 seconds if voltage was present and then lost.	Contact an authorized distributor/dealer for service.
Accy PwrOver Warning	W	Accessory Power Overload. An over current fault (short circuit) on the accessory controller power output.	Contact an authorized distributor/dealer for service.
Alt Protect Shtdwn	SD	High generator current has been detected. The generator set shuts down to protect the alternator from damage caused by overheating the windings. (38RCL only)	Reduce the load.
ATS Com Error	W	Ats Communication Error. Warning is displayed if RXT interface connection is lost. See Section 2.6.3.	Check communication wiring between transfer switch interface board and generator set.
ATS PhaseRot	W	ATS Phase Rotation Mismatch. Transfer switch phase rotation does not match. ATS will not transfer.	Correct the ATS connection. Refer to the ATS Installation manual, wiring diagrams, and labels on the transfer switch.
Aux Input	SD	Auxiliary Input. An optional customer-connected input is closed. (Digital input from optional PIM.)	Check customer-supplied equipment.
Batt Chg Flt	W	Battery charger fault. Input to PIM from an external battery charger (not the built-in battery charger).	Check external battery charger.
Battery Voltage High	W	Engine starting battery voltage rises above 125% of the battery voltage setting for more than 10 seconds. Inhibited during the engine crank cycle.  Clears when the battery voltage returns to an acceptable level.	Check the battery rating and condition.  Check the battery charger operation.
Battery Voltage Low	W	Engine starting battery voltage falls below the battery voltage setting (typically 12.5 volts) for more than 90 seconds when the engine is not running. Inhibited during the engine crank cycle.  Clears when the battery voltage returns to an acceptable level.	Check the battery rating and condition.  Check the battery charger operation.  Charge or replace the battery.
CAN comm fault	SD	Engine CAN communications fault.	Check wiring to ECM.  Check power to ECM.
Engine Coolant Temperature High	SD	Engine coolant temperature exceeds the maximum temperature for more than 5 seconds. Function becomes active after crank disconnect.	Check for blocked air inlets and exhaust outlets.
Engine Oil Pressure Low	SD	The engine ECM indicates low oil pressure for more than 5 seconds. Function becomes active 30 seconds after crank disconnect (30 second inhibit).  <b>Note:</b> The low oil pressure shutdown does not protect against low oil level. Check the engine oil level regularly as recommended in Section 4.	Check for leaks in the lubrication system.  Check the oil level and add oil if the level is low.
EngineSpeed High	SD	Engine speed exceeds 115% of the normal running speed for more than 0.3 seconds.	Contact an authorized distributor/dealer for service.
EngineSpeed Low	SD	Engine speed drops below 85% of the normal running speed for more than 3 seconds.	Reduce the load.  Contact an authorized distributor/dealer for service.



<b>Fault</b>	<b>Warning (W) or Shutdown (SD)</b>	<b>Condition</b>	<b>Check</b>
Exer Not Sch	W	Exercise Not Scheduled. No exercise has been scheduled on the RDC2 controller.	See Section 2.5 for instructions to set the exerciser.
Generator Frequency High	SD	Governed frequency exceeds 110% of the system's frequency setpoint for more than 10 seconds. Function becomes active 10 seconds after engine start (10 second inhibit).	Contact an authorized distributor/dealer for service.
Generator Frequency Low	SD	Governed frequency falls below 90% of the system frequency setting for more than 10 seconds, or 1 Hz below the system frequency setting for more than 60 seconds. Function becomes active 10 seconds after engine start (10 second inhibit).	Reduce the load and restart the generator set. Contact an authorized distributor/dealer for service.
Generator VoltageL1-L2 High	SD	Generator Voltage High. Output voltage exceeds 120% of the system nominal voltage for more than 2 seconds.	Contact an authorized distributor/dealer for service.
Generator VoltageL1-L2 Low	SD	Generator Voltage Low. Output voltage falls below 80% of the nominal system voltage for more than 10 seconds.	Reduce the load and restart the generator set. Contact an authorized distributor/dealer for service.
Lo Crank Vlt	W	Low cranking voltage. Battery voltage falls below 60% of system battery voltage for more than 6 seconds while the starter is engaged.	Charge or replace the battery.
Locked Rotor	SD	No engine rotation is sensed during cranking. Shuts down 3 seconds after the fault is detected.	Check the battery. Check for loose connections. Contact an authorized distributor/dealer for service.
MainPwrOverL Shutdown	SD	Main power overload. An over current fault on the 70 controller power output (short circuit).	Contact an authorized distributor/dealer for service.
Not in Auto	W	The generator set is not in Automatic (standby) mode. Remote start and stop commands from a transfer switch or remote switch will be ignored.	Press AUTO to place the generator set in Automatic mode, when appropriate.
Over Crank	SD	Three unsuccessful starting attempts.	Check the fuel supply, spark plug, and battery. Check for loose connections. Contact an authorized distributor/dealer for service.
Speed Sensor Fault	SD	Engine speed sensor has failed or engine stalled.	Contact an authorized distributor/dealer for service.
Total Power High ShtDwn	SD	Measured load is greater than 102% of the generator set power rating for more than 1 minute. (38RCL only)	Reduce the load.

**Figure 2-5** Controller Fault Messages

## 2.6.5 Event Log

The event log displays up to 1000 controller faults and notices, starting with the most recent event. Events are numbered 1-1000, with 1 being the most recent. Each event is displayed with the date and time of the event, the number of the event, a code to indicate whether the event was a warning (W), shutdown (S), or informational notice (I), the engine hours at the time of the event, and the event description.

### Procedure to View Event History

1. Press Select to enter the main menu.
2. Press the down arrow to step down to the event log.
3. Press Select to display the most recent event.
4. Press the down arrow to step to the next event.
5. Use the up and down arrow buttons to view events.
6. Press the Select button to exit the event log.

To stop viewing the event history before the last event, press the select button to return to the main menu.

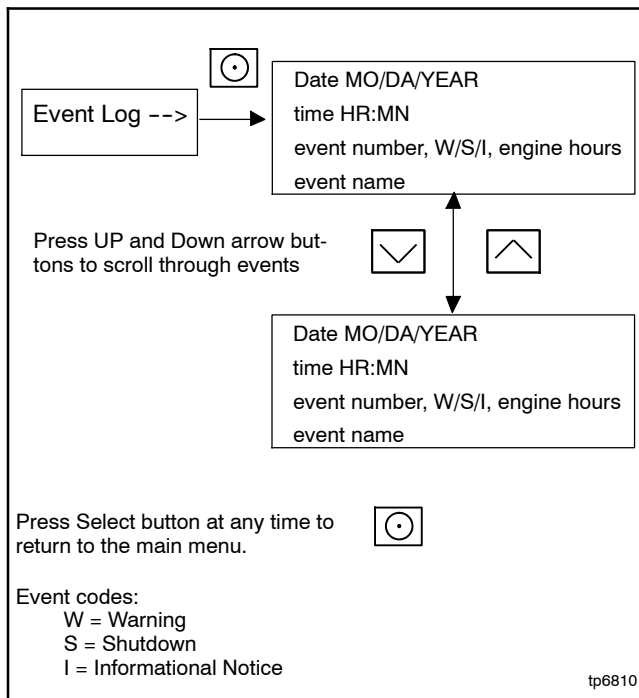

**Figure 2-6** Event Log

## 2.7 Model RXT Transfer Switch Operation

The RDC2 generator set/transfer switch controller manages automatic transfer switch (ATS) functions when connected to a Kohler® Model RXT transfer switch through the ATS interface board. Refer to the Model RXT Operation/Installation Manual for information about the transfer switch operation.

### 2.7.1 Source Availability

The Model RXT transfer switch supplies voltage sensing data to the RDC2 controller through the ATS interface board. If the source voltage falls below the undervoltage dropout setting, the source is considered to have failed. See Figure 2-7.

Item	Setting
Accuracy	± 5%
Undervoltage Dropout	90% of Pickup
Undervoltage Pickup	90% of Nominal

**Figure 2-7** Voltage Sensing Parameters

The RDC2 controller also has a set of power system LEDs below the pushbuttons. The power system LEDs indicate which power sources are available and which source is supplying power to the building. See Figure 3-1.

**Note:** The power system LEDs operate only if a Model RXT transfer switch is connected. They will not operate if a Model RDT transfer switch is used.

## 2.7.2 ATS Control Sequence of Operation

See Figure 2-8 for time delay settings.

### Preferred Source Fails:

1. The load control contact opens.
2. The engine start time delay times out.
3. The generator set is signaled to start.
4. The generator starts and the emergency source becomes available.
5. The normal-to-emergency time delay times out.
6. The transfer switch transfers to the emergency source.
7. The load control contact time delay times out.
8. The load control contact closes.

### Normal Source Returns:

1. The emergency-to-normal time delay times out.
2. The contactor transfers to the normal source.
3. The engine cooldown time delay times out.
4. The generator is signaled to stop.

## 2.7.3 Time Delays

Time delays are factory-set to the values shown in Figure 2-8. An authorized distributor/dealer can adjust time delays using a personal computer and Kohler® SiteTech™ software.

Time delays described in this section operate only when the controller is connected to a Kohler® Model RXT transfer switch.

The engine start and load transfer time delays prevent engine start and load transfer caused by brief variations in the utility power source.

## 2.7.4 ATS Load Control Relay Time Delay

The load control time delay allows delayed starting of large motor loads (such as air conditioners), preventing simultaneous starting of large motors after transfer to the generator set. The load control time delay is fixed at 5 minutes. It is not adjustable.

The load must be connected to the load control output on the interface board of the Model RXT transfer switch. See the transfer switch operation and installation manual for connection instructions.

Time Delay	Setting	Description
Engine Start	3 seconds	Time delay after utility source is lost until the engine start cycle begins. Guards against starting the generator set because of a brief change in the utility source.
Transfer, Normal to Emergency	3 seconds	Time delay after emergency source becomes available until transfer to emergency source.
Transfer, Emergency to Normal	2 minutes	Time delay after the utility source returns until transfer back to normal. Ensures that the utility source is stable before transferring from the emergency source.
Load Control	5 minutes	See Section 2.7.4. Allows delayed connection of selected loads to the generator set to prevent simultaneous starting of large motors after transfer to the emergency source. Recommended for delayed starting of air conditioners.

**Figure 2-8** Time Delays

# Notes

## Section 3 RDC2 Controller Operation

### 3.1 RDC2 Generator Set/Transfer Switch Controller

Model 38RCL, 48RCL, 48RCLA and 60RCL generator sets are equipped with the RDC2 generator set/transfer switch controller. The RDC2 controls the following power system components:

- Generator set
- Model RXT automatic transfer switch (ATS)
- Load management device
- Programmable interface module (PIM)

RDC2 Controller features include:

- Two-line x 16 character backlit LCD display with adjustable contrast
- OFF, AUTO, and RUN generator set master control buttons
- Generator set status indicating LEDs (OFF, AUTO, RUN)
- Up, Down, and Select buttons for navigation through menus and adjustments
- Power system indicator LEDs to show utility and generator source status, and to show which source (utility or generator) is supplying power to the building

### 3.2 Controls and Indicators

Figure 3-1 illustrates the keypad, display, and indicators on the controller's user interface.

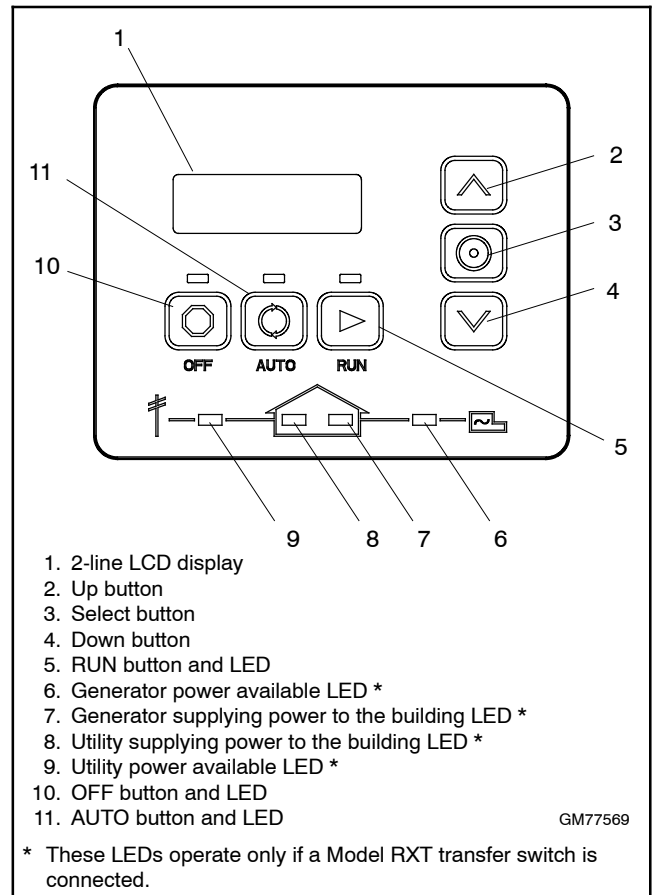

Figure 3-1 RDC2 User Interface

### 3.2.1 Controller Keypad

The Run, Off, and Auto buttons control the generator set as described in Figure 3-2. Use the Select, Up arrow, and Down arrow buttons to navigate through the menus and change settings, if necessary. See Section 2.4 for operation instructions.

### 3.2.2 LED Indicators

LEDs above the RUN, OFF, and AUTO buttons indicate the mode of operation as shown in Figure 3-2.

The RDC2 controller also has a set of power system LEDs below the pushbuttons. The power system LEDs indicate which power sources are available and which source is supplying power to the building (based on the position of the Model RXT transfer switch). See Figure 3-1.

**Note:** The power system LEDs operate only if a Model RXT transfer switch is connected. They will not operate if a Model RDT transfer switch is used.

Button	Button Function
RUN	Starts the generator set. The engine start time delay is ignored.
OFF	Stops the generator set. The cooldown time delay is ignored. During the engine crank cycle, pressing OFF will stop the crank cycle. Press OFF to clear faults and reset the controller.
AUTO	Places the generator set in Automatic (standby) mode.
Down arrow	Use to navigate through menus and change settings. This manual contains instructions to navigate the controller menus and adjust settings on the RDC2 controller.
Select	
Up arrow	

**Figure 3-2** Pushbutton Operation

LED	LED Operation
RUN	Lights when the generator set has been started locally by pressing the RUN button. Remote start and stop commands are ignored.
OFF	Lights for 2 seconds, then flashes every 2 seconds when the generator set and controller are off. Remote start/stop commands have no effect. The exercise cycle will not run. In Auto mode, OFF LED flashes quickly to indicate a fault shutdown. Attention required. Identify and correct the fault condition before resetting the controller.
AUTO	Lights when the generator is in automatic (standby) mode. Generator set will respond to engine start and stop commands from the controller (for example, exercise start and stop commands), an ATS, or OnCue® Plus. Time delays operate as described in Section 2.4.
Utility Power Available *	Lights when utility power is available.
Building on Utility Power *	Lights when the building load is connected to utility power through the RXT transfer switch.
Generator Power Available *	Lights when generator power is available.
Building on Generator Power *	Lights when the building load is connected to generator power through the RXT transfer switch.

\* These LEDs operate only if a Model RXT transfer switch is connected.

**Figure 3-3** RDC2 Controller LED Operation

### 3.2.3 LCD Display

The controller is equipped with a two-line x 16 character backlit liquid crystal diode (LCD) display with adjustable contrast. When the generator is running, the controller automatically scrolls through the displays shown in Figure 3-4. When the system is in AUTO, the LCD display scrolls through the status messages shown in Figure 3-5.

When a fault or warning condition exists, the controller will show the corresponding message. See Section 2.6 for more information on fault and warning messages.

Controller menus display power system information, including status information for the engine, generator, and optional RBUS accessories, exercise settings, and event history. Some menus allow changes to the controller settings. See Sections 3.6 through 3.19 for menu diagrams.

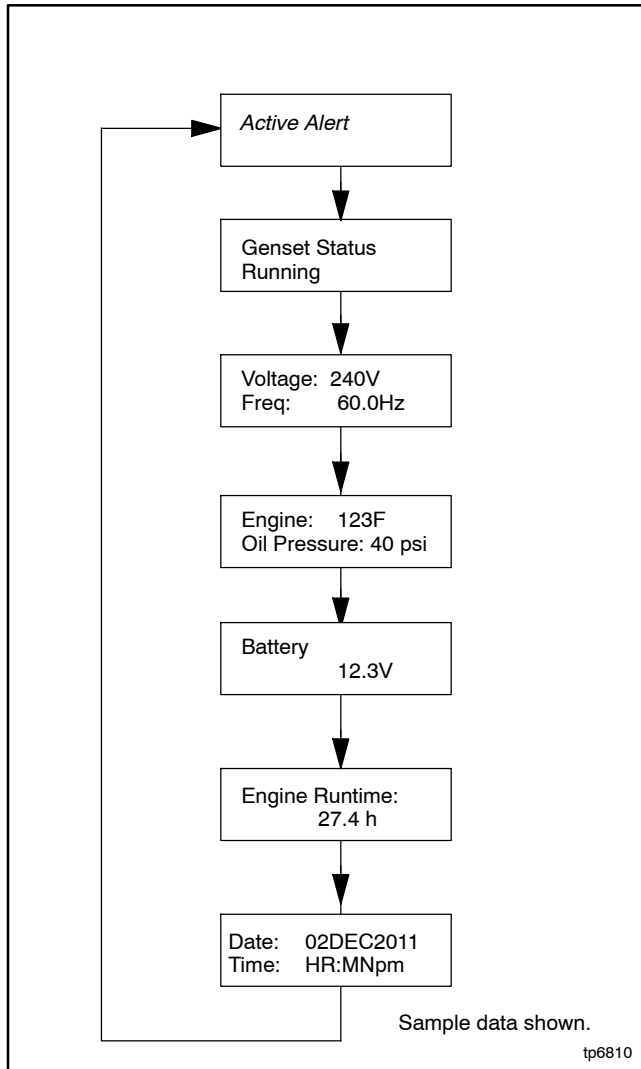

**Figure 3-4** Autopaging Displays, Generator Running

The display contrast is adjustable. Navigate to the Genset System menu and step down to the Contrast screen. Press the Select button, and then use the up and down arrow buttons to adjust the contrast. See Section 3.5, Changing Settings, and Section 3.11, Generator Set System Menu.

The display backlight turns off after about a minute of no activity. The backlight turns on when a button is pressed or when the generator set starts.

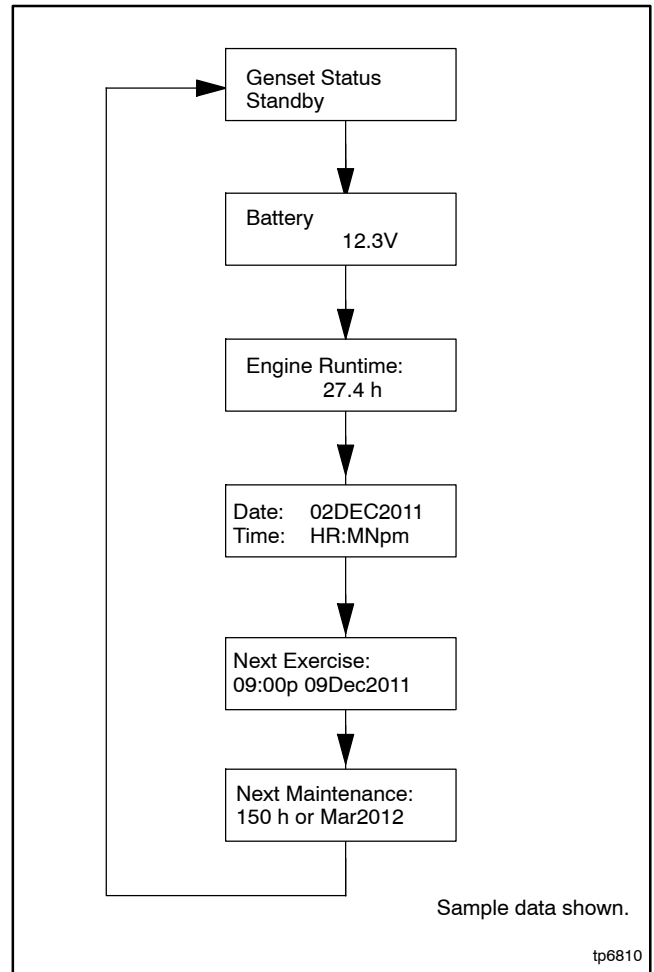

**Figure 3-5** Autopaging Displays, Automatic Mode

### 3.3 Controller Power

The RDC2 controller is powered by the generator set engine starting battery and the built-in battery charger.

**Note:** To disconnect controller power, disconnect the battery and the utility power to the generator set.

If controller power is disconnected and reconnected, you will be prompted to set the time, date, and exerciser. The first setting will flash. Press the Up and Down arrow buttons to change the setting. Press Select to save the setting and move on to the next. Repeat until all settings are saved and the controller returns to the main menu. See Section 3.5 for more detailed instructions to change settings on the RDC2. See Section 2.5 for more detailed instructions to set the exerciser or change the exercise settings.

### 3.4 Battery Charging

The controller includes a built-in battery charger to maintain the engine starting battery. The RDC2 controller monitors the battery voltage and provides a constant  $14 \pm 2\%$  VDC voltage and maximum 2.5 amps to charge the battery.

The installer must connect 120 VAC/60Hz utility power provided from the building on a breaker-protected circuit for the built-in battery charger. See the Installation Manual for instructions to connect the utility power for the battery charger.

### 3.5 Changing Settings

Some settings can be changed from the controller keypad. The controller settings and generator set output are factory-set and should not require field adjustment under normal circumstances. Check and adjust the settings and/or output when:

- The controller has been replaced.
- The voltage requires adjustment for a particular application.
- Troubleshooting generator set problems.

Have controller setup and adjustment performed only by an authorized Kohler distributor/dealer or authorized representative.

The following procedure explains how to change settings. See Figure 3-6 for an example using the Date and Time settings.

**Note:** Use caution when navigating the controller menus and changing the settings. In some menus, pressing the Select button can enable editing of the controller settings. Changing some settings to incorrect values can adversely affect generator set operation or render the unit inoperable.

#### Procedure to Change Settings

1. Press the Select button to enter the main menu.
2. Press the down arrow button until the desired menu is displayed. The Date and Time menu is used for the example in Figure 3-6.
3. Press the Select button to enter the selected menu. See Figure 3-6.
4. Press the down arrow button to step through the parameters in the selected menu.
5. To change a setting, press the Select button. The selected setting flashes.
6. Press the up or down arrow buttons to increase or decrease the setting.
7. When the desired setting is shown, press Select. The value stops flashing. If there are additional adjustable settings on the screen, the next setting flashes. For example, in the date menu, the year, month, and day can be adjusted.
8. Repeat steps 5 through 7 for each setting on the screen.
9. Press the down arrow to step to the next screen.
10. To exit, press the down arrow button until Return is displayed. Press the Select button to exit the menu.
11. Press the AUTO or OFF button to exit the main menu.

**Note:** If no buttons are pushed, the controller exits the menus and returns to the generator set status display after 5 minutes.



## Changing Settings on the RDC2 Controller

1. Press the Select button to enter the main menu.



2. Press the down arrow button until the desired menu is displayed. See Figure 3-7. Date and Time are used for this example.



3. Press the Select button to enter the Date and Time menu.



4. To change the date and time settings, press the Select button again. The year will flash.



5. Press the up or down arrow buttons to change the year.

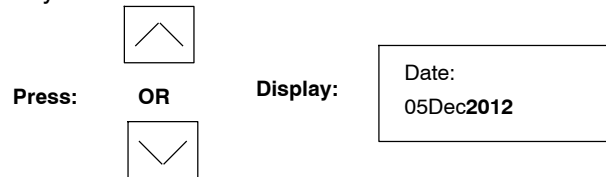

6. When the correct year is shown, press the Select button. The year is saved and the next setting (month) flashes.



7. Repeat steps 5 and 6, using the arrow and select buttons to set the month and the date.

8. When the correct date is shown, press the Select button. The saved date is shown.



9. Press the down arrow button to step to the next menu.



10. Repeat steps 5 and 6, using the arrow and select buttons to set and save the time.

**Note:** To change from am to pm, press the up arrow key to increase the hour until the correct hour and pm is displayed.

11. Repeat to set the time format to 12 hr. or 24 hr.

12. Press the down arrow button. Return is displayed.



13. Press Select to return to the Date and Time menu.



14. Press the Up or Down arrow buttons to step to a different menu.

15. Press Auto to signal the controller to exit the menus and return to the generator set status display.

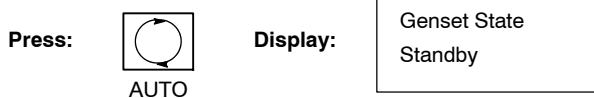

**Note:** If no buttons are pressed, the controller returns to the status display after 5 minutes.

**Figure 3-6** Changing Settings

### 3.6 Controller Menus

The following sections show the RDC2 controller menus and submenus. Use the Select button and the up and down arrow buttons to navigate the menus as shown in the diagrams.

**Note:** Use caution when navigating the controller menus. In some menus, pressing the Select button can enable editing of the controller settings. Changing the settings to incorrect values can adversely affect generator set operation or render the unit inoperable.

If a setting on the controller display is flashing, edit mode has been enabled. Press the OFF or AUTO button to exit the edit mode.

### 3.7 Main Menu

Press the Select button once to bring up the main menu. Overview is displayed. See Figure 3-7. Press the down arrow button to step to the next menu, Engine Metering. Use the UP and DOWN arrow buttons to step up and down through the menus shown in Figure 3-7.

The controller will exit the main menu after 5 minutes if no buttons are pressed. To exit the main menu immediately, press the controller's OFF or AUTO button.

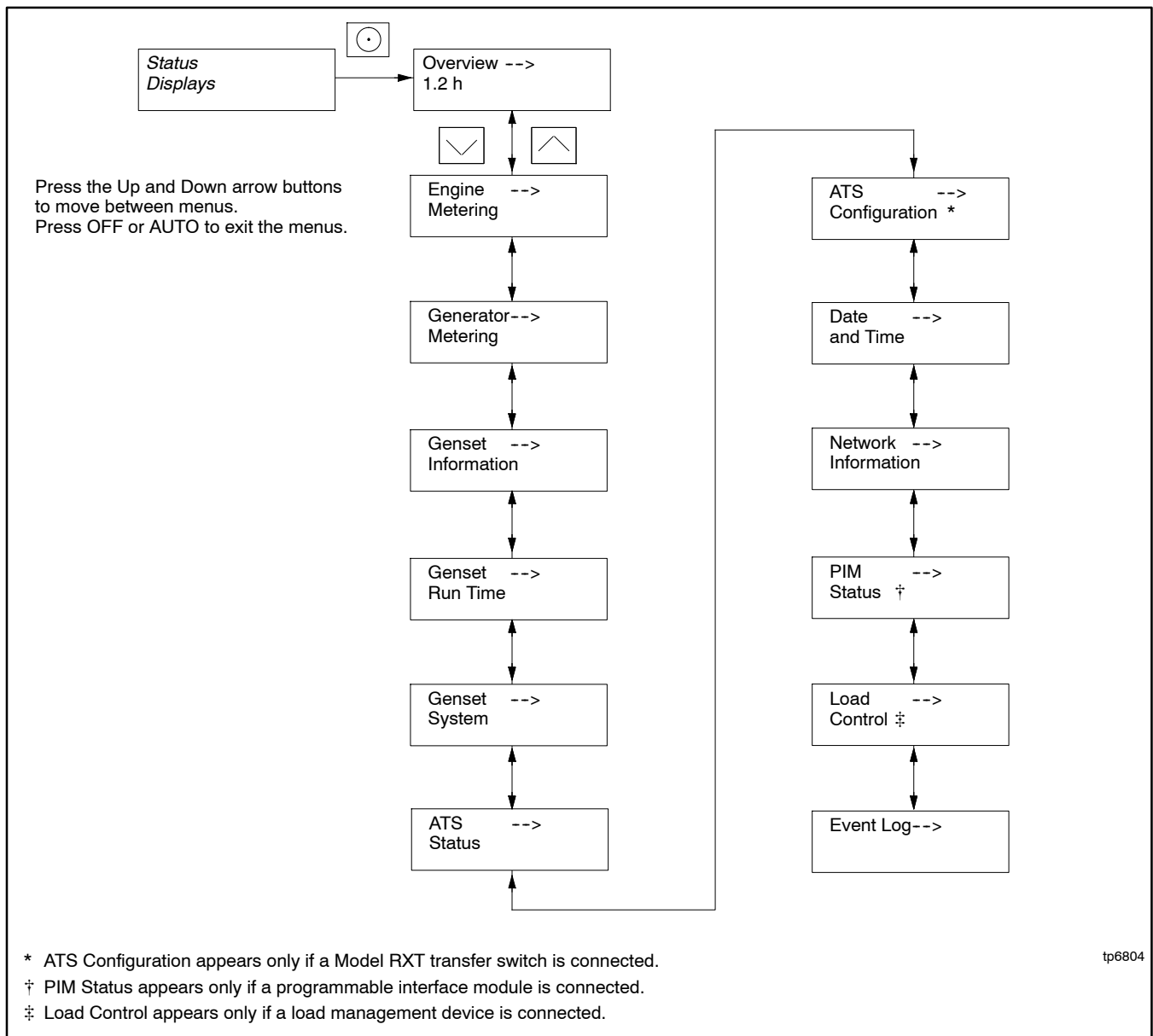

**Figure 3-7** RDC2 Main Menu

### 3.8 Overview Menu

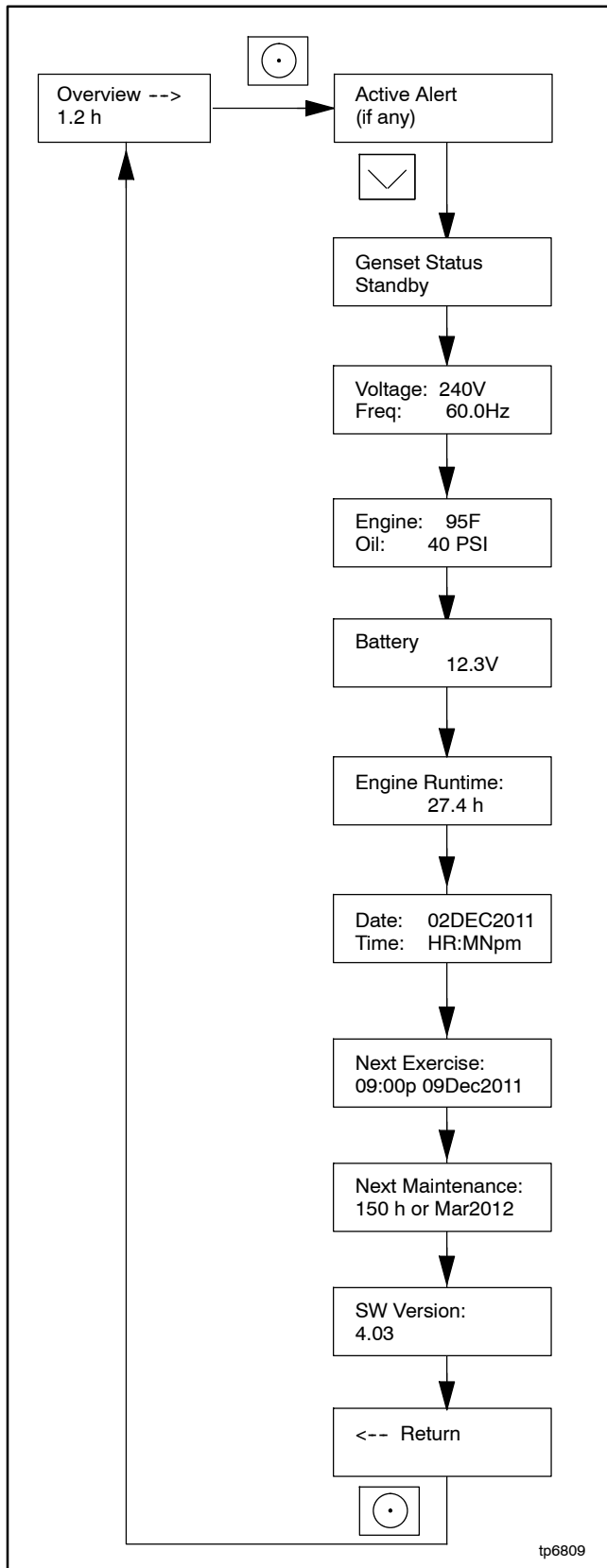

Figure 3-8 Overview Menu

### 3.9 Engine Metering Menu

The engine metering menu displays engine status information as shown in Figure 3-9. This menu displays status information only. No settings can be changed from this menu.

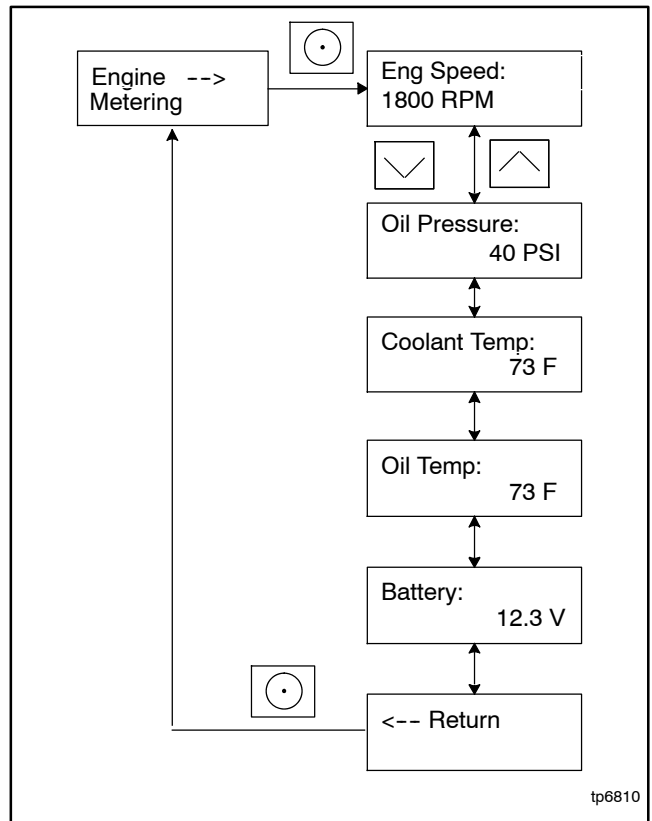

Figure 3-9 Engine Metering Menu

### 3.10 Generator Metering Menu

The generator metering menu displays the generator voltage and frequency. See Figure 3-10.

### Voltage Calibration

The voltage calibration mode can be entered from the Generator Metering menu. Contact a Kohler-authorized distributor/dealer for service.

The Reset Calibration menu allows you to set the voltage reading back to the original value after calibration, if necessary. See Figure 3-10.

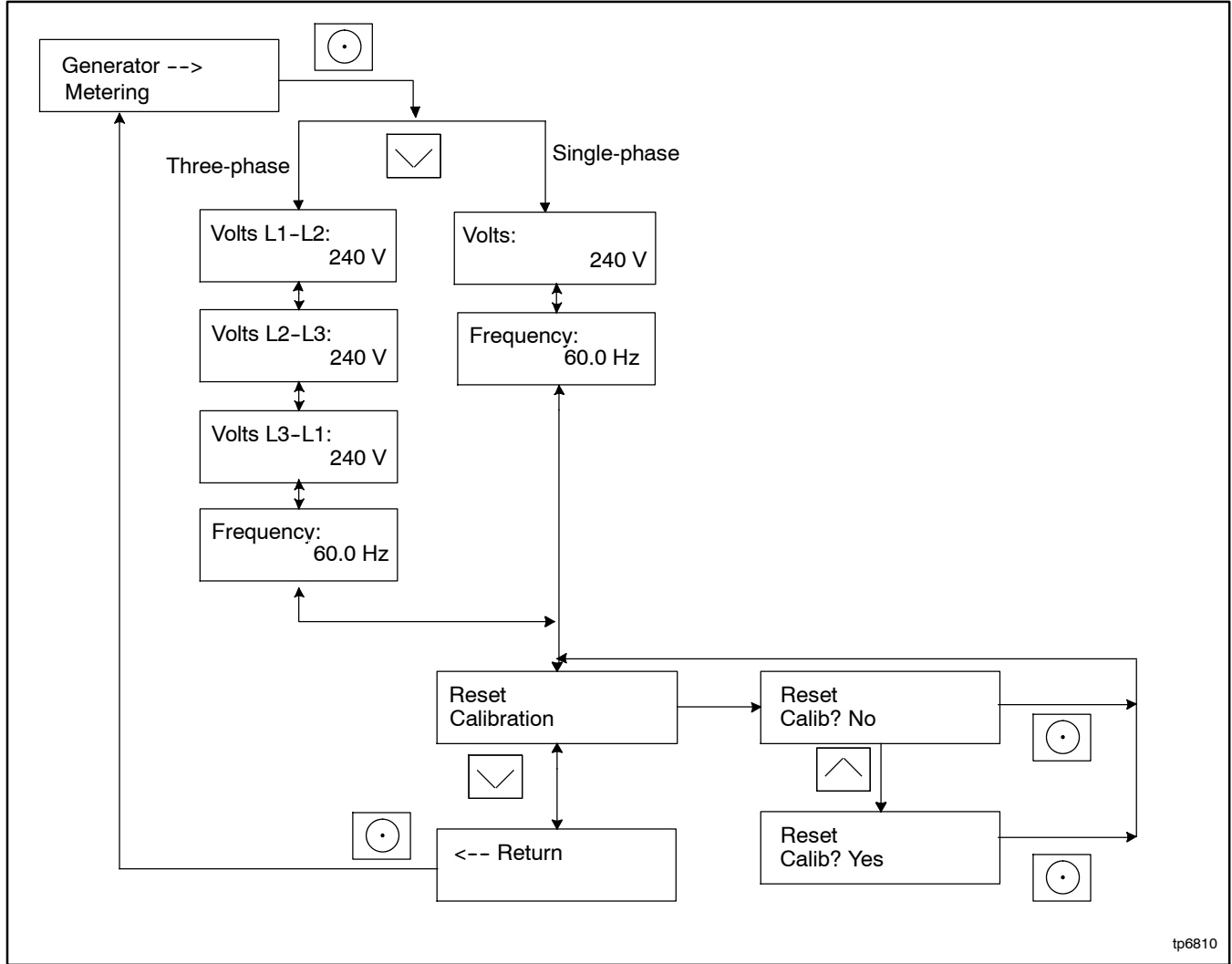

Figure 3-10 Generator Metering Menu

tp6810

### 3.11 Generator Set Information Menu

The generator set model number and serial numbers are displayed. No changes are allowed from this menu.

Model and serial numbers are factory set and should not require changes in the field, except in the event that the controller is being replaced. A personal computer running Kohler® SiteTech™ software is required to enter the generator set model number and serial numbers on a replacement controller. Contact an authorized Kohler distributor/dealer for service.

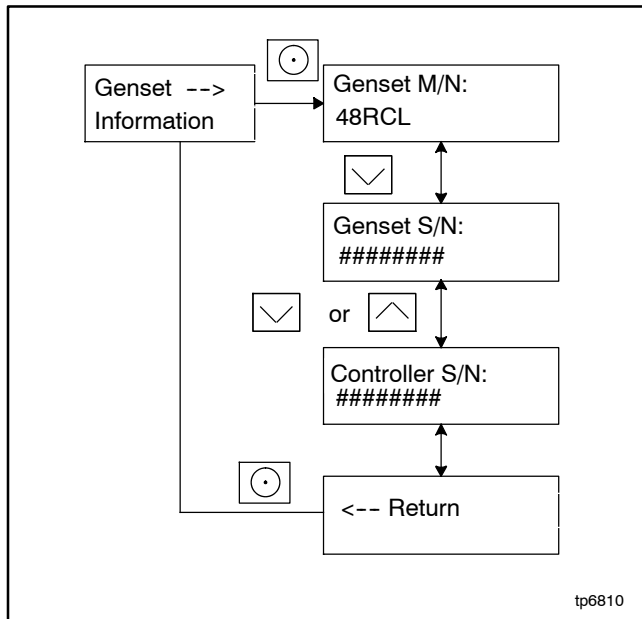

Figure 3-11 Generator Set Information Menu

### 3.12 Genset Run Time Menu

The data shown in Figure 3-12 are displayed. No changes are allowed from this menu.

The Next Maintenance menu shows the number of hours of generator set operation until maintenance is required. The estimated date for the next scheduled maintenance is also displayed. The maintenance reminder intervals are based on the engine manufacturer's recommendation for changing the oil. Refer to Section 4, Scheduled Maintenance, for maintenance instructions.

After changing the oil and performing other recommended maintenance, go to the Overview menu to reset the maintenance timer. See Section 4.3.4 for instructions to reset the maintenance timer.

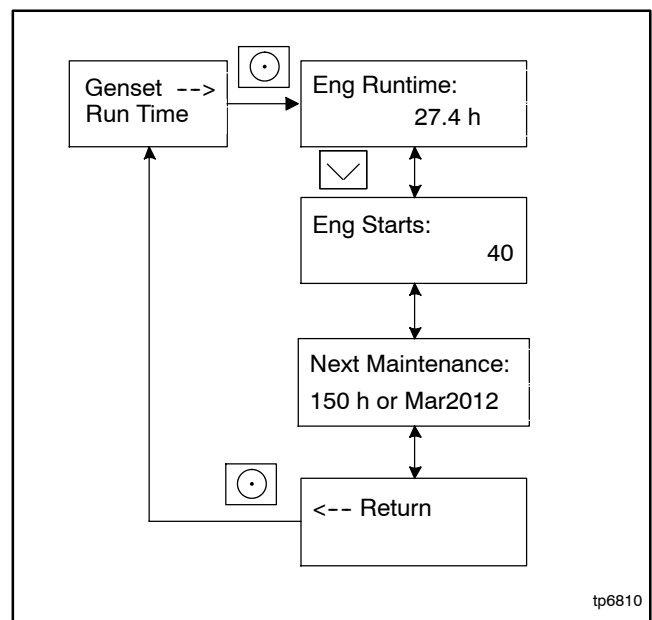

Figure 3-12 Generator Set Run Time Menu

### 3.13 Genset System Menu

The genset system menu displays the system information shown in Figure 3-13. Generator sets are factory set and should not require changes to the system settings in the field.

A Kohler authorized distributor or dealer can adjust these settings, if necessary. If the generator set is reconnected to a different voltage or the system settings require adjustment for some other reason, see Section 3.5 for instructions to enable editing and change the system settings.

**Note:** Use caution when navigating the controller menus. In some menus, pressing the Select button can enable editing of the controller settings. Changing the settings to incorrect values can adversely affect generator set operation or render the unit inoperable.

#### Voltage Regulator (VR) Voltage Adjust

The generator set voltage is factory set and typically does not require adjustment in the field. If voltage adjustment is required, contact a Kohler authorized distributor or dealer for service. Refer to the generator set Installation Manual for instructions to adjust the voltage.

#### Fuel Type

The fuel type, LP or natural gas, is shown. Do not change the fuel type in this menu unless the generator's fuel system has been converted by an authorized distributor or dealer.

#### Setting the Exerciser

Use the Genset System menus to set the generator set exerciser. Refer to Section 2.5 for instructions to set the exerciser and for more information about exercising the generator set.

After a scheduled exercise run, the Next Exercise time and date will be updated automatically based on the Exercise Frequency setting.

#### Adjusting the Display Contrast

To adjust the display contrast, use the down arrow button to step to the Contrast menu. Press the Select button, and then use the up and down arrow buttons to adjust the contrast. Press the Select button to save the contrast setting.

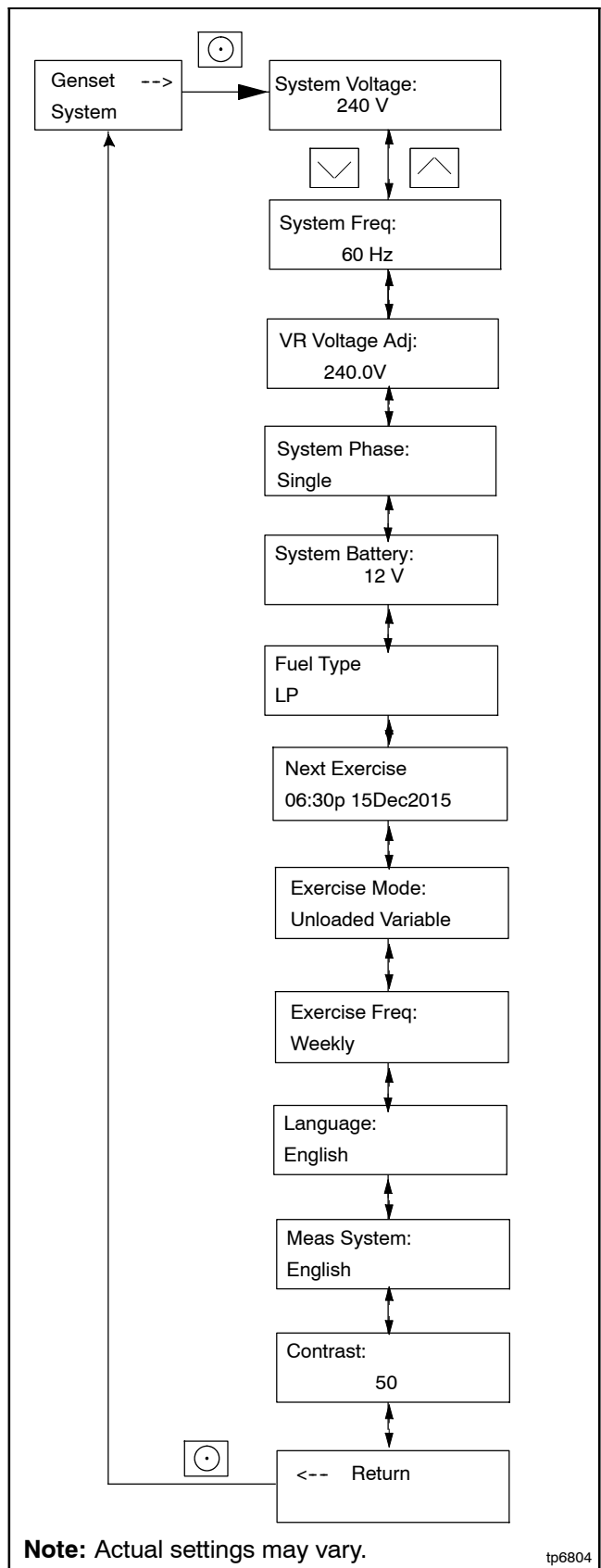

**Note:** Actual settings may vary.

tp6804

**Figure 3-13** Genset System Menu

### 3.14 ATS Status Menu

ATS menus appear if a Model RXT transfer switch is connected to the generator set. If no transfer switch is connected, or another model ATS is connected to the engine start connections, Remote ATS is displayed on the ATS Status screen.

The ATS Status menu displays Model RXT transfer switch and source information.

The voltage shown in these menus can be calibrated. Contact an authorized distributor or dealer for service if calibration is required.

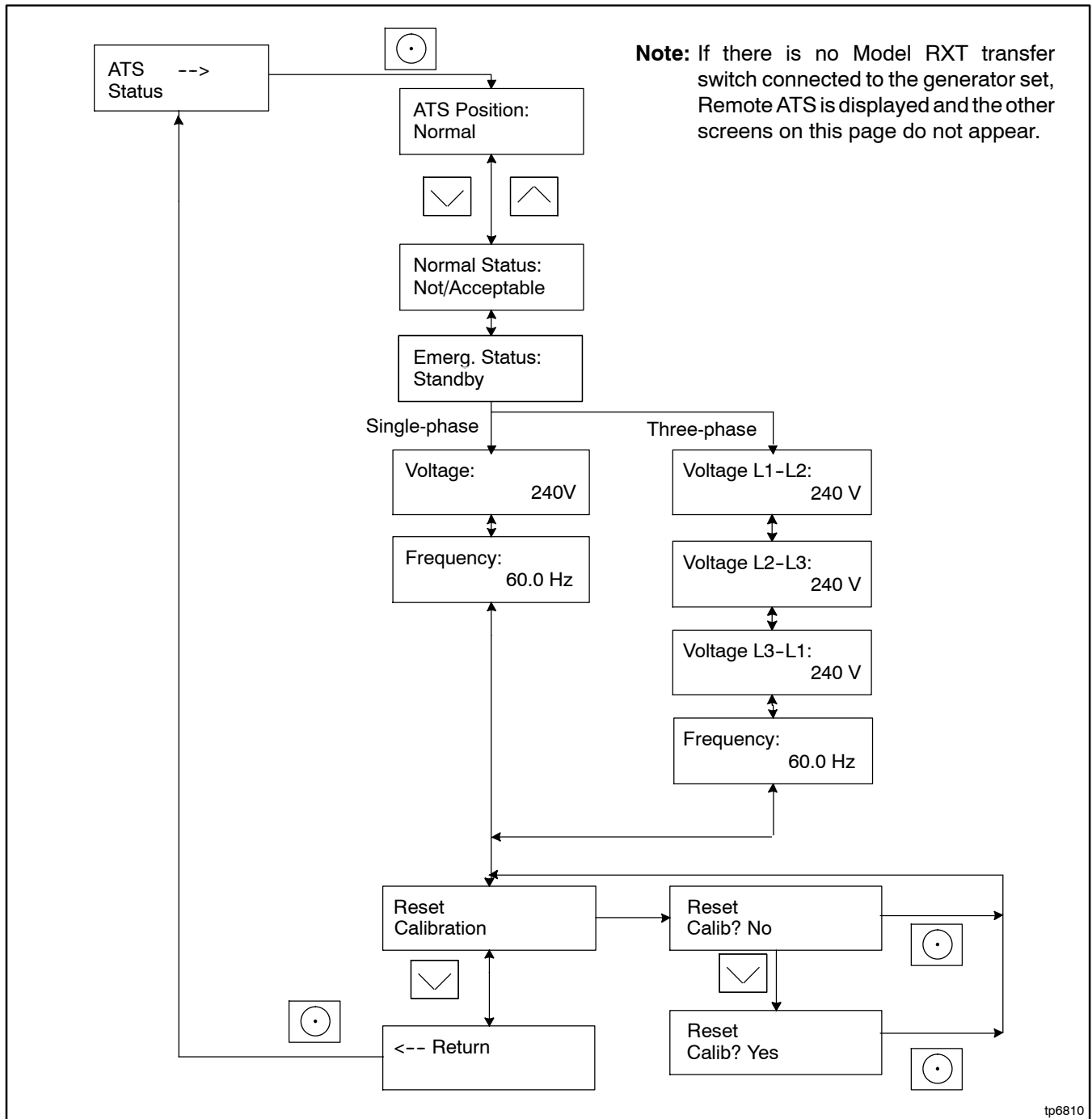

Figure 3-14 ATS Status Menu, with Calibration

### 3.15 ATS Configuration Menu

**Note:** The ATS Configuration menu appears only if a Model RXT transfer switch is connected.

Use the ATS Configuration submenu to check the Model RXT transfer switch system settings and time delays, and change the settings, if necessary.

#### Changing ATS Configuration Settings

To enable editing, press the select button. The value flashes to indicate that it can be changed. Press the up and down arrow buttons to change the value. Press the Select button to save the value shown.

Use the up and down arrow buttons to move to the next value to be changed. Repeat the adjustment process until all values are correct.

Press the down arrow until Return is displayed. Press the select button to return to the main menu.

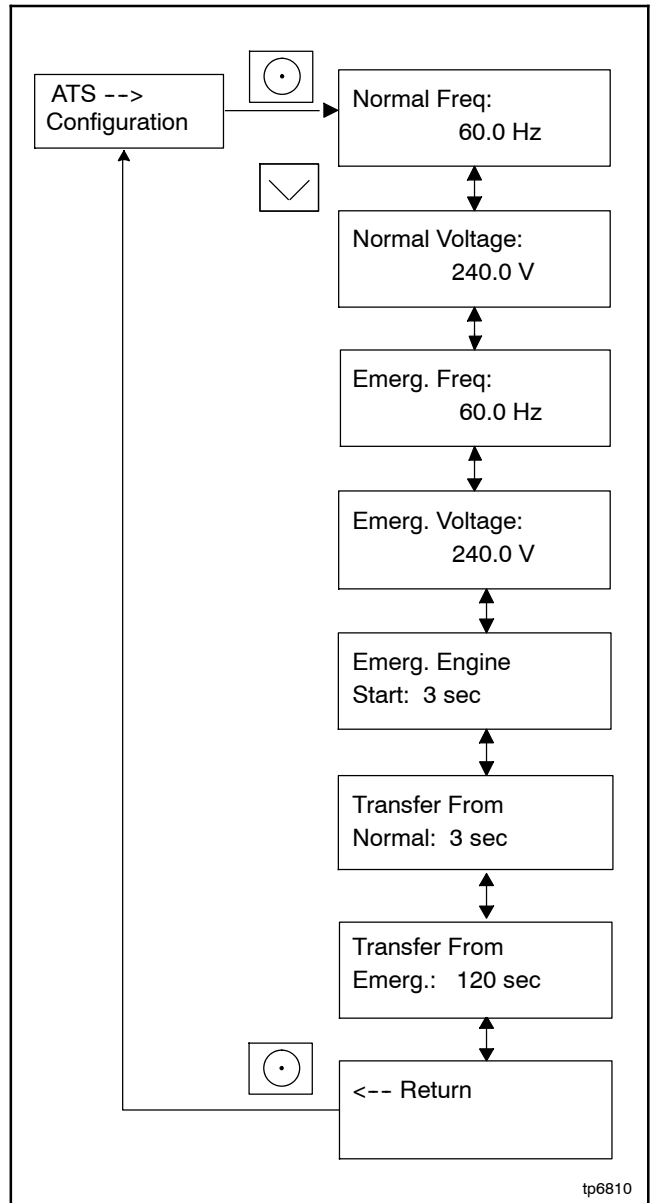
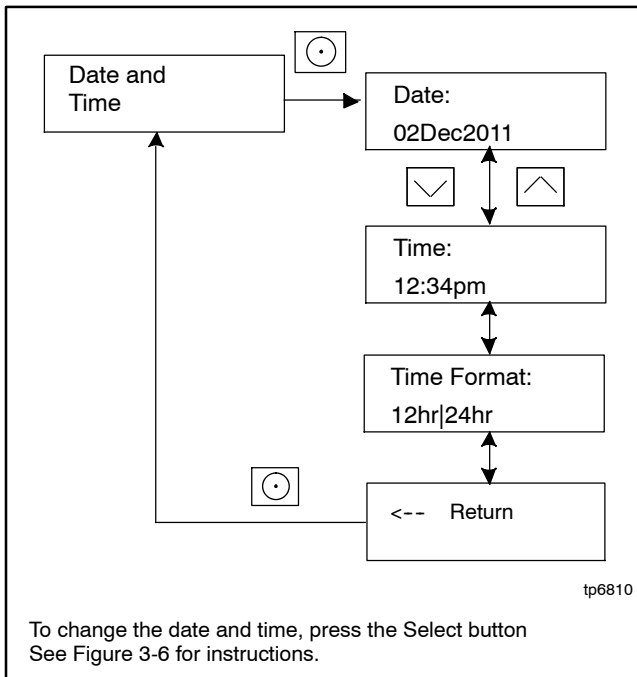

Figure 3-15 ATS Configuration Menu



### 3.16 Date and Time Menu

The date and time will typically be set at controller power-up. To change the date, time, or time format (12 hour or 24 hour), use the Date and Time menu. See Figure 3-16.



**Figure 3-16** Date and Time Menu

### 3.17 Networking Information Menus

Use the networking menus to view and adjust communication settings for systems with remote RBUS devices such as a PIM or load management device, and for systems that use the Kohler® OnCue® Plus Home Generator Management System.

The Networking Information menu leads to submenus for network and RBUS communication settings.

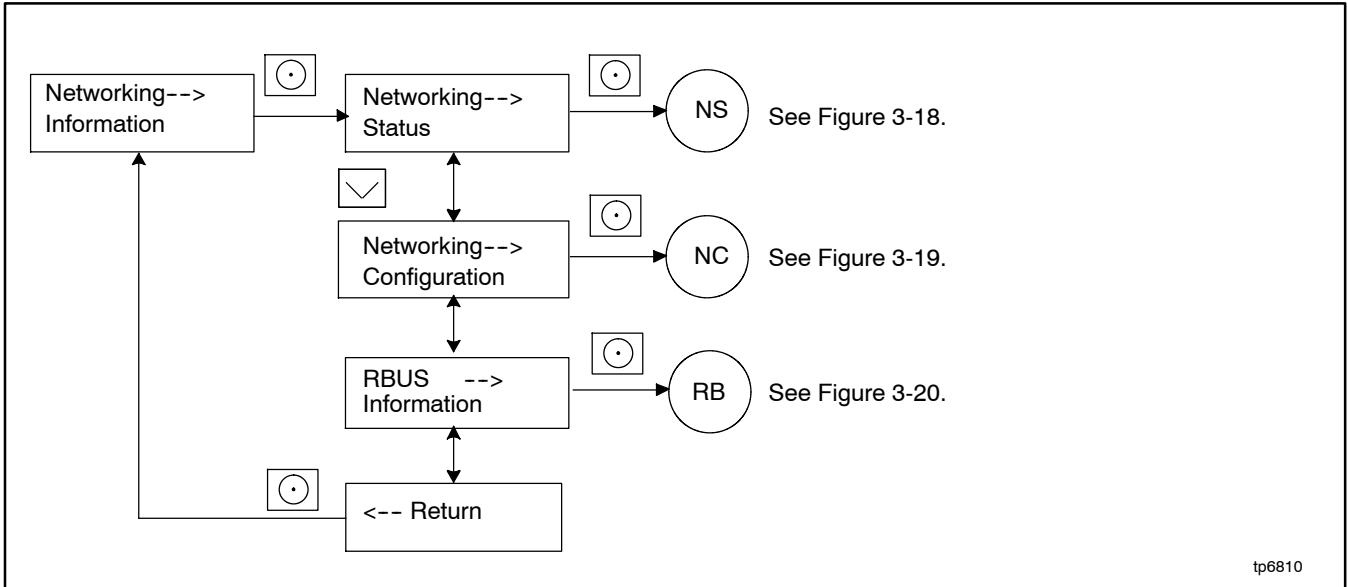

Figure 3-17 Networking Information Menu

tp6810

### 3.17.1 Networking Status Submenu

The Networking Status submenu contains settings for OnCue® Plus. See the OnCue® Plus Software Operation Manual for information about the appropriate network settings for OnCue® Plus.

If DHCP is enabled, IP parameters are not displayed. If DHCP is disabled (i.e., if a static IP address is used), the IP parameters are displayed.

To enable or disable DHCP and change the IP settings, go to the Networking Configuration menu. See Section 3.17.2.

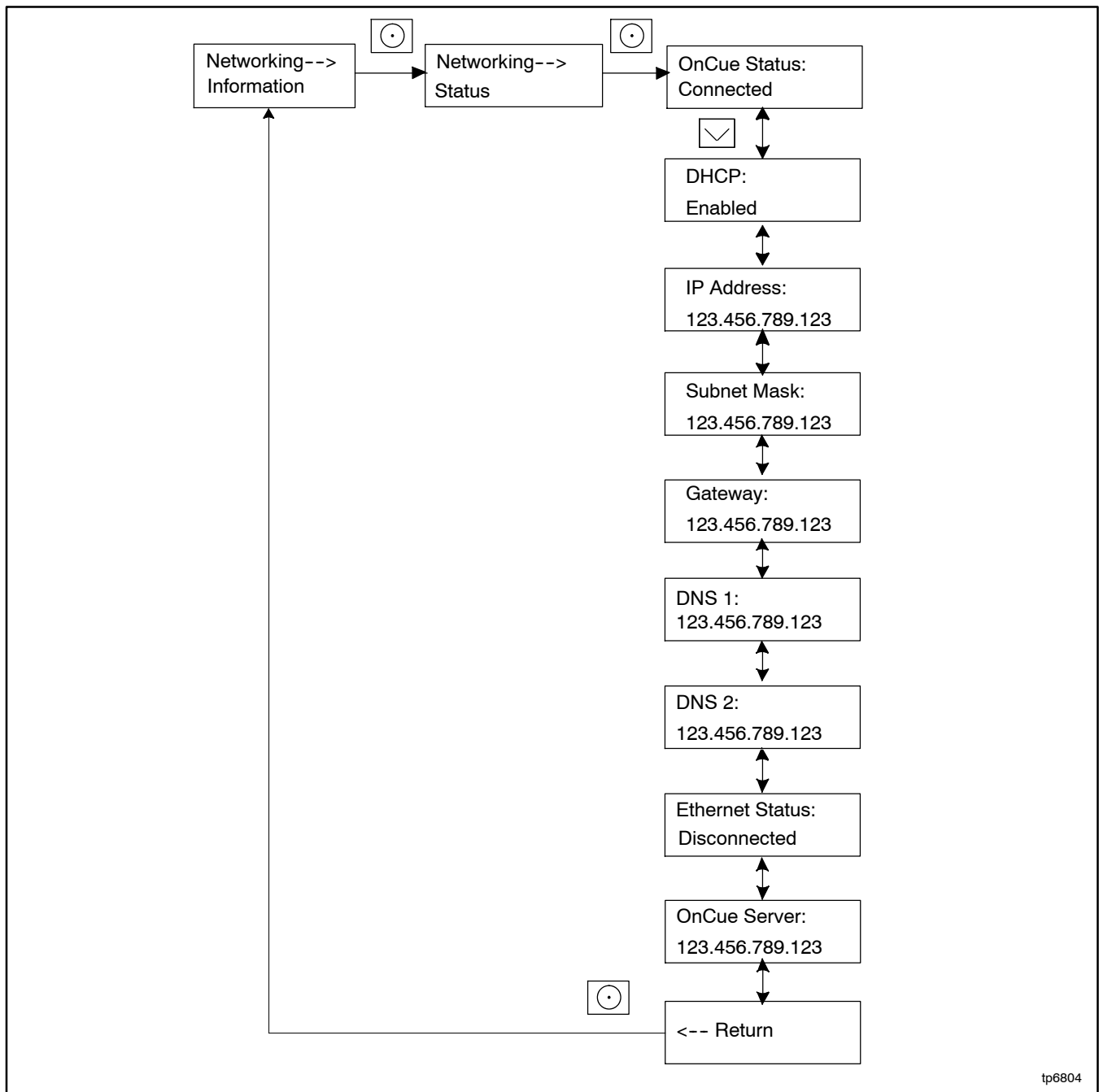

tp6804

Figure 3-18 Network Status Submenu

### 3.17.2 Networking Configuration Submenu (OnCue® Plus Password)

The networking Configuration menu includes settings used for communication with the Kohler® OnCue® Plus Generator Management System.

For most applications, DHCP is enabled and the IP settings cannot be changed from the controller keypad. If DHCP is enabled, IP parameters are not displayed.

If DHCP is disabled (i.e., if a static IP address is required), then the IP parameters can be modified. For applications that require static IP addresses, press and hold the select button to enable editing, disable DHCP, and then step to the next parameters and enter the information.

If an error occurs while setting a parameter, an error message is displayed and then the controller exits the edit mode. Previous settings are preserved.

**Note:** Use the OnCue password shown on the controller display for OnCue Plus applications.

For the initial OnCue Plus setup, you will be required to reset the OnCue password on the RDC2 controller, and then enter it into the OnCue Plus software. To reset the password, follow the instructions in Figure 3-19.

**Note:** The password is displayed for only 10 seconds. Be sure to write down the password and serial number.

A new password is generated each time the reset password procedure is performed. If the password is reset after the OnCue Plus system has been set up, the connection will be lost. Disconnect the battery power to the controller, wait a minute, then reconnect power.

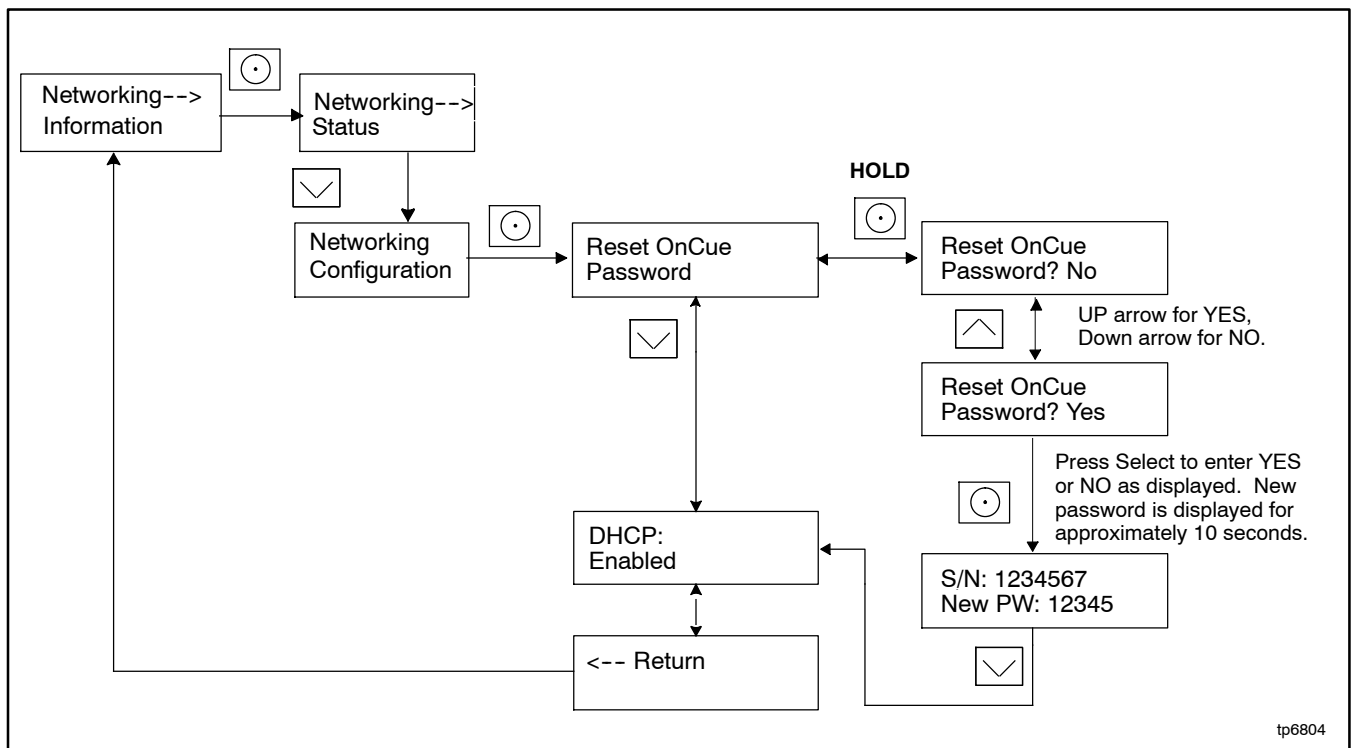

Figure 3-19 Network Configuration Submenu

### 3.17.3 RBUS Information Submenu

The RBUS Information menu contains settings for remote modules that communicate with the RDC2 controller using RBUS protocol. This includes the following optional modules:

- Model RXT transfer switch
- Programmable Interface Module (PIM)
- Load Shed Kit or RXT combined interface/load management board

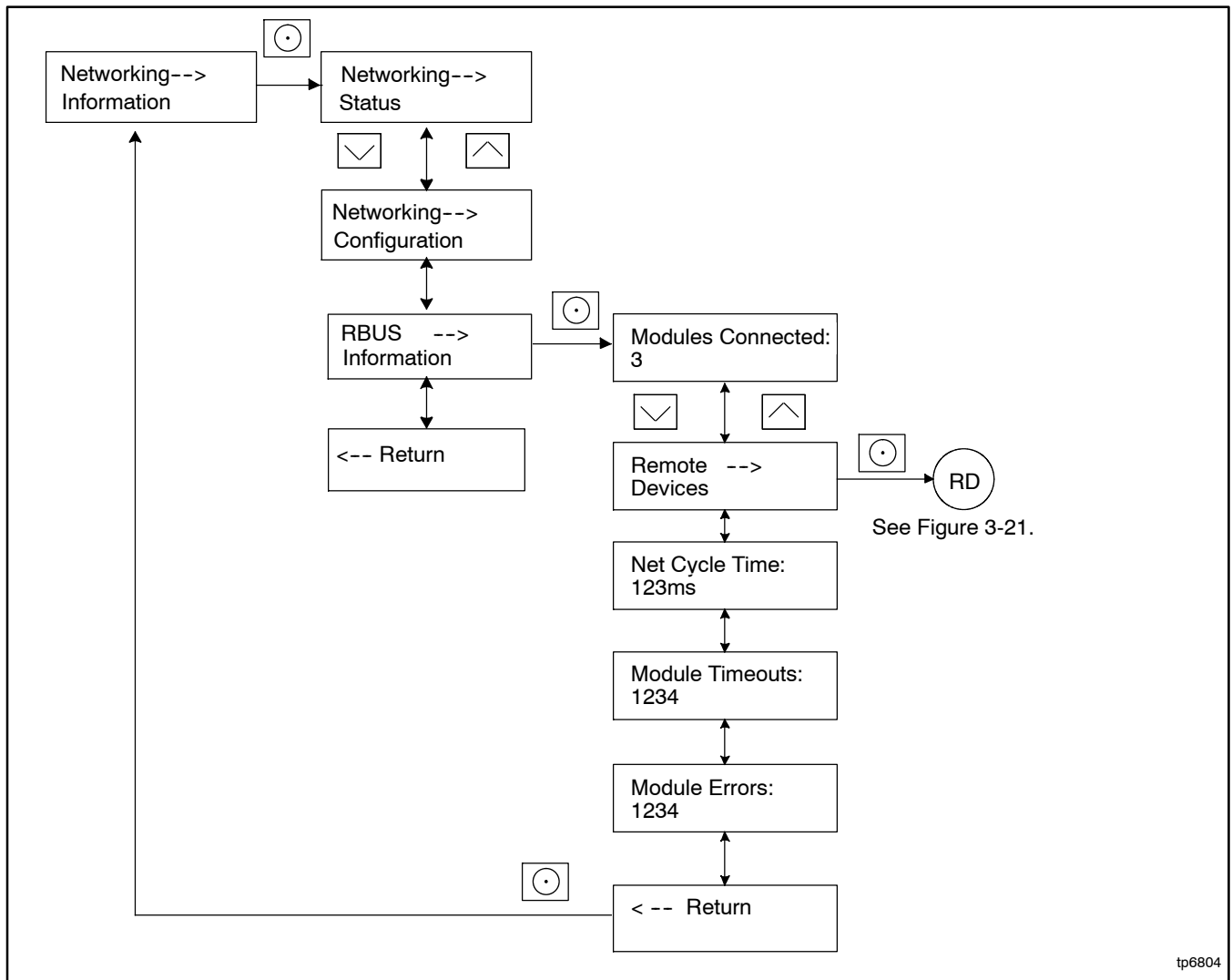

Figure 3-20 RBUS Information Submenu

### 3.17.4 Remote Devices Submenu

Check the status of remote devices communicating through RBUS. Device types can include:

- Model RXT ATS
- Programmable interface module (PIM)
- Load Shed Kit or RXT combined interface/load management board

The serial numbers for the PIM and load shed kit are printed on the circuit boards.

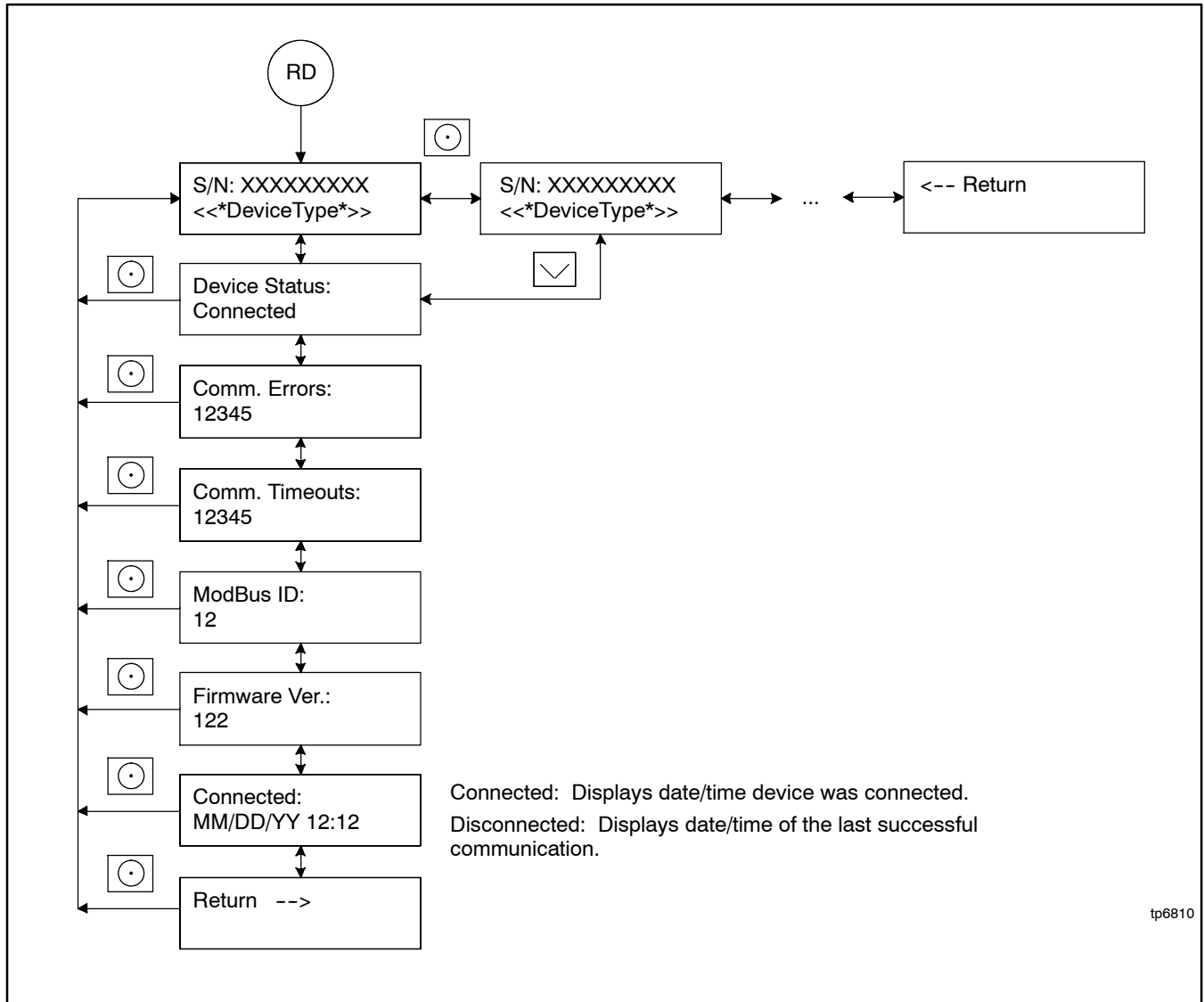

Figure 3-21 Remote Devices Submenu

### 3.18 Programmable Interface Module (PIM) Menus

The PIM status menu displays the status of inputs and outputs connected to the programmable interface module (PIM). This is a status display menu only. Input and output settings cannot be changed from the RDC2 controller's user interface.

A personal computer running Kohler® SiteTech™ software is required to change the input and output settings. Contact an authorized distributor or dealer for service.

The Kohler® OnCue® Plus Generator Management System can be used to turn outputs on and off. See the OnCue® Plus Software Operation Manual for instructions.

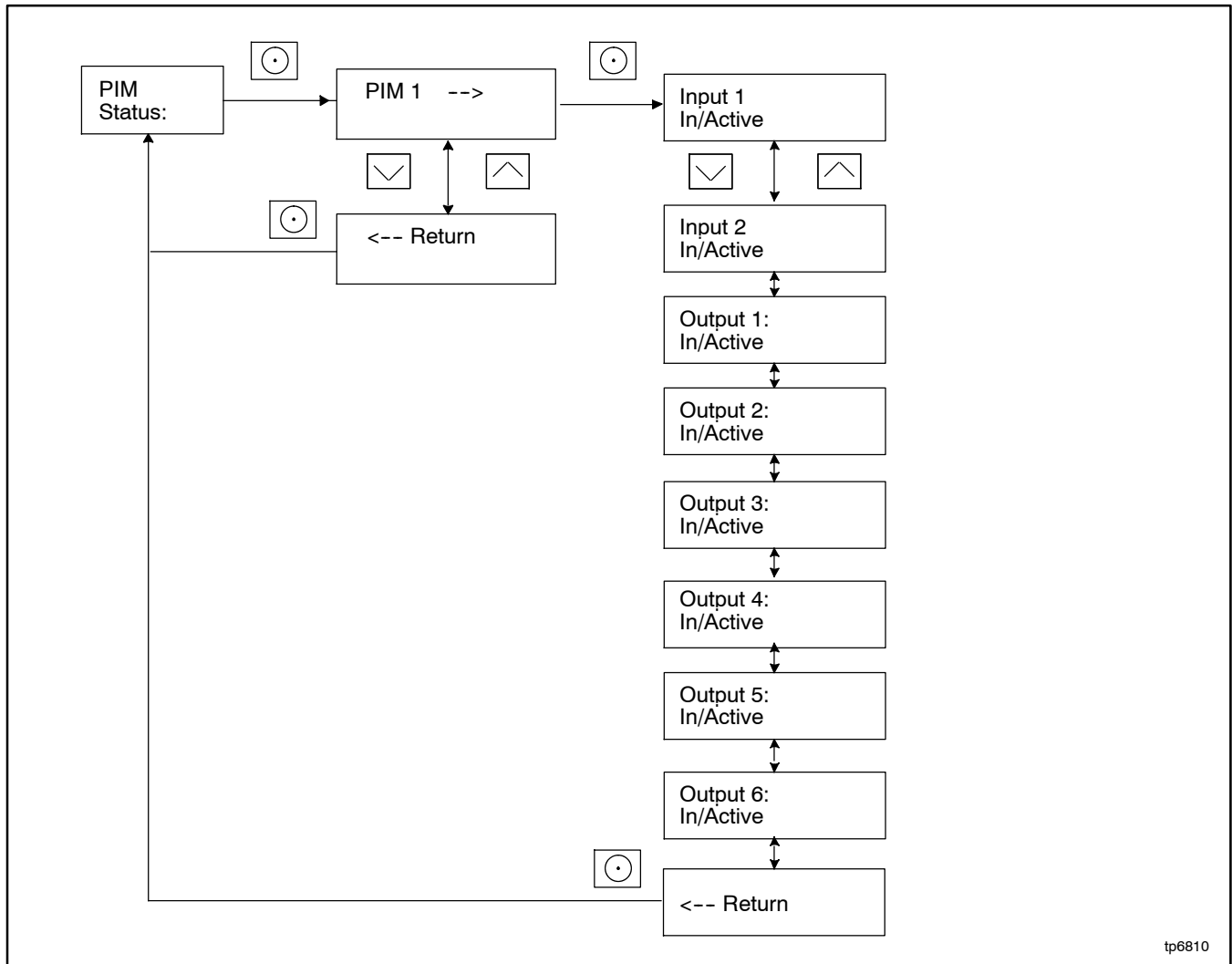

Figure 3-22 Programmable Interface Module (PIM) Status Menu

### 3.19 Load Control Menus

The Load Control menu displays the status of the load management inputs and outputs, and allows a test of the load management output relays. This menu appears only if a load management device is connected.

Generator current is displayed as a percent of the maximum generator capacity. The load management

device adds and sheds loads based on the generator current.

The test function cycles the relays in the order of their priority. For detailed information about load management operation, refer to TT-1609, provided with the load shed kit, or TP-6807, RXT Transfer Switch Operation and Installation Manual.

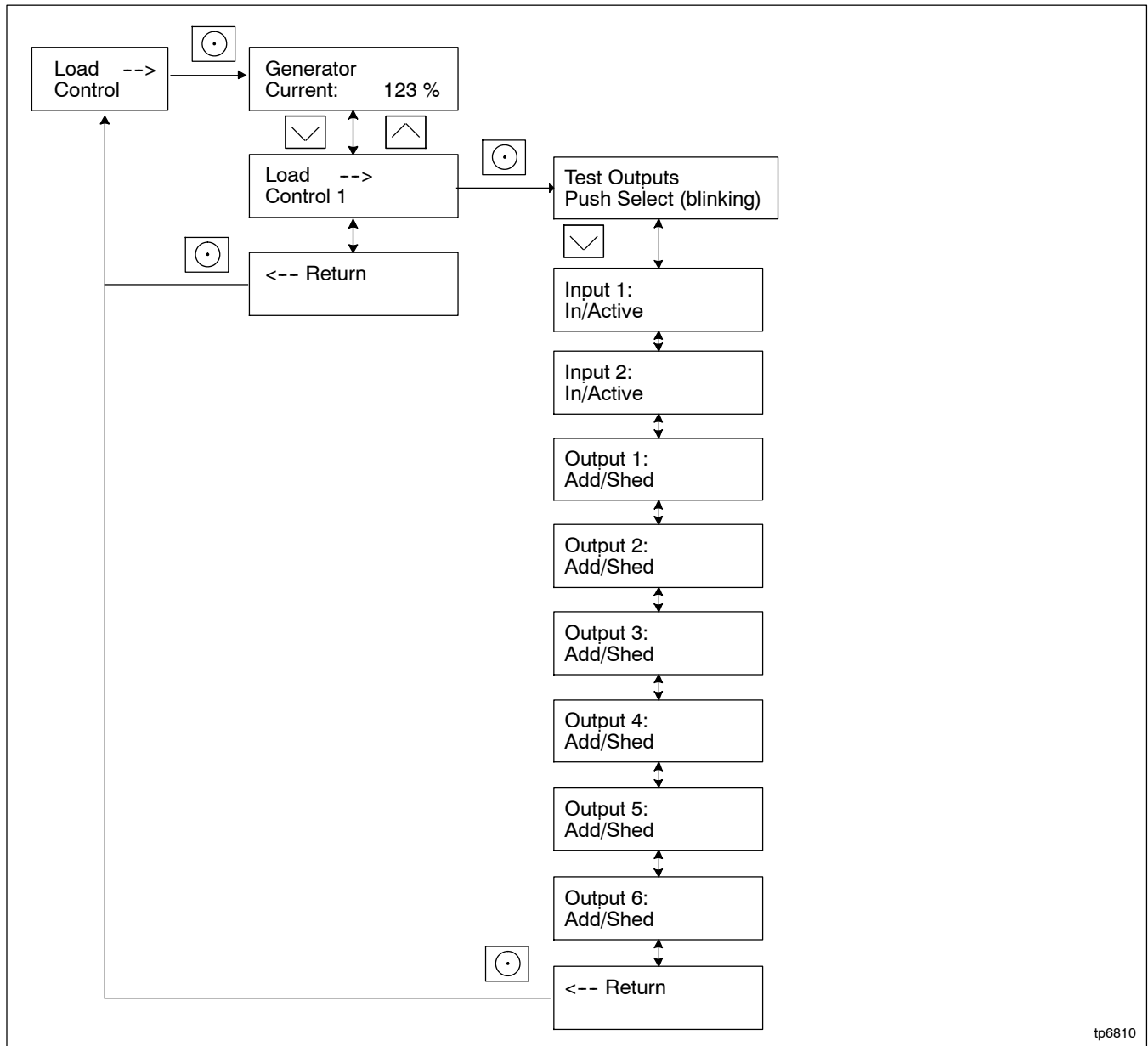

tp6810

**Figure 3-23** Load Control Status Menu



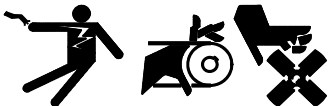

## Section 4 Scheduled Maintenance

### 4.1 General Maintenance



 <b>WARNING</b>

<b>Accidental starting. Can cause severe injury or death.</b>
Disconnect the battery cables before working on the generator set. Remove the negative (-) lead first when disconnecting the battery. Reconnect the negative (-) lead last when reconnecting the battery.

**Disabling the generator set. Accidental starting can cause severe injury or death.** Before working on the generator set or equipment connected to the set, disable the generator set as follows: (1) Move the generator set master switch to the OFF position. (2) Disconnect the power to the battery charger. (3) Remove the battery cables, negative (-) lead first. Reconnect the negative (-) lead last when reconnecting the battery. Follow these precautions to prevent starting of the generator set by an automatic transfer switch, remote start/stop switch, or engine start command from a remote computer.



 <b>WARNING</b>

<b>Hot engine and exhaust system. Can cause severe injury or death.</b>
Do not work on the generator set until it cools.

**Servicing the exhaust system. Hot parts can cause severe injury or death.** Do not touch hot engine parts. The engine and exhaust system components become extremely hot during operation.

**Servicing the alternator. Hot parts can cause severe injury or death.** Avoid touching the alternator field or exciter armature. When shorted, the alternator field and exciter armature become hot enough to cause severe burns.

 <b>WARNING</b>

<b>Hazardous voltage. Moving parts. Can cause severe injury or death.</b>
Operate the generator set only when all guards and electrical enclosures are in place.

**Servicing the generator set when it is operating. Exposed moving parts can cause severe injury or death.** Keep hands, feet, hair, clothing, and test leads away from the belts and pulleys when the generator set is running. Replace guards, screens, and covers before operating the generator set.

 <b>WARNING</b>

<b>Risk of fire. Can cause severe injury or death.</b>
Do not smoke or permit flames or sparks near fuels or the fuel system.

**Servicing the air cleaner. A sudden backfire can cause severe injury or death.** Do not operate the generator set with the air cleaner removed.

**Servicing the fuel system. A flash fire can cause severe injury or death.** Do not smoke or permit flames or sparks near the carburetor, fuel line, fuel filter, fuel pump, or other potential sources of spilled fuels or fuel vapors. Catch fuels in an approved container when removing the fuel line or carburetor.

**The fuel system. Explosive fuel vapors can cause severe injury or death.** Vaporized fuels are highly explosive. Use extreme care when handling and storing fuels. Store fuels in a well-ventilated area away from spark-producing equipment and out of the reach of children. Never add fuel to the tank while the engine is running because spilled fuel may ignite on contact with hot parts or from sparks. Do not smoke or permit flames or sparks to occur near sources of spilled fuel or fuel vapors. Keep the fuel lines and connections tight and in good condition. Do not replace flexible fuel lines with rigid lines. Use flexible sections to avoid fuel line breakage caused by vibration. Do not operate the generator set in the presence of fuel leaks, fuel accumulation, or sparks. Repair fuel systems before resuming generator set operation.

**Gas fuel leaks. Explosive fuel vapors can cause severe injury or death.** Fuel leakage can cause an explosion. Check the LPG vapor or natural gas fuel system for leakage by using a soap and water solution with the fuel system test pressurized to 6–8 ounces per square inch (10–14 inches water column). Do not use a soap solution containing either ammonia or chlorine because both prevent bubble formation. A successful test depends on the ability of the solution to bubble.

The engine and generator set may use both American Standard and metric hardware. Use the correct size tools to prevent rounding of the bolt heads and nuts.

See the Safety Precautions and Instructions at the beginning of this manual before attempting to service, repair, or operate the generator set. Have an authorized Kohler distributor/dealer perform generator set service.

**Engine Service.** Perform generator set engine service at the intervals specified by the engine operation manual.

**Generator Set Service.** Perform generator set service at the intervals specified by the generator set operation manual.

**Routine Maintenance.** Refer to the following generator set service schedule, the engine service schedule, and the runtime hours shown on the RDC2 controller to determine when to schedule routine maintenance. Service generator sets that are subject to extreme weather or dusty or dirty conditions more frequently.

**Maintenance and Service Parts.** Obtain maintenance and service parts from an authorized Kohler distributor/dealer.

## 4.2 Service Schedule

Perform maintenance on each item in the service schedule at the designated intervals for the life of the generator set.

Operation	Daily	Every 100 Hr.	Every 150 Hr.	Every 400 Hr.	Every 1000 Hr.	Every 1500 Hr.	Every 2000 Hr.	As Req'd
<b>GENERAL MAINTENANCE</b>								
Check for fluid leaks	X							
Check coolant level *	X							
Check engine oil level	X							
Check all bolts and nuts for tightness ‡	X						X	X
Change engine oil and filter †			X					
Check fuel system for leaks ‡							X	
Check belts and belt tension					X			
Inspect wiring for cuts, abrasions, or corrosion							X	
Inspect vacuum lines and fittings							X	
<b>AIR INTAKE SYSTEM</b>								
Inspect and clean air cleaner element †			X					X
Replace air cleaner element †				X				X
Check air induction for leaks					X			
Check intake manifold for vacuum leaks					X			
<b>COOLING SYSTEM</b>								
Inspect and clean radiator exterior ‡		X						X
Replace engine coolant §					X			
Inspect coolant hoses					X			
<b>ELECTRICAL SYSTEM</b>								
Check battery charge and fluid level ‡		X						X
Inspect electrical system							X	
Clean battery cables ‡								X
<b>EXHAUST SYSTEM</b>								
Inspect exhaust manifold for leaks							X	
Inspect exhaust piping for leaks							X	
Check HEGO (oxygen) sensor connections and wires							X	
<b>FUEL SYSTEM</b>								
Check fuel shutoff valve for leaks and function							X	
Check fuel regulator pressure							X	
Test fuel lines for leaks							X	
Inspect/drain vaporizer for oil buildup							X	
<b>IGNITION SYSTEM</b>								
Check spark plug wires for cuts, abrasions, or hardening					X			
Clean secondary ignition coil wires					X			
Replace distributor cap and rotor							X	
Replace spark plugs				X		X		
Replace spark plug wires							X	
* Check engine coolant condition and protection, hoses, and clamps annually (prior to cold weather). † More frequent intervals may be required in dusty or dirty operating conditions. ‡ Seasonal or as required. § Long-life coolant is recommended. When long-life coolant is used, the change interval is 5000 hours or 5 years. Do not mix coolant types.								

## 4.3 Lubrication System

### 4.3.1 Oil Specifications

Use oil that displays the American Petroleum Institute (API) Starburst certification mark FOR GASOLINE ENGINES on the container. Do not use straight-weight oils recommended for industrial or stationary engines. CC or CD classification oils, even when labeled Heavy Duty or For Natural Gas Engines are not acceptable.

Multi-viscosity oils are recommended. Figure 4-1 shows the recommended Society of Automotive Engineers (SAE) viscosity designation for a given operating temperature.

Ambient Temperature	Engine Oil Type
-18°C (0°F) and above	SAE 10W-30
Below -18°C (0°F)	SAE 5W-30

Figure 4-1 Engine Oil Selection

### 4.3.2 Oil Check

Check the oil level in the crankcase every 24 hours of operation or before the engine is started each day. Do not check the oil level while operating the unit. Stop the generator set and keep the generator set level to get an accurate reading. To check the oil level, remove the dipstick and wipe the end clean. Reinsert the dipstick and wait at least 30 seconds. Remove the dipstick and check the level. Maintain the oil level between the Full and Add marks on the dipstick, as shown in Figure 4-2. See Section 1, Service Views for the dipstick location.

**Note:** Do not operate the set if the oil level is below the Add mark or above the Full mark on the dipstick.

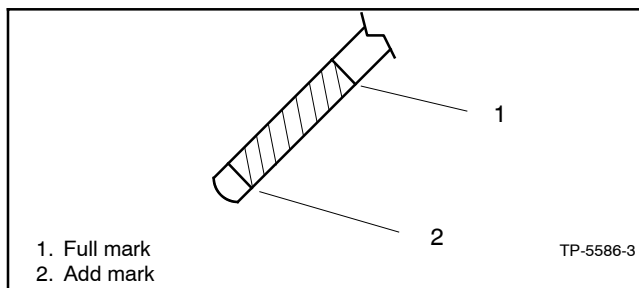

Figure 4-2 Oil Level Check

### 4.3.3 Oil Additions

Adding some oil between oil changes is normal. The amount varies with generator set usage. Open the oil fill cap and pour in a small amount of oil using a funnel or other suitable pouring device. See Section 1, Service Views, for the oil check and oil fill locations.

### 4.3.4 Oil and Filter Change

#### ⚠ WARNING

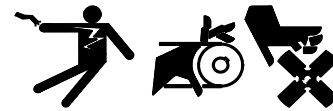

**Accidental starting.  
Can cause severe injury or death.**

Disconnect the battery cables before working on the generator set. Remove the negative (-) lead first when disconnecting the battery. Reconnect the negative (-) lead last when reconnecting the battery.

**Disabling the generator set. Accidental starting can cause severe injury or death.** Before working on the generator set or equipment connected to the set, disable the generator set as follows: (1) Press the generator set off/reset button to shut down the generator set. (2) Disconnect the power to the battery charger, if equipped. (3) Remove the battery cables, negative (-) lead first. Reconnect the negative (-) lead last when reconnecting the battery. Follow these precautions to prevent the starting of the generator set by the remote start/stop switch.

Change the oil according to the service schedule or before generator set storage. Change the oil more frequently if the generator set operates under dirty, dusty conditions. Change the oil while the engine is still warm. See Section 1, Service Views, for oil fill, oil check, and oil filter locations.

Dispose of all waste materials (engine oil, fuel, filter, etc.) in an environmentally safe manner.

**Note:** Reset the maintenance timer on the RDC2 controller after changing the oil.

#### Oil Change Procedure

Whenever possible, drain the oil while it is still warm.

##### 1. Drain the oil.

- Press the OFF button on the RDC2 generator set controller.
- Disconnect the power for the battery charger.

- c. Disconnect the generator set engine starting battery, negative (-) lead first.
- d. Remove the housing side panel.
- e. Remove the plug from the oil drain fitting and install a drain hose.
- f. Open the oil drain valve on the engine.
- g. Allow time for the engine oil to drain completely.
- h. Close the oil drain valve.
- i. Replace the oil drain plug.

**2. Replace the oil filter.**

- a. Remove the oil filter by rotating it counterclockwise with an oil filter wrench.
- b. Clean the contact surface of the oil filter adapter.
- c. Apply a light coat of clean oil to the rubber seal of the new oil filter.
- d. Install the new oil filter following the instructions provided with the filter.

**3. Fill with oil.** See Figure 4-1 for oil selection and Figure 4-3 for oil capacity.

Model	Oil Capacity, L (qt.)
38RCL, 48RCL, 48RCLA, and 60RCL	4.7 (5.0)

**Figure 4-3** Oil Capacity

**4. Check for leaks.**

- a. Press the OFF button on the RDC2 generator set controller.
- b. Reconnect the generator set engine starting battery, negative (-) lead last.
- c. Reconnect the power for the battery charger.
- d. Start the generator set and check for leaks around the oil filter.
- e. Stop the generator set and tighten the oil filter to stop any leaks.
- f. Reinstall the housing side panel.

**5. Stop the generator set.** Check the oil level. Add oil, as necessary, to bring the level up to the Full mark.

**Note:** Too high an oil level causes high oil consumption and engine carbonizing. Too low a level damages the engine.

**6. Reset the maintenance timer on the RDC2.**

- a. In the Overview menu, step down to the Next Maintenance screen.
- b. Press the Select button.
- c. Press the Up arrow button so that Reset Maint Timer? Yes is displayed.
- d. Press the Select button. The next maintenance interval and date will be displayed.

## 4.4 Air Cleaner

### **⚠ WARNING**

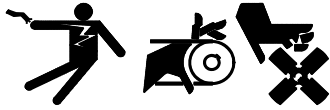

#### **Accidental starting. Can cause severe injury or death.**

Disconnect the battery cables before working on the generator set. Remove the negative (-) lead first when disconnecting the battery. Reconnect the negative (-) lead last when reconnecting the battery.

**Disabling the generator set. Accidental starting can cause severe injury or death.** Before working on the generator set or equipment connected to the set, disable the generator set as follows: (1) Press the generator set off/reset button to shut down the generator set. (2) Disconnect the power to the battery charger, if equipped. (3) Remove the battery cables, negative (-) lead first. Reconnect the negative (-) lead last when reconnecting the battery. Follow these precautions to prevent the starting of the generator set by the remote start/stop switch.

### **⚠ WARNING**



#### **Risk of fire. Can cause severe injury or death.**

Do not smoke or permit flames or sparks near fuels or the fuel system.

**Servicing the air cleaner. A sudden backfire can cause severe injury or death.** Do not operate the generator set with the air cleaner removed.

At the interval specified in the service schedule, inspect and clean or replace the air cleaner element. Clean the element more frequently in dirty, dusty conditions. Check the element for accumulated oil or dirt that could cause poor performance. Replace a damaged air cleaner element. Follow the procedure described below.

### **Air Cleaner Service Procedure**

A dry-type air cleaner silences and filters the intake air. The air intake silencer assembly connects to the intake manifold via a rubber hose. Refer to Figure 4-4 during this procedure.

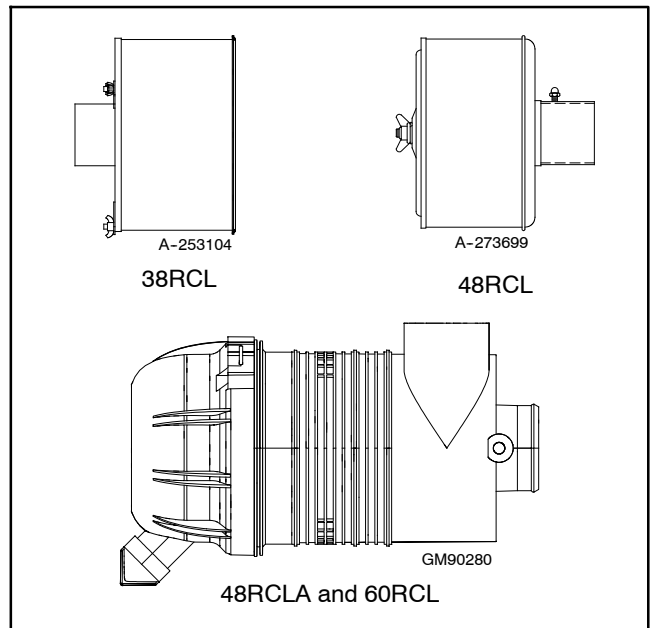

**Figure 4-4** Air Cleaners

1. Remove the cover from the air cleaner housing.
2. Remove the air cleaner element.
3. Examine the element and housing for damage. Replace the element and housing if damaged.
4. Tap the element lightly against a flat surface to dislodge loose surface dirt. Do not clean the element in any liquid or use compressed air as these will damage the filter element. Replace the element and precleaner at the intervals shown in the service schedule.
5. Wipe the cover and housing with a clean rag to remove dirt. Make sure the sealing surfaces fit correctly.
6. Replace the air cleaner cover.

## 4.5 Exhaust System

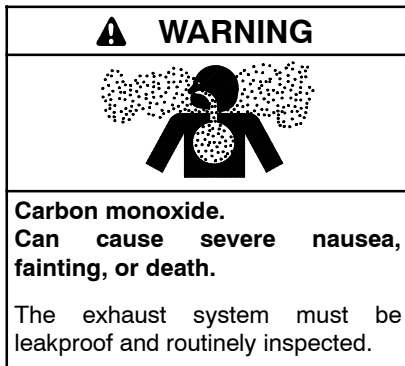

**Generator set operation. Carbon monoxide can cause severe nausea, fainting, or death.** Carbon monoxide is an odorless, colorless, tasteless, nonirritating gas that can cause death if inhaled for even a short time. Avoid breathing exhaust fumes when working on or near the generator set. Never operate the generator set inside a building. Never operate the generator set where exhaust gas could seep inside or be drawn into a potentially occupied building through windows, air intake vents, or other openings.

**Carbon monoxide symptoms. Carbon monoxide can cause severe nausea, fainting, or death.** Carbon monoxide is a poisonous gas present in exhaust gases. Carbon monoxide is an odorless, colorless, tasteless, nonirritating gas that can cause death if inhaled for even a short time. Carbon monoxide poisoning symptoms include but are not limited to the following:

- Light-headedness, dizziness
- Physical fatigue, weakness in joints and muscles
- Sleepiness, mental fatigue, inability to concentrate or speak clearly, blurred vision
- Stomachache, vomiting, nausea

If experiencing any of these symptoms and carbon monoxide poisoning is possible, seek fresh air immediately and remain active. Do not sit, lie down, or fall asleep. Alert others to the possibility of carbon monoxide poisoning. Seek medical attention if the condition of affected persons does not improve within minutes of breathing fresh air.

**Carbon monoxide detectors. Carbon monoxide can cause severe nausea, fainting, or death.** Install carbon monoxide detectors on each level of the building. Locate the detectors to adequately warn the building's occupants of the presence of carbon monoxide. Keep the detectors operational at all times. Periodically test and replace the carbon monoxide detectors according to the manufacturer's instructions.

---

### **CAUTION**



**Hazardous noise.**  
**Can cause hearing loss.**

Never operate the generator set without a muffler or with a faulty exhaust system.

---

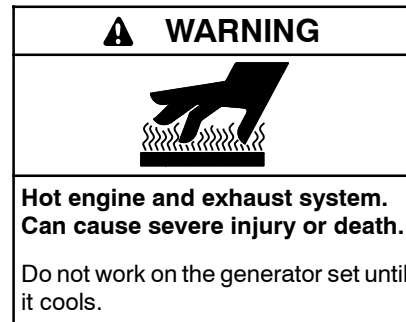

**Servicing the exhaust system. Hot parts can cause severe injury or death.** Do not touch hot engine parts. The engine and exhaust system components become extremely hot during operation.

At the interval specified in the service schedule, inspect the exhaust system components (exhaust manifold, exhaust outlet, exhaust line, exhaust clamps, and muffler) for cracks, leaks, and corrosion.

#### **Exhaust System Inspection Points**

- Check for corroded or broken metal parts and replace them as needed.
- Check that the exhaust outlet is unobstructed.
- Check the exhaust gas color. If the exhaust is blue or black, contact your local authorized Kohler distributor/dealer.
- Visually inspect for exhaust leaks (*blowby*). Check for carbon or soot residue on exhaust components. Carbon and soot residue indicates an exhaust leak. Seal leaks as needed.
- Check that all covers and doors are undamaged, in place, and locked.
- Check for the installation and operation of carbon monoxide (CO) detectors on each level of any building near the generator set.

## 4.6 Cooling System

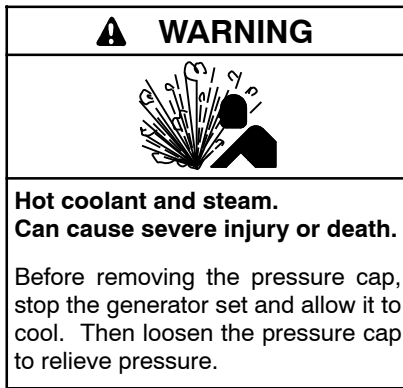

Allow the engine to cool. Release pressure from the cooling system before removing the pressure cap. To release pressure, cover the pressure cap with a thick cloth and then slowly turn the cap counterclockwise to the first stop. Remove the cap after pressure has been completely released and the engine has cooled. Check the coolant level at the tank if the generator set has a coolant recovery tank.

**Note: Block heater damage.** The block heater will fail if the energized heater element is not immersed in coolant. Fill the cooling system before turning on the block heater. Run the engine until it is warm and refill the radiator to purge the air from the system before energizing the block heater.

### 4.6.1 Checking and Filling Coolant

Maintain the coolant level in the coolant overflow bottle between the High and Low markings. See Section 1, Service Views, for the coolant overflow bottle location.

**Note:** Periodically check the coolant level by removing the radiator's pressure cap. Do not rely solely on the level in the coolant overflow bottle.

Ethylene glycol-based long-life coolant is recommended. Use a coolant mixture of 50% long-life coolant and 50% clean, softened water to inhibit rust/corrosion and prevent freezing. Add fresh coolant until the level is just below the overflow tube opening.

A coolant solution of 50% ethylene glycol-based coolant provides freezing protection to  $-37^{\circ}\text{C}$  ( $-34^{\circ}\text{F}$ ) and overheating protection to  $129^{\circ}\text{C}$  ( $265^{\circ}\text{F}$ ). A coolant solution with less than 50% ethylene glycol may not provide adequate freezing and overheating protection. A coolant solution with more than 50% ethylene glycol can cause engine or component damage. Do not mix long-life coolant and conventional coolants. Do not use alcohol or methanol antifreeze or mix them with the specified coolant.

### 4.6.2 Cooling System Inspection

To prevent generator shutdown or damage because of overheating:

- Keep the cooling air inlets clean and unobstructed
- Inspect the radiator's exterior for obstructions and remove dirt and foreign material with a soft brush or cloth to avoid damaging the radiator fins.
- Check the hoses and connections for leaks and replace any cracked, frayed, or spongy hoses.
- Check the condition and tension of the radiator water pump belt(s).
- Check the rubber seal of the radiator's pressure cap and replace a cracked or deteriorated cap. Remove dirt and other debris from the pressure cap and filler neck. The pressure cap raises the boiling point of the coolant, enabling higher operating temperatures. If the cap leaks, replace it with the same rating type of cap. Find the pressure cap rating in Figure 4-5.

Item	Rating
Pressure cap	97 kPa (14 psi)

**Figure 4-5** Pressure Cap Rating

### 4.6.3 Draining Cooling System

The radiator contains a coolant drain valve to drain the cooling system. When draining the coolant, remove the radiator's pressure cap, which will allow the entire system to drain and will prevent air pockets from forming and restricting coolant passage to the block.

1. De-energize the block heater, if equipped.
2. Remove the pressure cap to allow the entire system to drain and prevent air pockets from restricting coolant flow through the engine block.
3. Open the coolant drain valve and allow the system to drain.
4. If the inside of the radiator has mineral deposits or the used coolant contains dirt or grease, go to Section 4.6.4, Flushing and Cleaning. If the cooling system does not have mineral deposits, refill the cooling system as instructed in Section 4.6.5, Filling Cooling System.



## 4.6.4 Flushing and Cleaning

For optimum protection, drain, flush, and refill the cooling system at the interval listed in the service schedule.

### Flushing and Cleaning Procedure

1. Flush the system with clean water.
2. Drain, clean, and flush the coolant overflow bottle.
3. Refill the cooling system as instructed in Section 4.6.5.

## 4.6.5 Filling Cooling System

Model	Coolant Capacity, L (gal.)	
	Generator Set	With Block Heater
38RCL	15 (4.0)	15.6 (4.2)
48RCL	17 (4.5)	17.6 (4.7)
48RCLA	20.8 (5.5)	21.4 (5.7)
60RCL	20.8 (5.5)	21.4 (5.7)

**Figure 4-6** Coolant Capacity

**Note:** Do not add coolant to a hot engine. Adding coolant to a hot engine can cause the cylinder block or cylinder head to crack. Wait until engine has cooled.

1. Close the radiator's coolant drain valve and tighten the hose clamps.
2. Fill the radiator with the recommended coolant mixture of 50% ethylene glycol and 50% clean, softened water to inhibit rust/corrosion and prevent freezing. The coolant capacity is shown in Figure 4-6.
3. Operate the engine with the radiator cap removed until the thermostat opens and the upper radiator hose becomes hot.
4. Stop the engine and allow it to cool.
5. Add coolant to the radiator to just below the overflow tube on the filler neck. See Section 1, Service Views, for the overflow tube location.
6. Replace the radiator's pressure cap.
7. Maintain the coolant level in the coolant overflow bottle between the High and Low markings. See Section 1, Service Views, for the coolant overflow bottle location.
8. Re-energize the block heater, if equipped.

## 4.7 Ignition System

---

### **⚠ WARNING**



**Airborne particles.**  
**Can cause severe injury or blindness.**

Wear protective goggles and clothing when using power tools, hand tools, or compressed air.

---

---

### **⚠ WARNING**

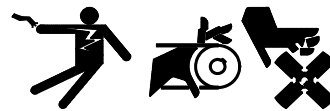

**Accidental starting.**  
**Can cause severe injury or death.**

Disconnect the battery cables before working on the generator set. Remove the negative (-) lead first when disconnecting the battery. Reconnect the negative (-) lead last when reconnecting the battery.

---

**Disabling the generator set. Accidental starting can cause severe injury or death.** Before working on the generator set or equipment connected to the set, disable the generator set as follows: (1) Press the generator set off/reset button to shut down the generator set. (2) Disconnect the power to the battery charger, if equipped. (3) Remove the battery cables, negative (-) lead first. Reconnect the negative (-) lead last when reconnecting the battery. Follow these precautions to prevent the starting of the generator set by the remote start/stop switch.

Service the spark plugs at the interval specified in the service schedule using the following procedure.

1. Press the OFF button on the RDC2 controller.
2. Disconnect the power to the battery charger.
3. Disconnect the generator set engine starting battery, negative (-) lead first.
4. Remove spark plug wires by grasping the spark plug boot and turning slightly while pulling. Do not pull the wire. Pulling on the wire rather than the boot may damage the wire or terminal.
5. Loosen the spark plug with a ratchet and 5/8-in. spark plug socket with a rubber insert to prevent spark plug damage.

6. Use compressed air to remove dirt from around each spark plug to prevent dirt particles from falling into the combustion chamber.
7. Remove spark plugs, one at a time, and examine. Identify a normal spark plug in good operating condition by observing a light tan or gray deposit on firing tip. See Figure 4-10 to evaluate engine condition by color/condition of a problem spark plug.

8. Clean spark plugs by wiping them with a rag. File the center electrode to keep it parallel to the side electrode.

**Note:** Do not sandblast, wire brush, scrape, or otherwise service spark plugs in poor condition. Obtain a new plug for best results.

9. Check the spark plug gap before installing any spark plug. See Figure 4-7 and Figure 4-8. Attain a correct gap when the feeler (or wire) passes between the spark plug electrode. It should pass easily but with some resistance or drag; otherwise adjust as necessary.

Model	Spark plug gap
38RCL, 48RCL, 48RCLA, and 60RCL	0.9 mm (0.035 in.)

**Figure 4-7** Recommended Spark Plug Gap

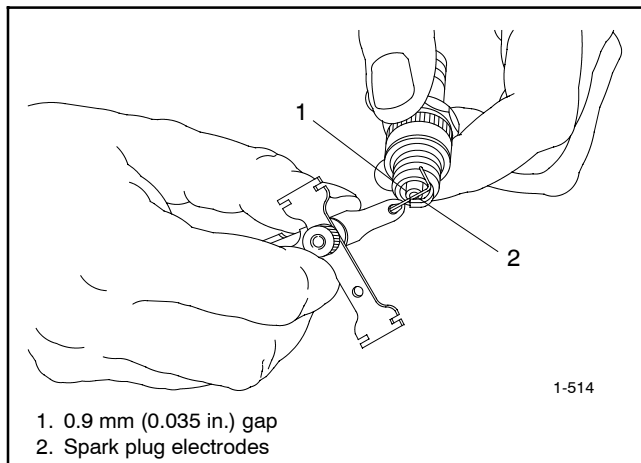

**Figure 4-8** Spark Plug Gap Inspection

10. Use a gapping tool to gently bend the side electrode closer to or farther from the center electrode to set the correct gap. See Figure 4-9. Position the side electrode directly over the center electrode.

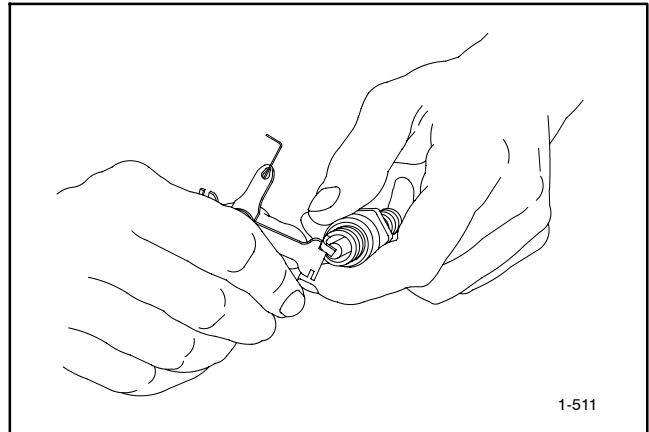

**Figure 4-9** Spark Plug Gap Adjustment

11. Reinstall the spark plug. Do not bump the electrode against the cylinder head. Rotate the spark plug clockwise until you feel resistance.
12. Use a torque wrench to torque each spark plug to 15 Nm (11 ft. lbs.). Otherwise, hand-tighten the spark plug until you feel resistance.
13. Use a ratchet wrench to final tighten an additional 1/4 turn. Do not overtighten, as doing so may strip the threads or alter the electrode gap setting.
14. Check the spark plug wire connector in the boot for accumulated dirt, grease, and other debris, and clean as necessary.
15. Firmly push the spark plug boot onto the spark plug.
16. Reconnect the generator set engine starting battery, negative (-) lead last.
17. Reconnect the power for the battery charger.

<b>Problem/Condition</b>	<b>Means of Identification</b>	<b>Possible Cause/Solution</b>
Gap-bridged spark plug	Built-up deposits and gap between electrodes closing.	Oil or carbon fouling. Clean and regap the spark plug.
Oil-fouled spark plug	Wet, black deposits on the insulator shell, bore, and electrodes.	Excessive oil entering combustion chamber through worn rings and pistons, excessive clearance between valve guides and stems, or worn or loose bearings. Replace the spark plug.
Carbon-fouled spark plug	Black, dry, fluffy carbon deposits on insulator tips, exposed shell surfaces and electrodes.	Incorrect spark plug, weak ignition, clogged air intake, overrich fuel mixture, or excessive no-load operation. Clean and regap the spark plug.
Lead-fouled spark plug	Dark gray, black, yellow, or tan deposits; or a glazed coating on the insulator tip.	Caused by highly leaded fuel. Replace the spark plug.
Pre-ignition damaged spark plug	Melted electrodes and possibly blistered insulator. Metallic deposits on insulator suggest internal engine damage.	Wrong type of fuel, incorrect timing or advance, too hot a plug, burned valves, or engine overheating. Replace the spark plug.
Overheated spark plug	White or light gray insulator with small black or gray/brown spots with bluish (burned) appearance on electrodes.	Engine overheating, wrong type of fuel, loose spark plugs, too hot a plug, low fuel pressure or incorrect ignition timing. Replace the spark plug.
Worn spark plug	Severely eroded or worn electrodes.	Caused by normal wear and failure to replace spark plug at prescribed interval. Replace the spark plug.

**Figure 4-10** Engine Evaluation Using Spark Plug Condition

## 4.8 Battery

Consult the battery manufacturer's instructions regarding battery care and maintenance.

---

### WARNING



**Sulfuric acid in batteries.  
Can cause severe injury or death.**

Wear protective goggles and clothing. Battery acid may cause blindness and burn skin.

---

**Battery electrolyte is a diluted sulfuric acid. Battery acid can cause severe injury or death.** Battery acid can cause blindness and burn skin. Always wear splashproof safety goggles, rubber gloves, and boots when servicing the battery. Do not open a sealed battery or mutilate the battery case. If battery acid splashes in the eyes or on the skin, immediately flush the affected area for 15 minutes with large quantities of clean water. Seek immediate medical aid in the case of eye contact. Never add acid to a battery after placing the battery in service, as this may result in hazardous spattering of battery acid.

**Battery acid cleanup. Battery acid can cause severe injury or death.** Battery acid is electrically conductive and corrosive. Add 500 g (1 lb.) of bicarbonate of soda (baking soda) to a container with 4 L (1 gal.) of water and mix the neutralizing solution. Pour the neutralizing solution on the spilled battery acid and continue to add the neutralizing solution to the spilled battery acid until all evidence of a chemical reaction (foaming) has ceased. Flush the resulting liquid with water and dry the area.

**Battery gases. Explosion can cause severe injury or death.** Battery gases can cause an explosion. Do not smoke or permit flames or sparks to occur near a battery at any time, particularly when it is charging. Do not dispose of a battery in a fire. To prevent burns and sparks that could cause an explosion, avoid touching the battery terminals with tools or other metal objects. Remove all jewelry before servicing the equipment. Discharge static electricity from your body before touching batteries by first touching a grounded metal surface away from the battery. To avoid sparks, do not disturb the battery charger connections while the battery is charging. Always turn the battery charger off before disconnecting the battery connections. Ventilate the compartments containing batteries to prevent accumulation of explosive gases.

**Battery short circuits. Explosion can cause severe injury or death.** Short circuits can cause bodily injury and/or equipment damage. Disconnect the battery before generator set installation or maintenance. Remove all jewelry before servicing the equipment. Use tools with insulated handles. Remove the negative (-) lead first when disconnecting the battery. Reconnect the negative (-) lead last when reconnecting the battery. Never connect the negative (-) battery cable to the positive (+) connection terminal of the starter solenoid. Do not test the battery condition by shorting the terminals together.

Refer to this section for general battery information and maintenance. Also consult the battery manufacturer's instructions for battery maintenance.

All generator set models use a negative ground with a 12-volt engine electrical system. Consult the generator set nameplate for the engine electrical system voltage. Consult the generator spec sheet for battery capacity recommendations for replacement purposes. Wiring diagrams provide battery connection information. See Figure 4-11 for typical battery connections.

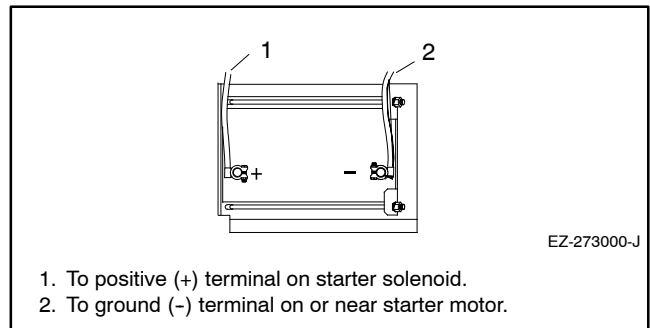

**Figure 4-11** 12-Volt Engine Electrical System Single Starter Motor, Typical Battery Connection

Clean the battery and cables and tighten battery terminals using the service schedule recommendations. To prevent corrosion, maintain tight, dry electrical connections at the battery terminals. To remove corrosion from battery terminals, disconnect the cables from the battery and scrub the terminals with a wire brush. Clean the battery and cables with a solution of baking soda and water. After cleaning, flush the battery and cables with clean water and wipe them with a dry, lint-free cloth.

After reconnecting the battery cables, coat the battery terminals with petroleum jelly, silicone grease, or other nonconductive grease.

### 4.8.1 Checking Electrolyte Level

Check the electrolyte level of batteries with filler caps monthly. Remove filler caps and verify that electrolyte level reaches bottom of filler holes. Refill as necessary with distilled water. DO NOT add fresh electrolyte. Tighten all filler caps. If water is added during freezing temperatures, run the generator set for 20–30 minutes to mix the electrolyte and water to prevent battery damage from freezing.

### 4.8.2 Checking Specific Gravity

Use a battery hydrometer to check the specific gravity of the electrolyte in each battery cell. While holding the hydrometer vertically, read the number on the glass bulb at the top of the electrolyte level or the number adjacent to the pointer. If the hydrometer used does not have a correction table, use the correction factors in Figure 4-14. Determine specific gravity and electrolyte temperature of battery cells. Locate temperature in Figure 4-14 and adjust the specific gravity by the amount shown.

The battery is fully charged if the specific gravity is 1.260 at an electrolyte temperature of 80°F (26.7°C). The difference between specific gravities of each cell should not exceed ±0.01. Charge the battery if the specific gravity is below 1.215 at an electrolyte temperature of 80°F (26.7°C). See Figure 4-12.

Specific Gravity, Corrected to 80°F (26.7°C)	Battery Condition
Below 1.215	Needs charging
1.260	Fully charged

Figure 4-12 Specific Gravity Interpretation

Some battery testers have four or five beads in the test tube. Draw electrolyte into the tube as performed with the battery hydrometer described previously. Use the manufacturer’s instructions. Figure 4-13 interprets typical test results.

Number of Floating Beads	Battery Condition
5	Overcharged
4	Fully charged
3	Good charge
1 or 2	Low charge
0	Dead battery

Figure 4-13 Bead-Type Test Interpretation

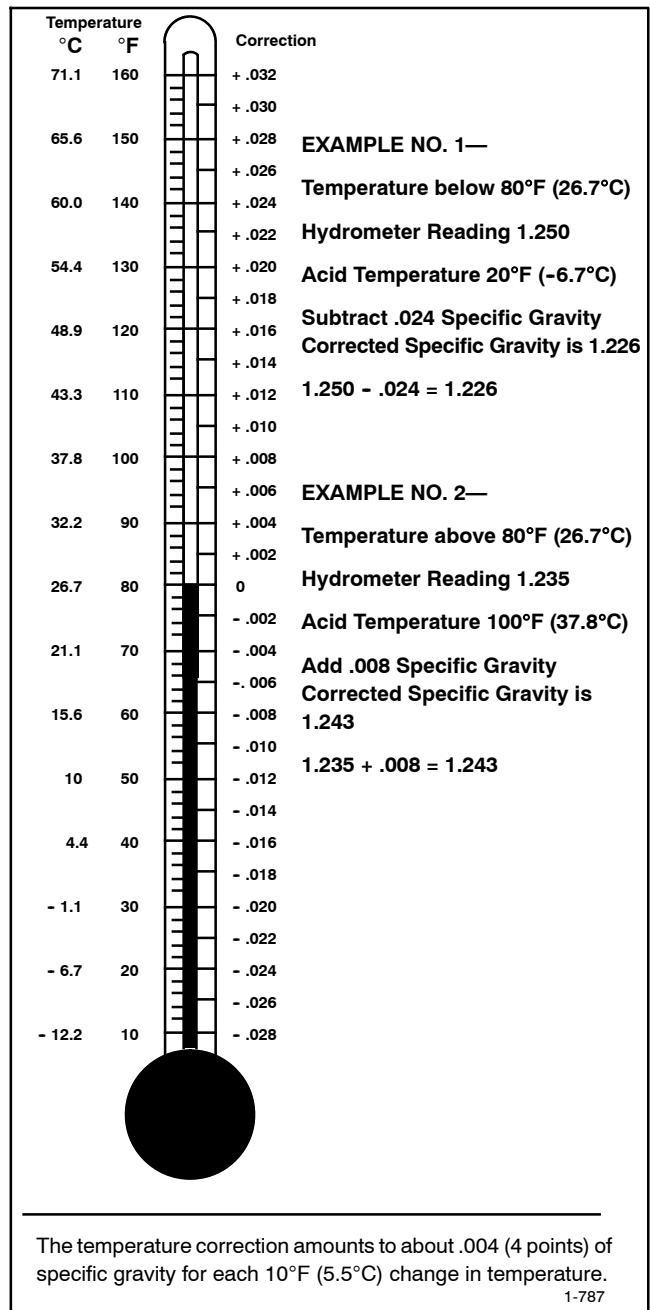
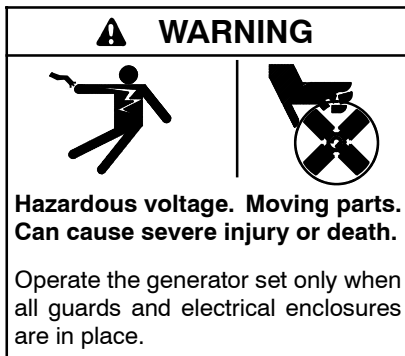
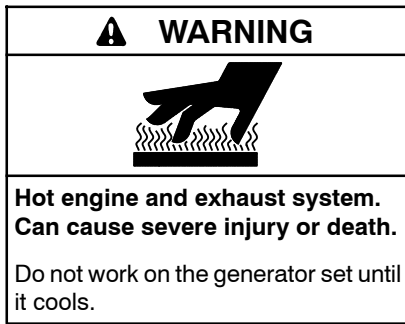

Figure 4-14 Specific Gravity Temperature Correction

## 4.9 Storage Procedure



Follow the procedure below when storing your generator set for a long period (3 months or more).

1. Start and run the generator set until it reaches operating temperature or about 15 minutes.
2. Stop the generator set.
3. Change the oil and oil filter; see Section 4.3.4, Oil and Filter Change.
4. Check the engine coolant protection; see Section 4.6.

**Note:** Use antifreeze capable of withstanding the lowest possible temperatures.

5. Keep spark plugs in their holes or seal spark plug holes with suitable threaded metal plugs.
6. Clean the exterior of the generator set and spread a light film of oil or silicon spray over any exposed surfaces that may be subject to rust or corrosion.
7. Seal the air inlet, exhaust pipe, and fuel tank cap with tape.
8. Disconnect and remove the battery. Place the battery in a warm, dry location for the storage period. Recharge the battery once a month to maintain a full charge.
9. Select a well-ventilated (not humid or dusty) location to store the generator.
10. Cover the entire unit with a dust cover.

**Note:** Run the generator set once a month whenever possible.

# Section 5 Troubleshooting

## 5.1 Introduction

Use the troubleshooting charts in this section to diagnose and correct common problems. First check for simple causes such as a dead engine starting battery, loose connections, or an open circuit breaker. The charts include a list of common problems, possible causes of the problem, and recommended corrective actions.

If the procedures in this manual do not explain how to correct the problem, contact an authorized Kohler distributor/dealer. Maintain a record of repairs and adjustments performed on the equipment. Use the record to help describe the problem and repairs or adjustments made to equipment.

## 5.2 USB Port

A USB port is located on the front of the controller. Use a USB cable with a mini-B connector to connect the controller to your personal computer (laptop).

Some controller settings can be adjusted using a laptop computer with Kohler® SiteTech™ software. SiteTech software is available to Kohler authorized distributors and dealers. See TP-6701, SiteTech™ Software Operation Manual, for more information.

## 5.3 Fault Messages

The RDC2 controller displays fault messages to aid in troubleshooting. Fault messages, descriptions, and recommended checks are listed in Figure 2-5.

Identify and correct the cause of the fault condition. Then reset the controller after a fault shutdown. See Section 2.6.4.

## 5.4 Circuit Protection

If the generator set circuit breaker trips or the fuses blow repeatedly, contact an authorized Kohler distributor/dealer for service.

### 5.4.1 Load Circuit Breaker

The load circuit breaker interrupts the generator output in the event of a fault in the wiring between the generator and the load. If the circuit breaker trips, reduce the load and switch the breaker back to the ON position. Refer to the service views in Section 1 for the location of the circuit breaker.

### 5.4.2 Fuses

Always identify and correct the cause of a blown fuse before restarting the generator set. Refer to Figure 5-1, Troubleshooting Chart, for conditions that may indicate a blown fuse. Obtain replacement parts and service from an authorized Kohler distributor/dealer.

**Fan Fuses.** Three 30 amp fan fuses are located in the fan fuse and relay box. See Section 1, Service Views, for location.

**Engine Fuses.** Engine fuses are located in the engine fuse box.

- Fuse F1, 5 amps
- Fuse F2, ECM 10 amps
- Fuse M3, battery charging alternator, 70 amps
- Fuse F4, ignition, 15 amps.
- Fuse F6, starter, 20 amps.

### 5.4.3 Controller Internal Circuit Protection

The controller is equipped with internal circuit protection. Press OFF to reset.

## 5.5 Generator Set Troubleshooting

Figure 5-1 contains generator set troubleshooting, diagnostic, and repair information. Check for loose connections before replacing parts.

**Note:** Read all safety precautions at the beginning of this publication before performing any work on the generator set.

Problem	Possible Cause	Corrective Action
The generator set does not crank.	Battery weak or dead.	Recharge or replace the battery.
	Battery connections reversed or poor.	Check the connections.
	Blown fuse(s).	Replace the fuse. Contact an authorized Kohler distributor/dealer for service if fuse blows repeatedly.
	Generator set is OFF.	Press the RUN button to start the engine or press AUTO to allow remote starting.
The generator set cranks but does not start, starts hard, lacks power, or operates erratically.	Air cleaner clogged.	Clean and/or replace the air cleaner.
	Battery weak or dead.	Recharge or replace the battery.
	Battery connection poor.	Clean and tighten the battery connections.
	Spark plug wire connection loose.	Check the spark plug wires.
	Low oil pressure shutdown.	Check for oil leaks. Check the oil level and add oil if necessary.
	Fuel pressure insufficient.	Check the fuel supply and valves.
	Engine fuse blown.	Replace the fuse. If the fuse blows again, contact an authorized Kohler distributor/dealer.
No AC output.	AC circuit breaker in the OFF position.	Place the circuit breaker in the ON position.
	AC circuit breaker tripping because of overload.	Reduce the load on the generator set.
	AC circuit breaker tripping because of short circuit.	Contact an authorized Kohler distributor/dealer for service.
	Engine fuse blown.	Replace the fuse. Contact an authorized Kohler distributor/dealer for service if fuse blows repeatedly.
Low output or excessive drop in voltage.	Generator set overloaded.	Reduce the load.
Generator set stops suddenly.	Low oil pressure shutdown.	Check for oil leaks. Check the oil level and add oil if necessary.
	Out of fuel.	Check fuel supply.
	Overcrank shutdown.	Reset the controller. If the overcrank fault occurs again, contact an authorized Kohler distributor/dealer.
	Blown fuse(s).	Replace the fuse. If the fuse blows again, contact an authorized Kohler distributor/dealer.
	Overspeed shutdown.	Reset the controller. If the overspeed fault occurs again, contact an authorized Kohler distributor/dealer.
	Generator set is OFF.	Press the RUN button to start the engine or press AUTO to allow remote starting.
	Remote stop command received from a remote switch, ATS, or OnCue®.	Check the remote switch position.
Fans run after engine shuts down.	Engine malfunction.	Contact an authorized Kohler distributor/dealer.
	The fans continue to run for 2 minutes after the engine shuts down to evacuate the engine compartment.	None.

**Figure 5-1** General Troubleshooting Chart



## 5.6 Controller Troubleshooting

Figure 5-2 contains basic troubleshooting information for the RDC2 controller.

Problem	Possible Cause	Corrective Action
Controller LCD display is off.	Low or no battery voltage.	Check connections. Check generator set battery. See Figure 5-1.
Controller display backlight is off.	Backlight turns off after about 1 minute with no activity.	Backlight will turn on when a button is pressed or the generator set starts.
Loss of communication to accessory modules	Bad connections.	Check wiring and connections. Verify that cable size and length of run comply with the instructions in the Installation manual.
	Low or no battery voltage.	Check battery connections. Check generator set battery. See Figure 5-1.
Load management relays do not operate.	Bad connections.	Check wiring and connections. Verify that cable size and length of run comply with the instructions in the Installation manual.
	Low or no battery voltage.	Check battery connections. Check generator set battery. See Figure 5-1.
Date is flashing.	Controller power was disconnected and then reconnected.	Check battery connections. See Figure 5-1. Check utility power connection for the built-in battery charger. Reset the time, date, and exercise schedule. See Section 2.5.7, Setting the Exerciser at Power-Up.

**Figure 5-2** RDC2 Troubleshooting Chart

# Notes

# Appendix A Abbreviations

The following list contains abbreviations that may appear in this publication.

A, amp	ampere	cfm	cubic feet per minute	exh.	exhaust
ABDC	after bottom dead center	CG	center of gravity	ext.	external
AC	alternating current	CID	cubic inch displacement	F	Fahrenheit, female
A/D	analog to digital	CL	centerline	FHM	flat head machine (screw)
ADC	advanced digital control; analog to digital converter	cm	centimeter	fl. oz.	fluid ounce
adj.	adjust, adjustment	CMOS	complementary metal oxide substrate (semiconductor)	flex.	flexible
ADV	advertising dimensional drawing	com	communications (port)	freq.	frequency
Ah	amp-hour	coml	commercial	FS	full scale
AHWT	anticipatory high water temperature	Coml/Rec	Commercial/Recreational connection	ft.	foot, feet
AISI	American Iron and Steel Institute	conn.	connection	ft. lb.	foot pounds (torque)
ALOP	anticipatory low oil pressure	cont.	continued	ft./min.	feet per minute
alt.	alternator	CPVC	chlorinated polyvinyl chloride	ftp	file transfer protocol
Al	aluminum	crit.	critical	g	gram
ANSI	American National Standards Institute (formerly American Standards Association, ASA)	CSA	Canadian Standards Association	ga.	gauge (meters, wire size)
AO	anticipatory only	CT	current transformer	gal.	gallon
APDC	Air Pollution Control District	Cu	copper	gen.	generator
API	American Petroleum Institute	cUL	Canadian Underwriter's Laboratories	genset	generator set
approx.	approximate, approximately	CUL	Canadian Underwriter's Laboratories	GFI	ground fault interrupter
APU	Auxiliary Power Unit	cu. in.	cubic inch	GND, ⊕	ground
AQMD	Air Quality Management District	cw.	clockwise	gov.	governor
AR	as required, as requested	CWC	city water-cooled	gph	gallons per hour
AS	as supplied, as stated, as suggested	cyl.	cylinder	gpm	gallons per minute
ASE	American Society of Engineers	D/A	digital to analog	gr.	grade, gross
ASME	American Society of Mechanical Engineers	DAC	digital to analog converter	GRD	equipment ground
assy.	assembly	dB	decibel	gr. wt.	gross weight
ASTM	American Society for Testing Materials	dB(A)	decibel (A weighted)	H x W x D	height by width by depth
ATDC	after top dead center	DC	direct current	HC	hex cap
ATS	automatic transfer switch	DCR	direct current resistance	HCHT	high cylinder head temperature
auto.	automatic	deg., °	degree	HD	heavy duty
aux.	auxiliary	dept.	department	HET	high exhaust temp., high engine temp.
avg.	average	dia.	diameter	hex	hexagon
AVR	automatic voltage regulator	DI/EO	dual inlet/end outlet	Hg	mercury (element)
AWG	American Wire Gauge	DIN	Deutsches Institut für Normung e. V. (also Deutsche Industrie Normenausschuss)	HH	hex head
AWM	appliance wiring material	DIP	dual inline package	HHC	hex head cap
bat.	battery	DPDT	double-pole, double-throw	HP	horsepower
BBDC	before bottom dead center	DPST	double-pole, single-throw	hr.	hour
BC	battery charger, battery charging	DS	disconnect switch	HS	heat shrink
BCA	battery charging alternator	DVR	digital voltage regulator	hsg.	housing
BCI	Battery Council International	E <sup>2</sup> PROM, EEPROM	electrically-erasable programmable read-only memory	HVAC	heating, ventilation, and air conditioning
BDC	before dead center	E, emer.	emergency (power source)	HWT	high water temperature
BHP	brake horsepower	ECM	electronic control module, engine control module	Hz	hertz (cycles per second)
blk.	black (paint color), block (engine)	EDI	electronic data interchange	IBC	International Building Code
blk. htr.	block heater	EFR	emergency frequency relay	IC	integrated circuit
BMEP	brake mean effective pressure	e.g.	for example ( <i>exempli gratia</i> )	ID	inside diameter, identification
bps	bits per second	EG	electronic governor	IEC	International Electrotechnical Commission
br.	brass	EGSA	Electrical Generating Systems Association	IEEE	Institute of Electrical and Electronics Engineers
BTDC	before top dead center	EIA	Electronic Industries Association	IMS	improved motor starting
Btu	British thermal unit	EI/EO	end inlet/end outlet	in.	inch
Btu/min.	British thermal units per minute	EMI	electromagnetic interference	in. H <sub>2</sub> O	inches of water
C	Celsius, centigrade	emiss.	emission	in. Hg	inches of mercury
cal.	calorie	eng.	engine	in. lb.	inch pounds
CAN	controller area network	EPA	Environmental Protection Agency	Inc.	incorporated
CARB	California Air Resources Board	EPS	emergency power system	ind.	industrial
CAT5	Category 5 (network cable)	ER	emergency relay	int.	internal
CB	circuit breaker	ES	engineering special, engineered special	int./ext.	internal/external
CC	crank cycle	ESD	electrostatic discharge	I/O	input/output
cc	cubic centimeter	est.	estimated	IP	internet protocol
CCA	cold cranking amps	E-Stop	emergency stop	ISO	International Organization for Standardization
ccw.	counterclockwise	etc.	et cetera (and so forth)	J	joule
CEC	Canadian Electrical Code			JIS	Japanese Industry Standard
cert.	certificate, certification, certified			k	kilo (1000)
cfh	cubic feet per hour			K	kelvin
				kA	kiloampere
				KB	kilobyte (2 <sup>10</sup> bytes)
				KBus	Kohler communication protocol
				kg	kilogram

kg/cm <sup>2</sup>	kilograms per square centimeter	NC	normally closed	RTU	remote terminal unit
kgm	kilogram-meter	NEC	National Electrical Code	RTV	room temperature vulcanization
kg/m <sup>3</sup>	kilograms per cubic meter	NEMA	National Electrical Manufacturers Association	RW	read/write
kHz	kilohertz	NFPA	National Fire Protection Association	SAE	Society of Automotive Engineers
kJ	kilojoule	Nm	newton meter	scfm	standard cubic feet per minute
km	kilometer	NO	normally open	SCR	silicon controlled rectifier
kOhm, kΩ	kilo-ohm	no., nos.	number, numbers	s, sec.	second
kPa	kilopascal	NPS	National Pipe, Straight	SI	<i>Systeme international d'unites</i> , International System of Units
kph	kilometers per hour	NPSC	National Pipe, Straight-coupling	SI/EO	side in/end out
kV	kilovolt	NPT	National Standard taper pipe thread per general use	sil.	silencer
kVA	kilovolt ampere	NPTF	National Pipe, Taper-Fine	SMTP	simple mail transfer protocol
kVAR	kilovolt ampere reactive	NR	not required, normal relay	SN	serial number
kW	kilowatt	ns	nanosecond	SNMP	simple network management protocol
kWh	kilowatt-hour	OC	overcrank	SPDT	single-pole, double-throw
kWm	kilowatt mechanical	OD	outside diameter	SPST	single-pole, single-throw
kWth	kilowatt-thermal	OEM	original equipment manufacturer	spec	specification
L	liter	OF	overfrequency	specs	specification(s)
LAN	local area network	opt.	option, optional	sq.	square
L x W x H	length by width by height	OS	oversize, overspeed	sq. cm	square centimeter
lb.	pound, pounds	OSHA	Occupational Safety and Health Administration	sq. in.	square inch
lbm/ft <sup>3</sup>	pounds mass per cubic feet	OV	overvoltage	SMS	short message service
LCB	line circuit breaker	oz.	ounce	SS	stainless steel
LCD	liquid crystal display	p., pp.	page, pages	std.	standard
LED	light emitting diode	PC	personal computer	stl.	steel
Lph	liters per hour	PCB	printed circuit board	tach.	tachometer
Lpm	liters per minute	pF	picofarad	TB	terminal block
LOP	low oil pressure	PF	power factor	TCP	transmission control protocol
LP	liquefied petroleum	ph., ∅	phase	TD	time delay
LPG	liquefied petroleum gas	PHC	Phillips® head CrimpTite® (screw)	TDC	top dead center
LS	left side	PHH	Phillips® hex head (screw)	TDEC	time delay engine cooldown
L <sub>wa</sub>	sound power level, A weighted	PHM	pan head machine (screw)	TDEN	time delay emergency to normal
LWL	low water level	PLC	programmable logic control	TDES	time delay engine start
LWT	low water temperature	PLC	programmable logic control	TDNE	time delay normal to emergency
m	meter, milli (1/1000)	PMG	permanent magnet generator	TDOE	time delay off to emergency
M	mega (10 <sup>6</sup> when used with SI units), male	pot	potentiometer, potential	TDON	time delay off to normal
m <sup>3</sup>	cubic meter	ppm	parts per million	temp.	temperature
m <sup>3</sup> /hr.	cubic meters per hour	PROM	programmable read-only memory	term.	terminal
m <sup>3</sup> /min.	cubic meters per minute	psi	pounds per square inch	THD	total harmonic distortion
mA	milliampere	psig	pounds per square inch gauge	TIF	telephone influence factor
man.	manual	pt.	pint	tol.	tolerance
max.	maximum	PTC	positive temperature coefficient	turbo.	turbocharger
MB	megabyte (2 <sup>20</sup> bytes)	PTO	power takeoff	typ.	typical (same in multiple locations)
MCCB	molded-case circuit breaker	PVC	polyvinyl chloride	UF	underfrequency
MCM	one thousand circular mils	qt.	quart, quarts	UHF	ultrahigh frequency
megggar	megohmmeter	qty.	quantity	UIF	user interface
MHz	megahertz	R	replacement (emergency)	UL	Underwriter's Laboratories, Inc.
mi.	mile	rad.	radiator, radius	UNC	unified coarse thread (was NC)
mil	one one-thousandth of an inch	RAM	random access memory	UNF	unified fine thread (was NF)
min.	minimum, minute	RBUS	RS-485 proprietary communications	univ.	universal
misc.	miscellaneous	RDO	relay driver output	URL	uniform resource locator (web address)
MJ	megajoule	ref.	reference	US	undersize, underspeed
mJ	millijoule	rem.	remote	UV	ultraviolet, undervoltage
mm	millimeter	Res/Coml	Residential/Commercial	V	volt
mOhm, mΩ	milliohm	RFI	radio frequency interference	VAC	volts alternating current
MOhm, MΩ	megohm	RH	round head	VAR	voltampere reactive
MOV	metal oxide varistor	RHM	round head machine (screw)	VDC	volts direct current
MPa	megapascal	rly.	relay	VFD	vacuum fluorescent display
mpg	miles per gallon	rms	root mean square	VGA	video graphics adapter
mph	miles per hour	rnd.	round	VHF	very high frequency
MS	military standard	RO	read only	W	watt
ms	millisecond	ROM	read only memory	WCR	withstand and closing rating
m/sec.	meters per second	rot.	rotate, rotating	w/	with
mtg.	mounting	rpm	revolutions per minute	WO	write only
MTU	Motoren-und Turbinen-Union	RS	right side	w/o	without
MW	megawatt	RTDs	Resistance Temperature Detectors	wt.	weight
mW	milliwatt			xfmr	transformer
μF	microfarad				
N, norm.	normal (power source)				
NA	not available, not applicable				
nat. gas	natural gas				
NBS	National Bureau of Standards				

# Notes

# Notes



# **KOHLER**<sup>®</sup> Power Systems

KOHLER CO. Kohler, Wisconsin 53044  
Phone 920-457-4441, Fax 920-459-1646

Kohler Power Systems  
Asia Pacific Headquarters  
7 Jurong Pier Road  
Singapore 619159  
Phone (65) 6264-6422, Fax (65) 6264-6455

**For the nearest KOHLER authorized  
installation, service, and sales dealer in  
the US and Canada:  
Call 1-800-544-2444 or visit  
KOHLERPower.com**

**TP-6810 7/16d**

*Original Instructions (English)*

© 2012, 2013, 2015, 2016 by Kohler Co. All rights reserved.