

Mira Elite ST

9.8, 10.8 kW

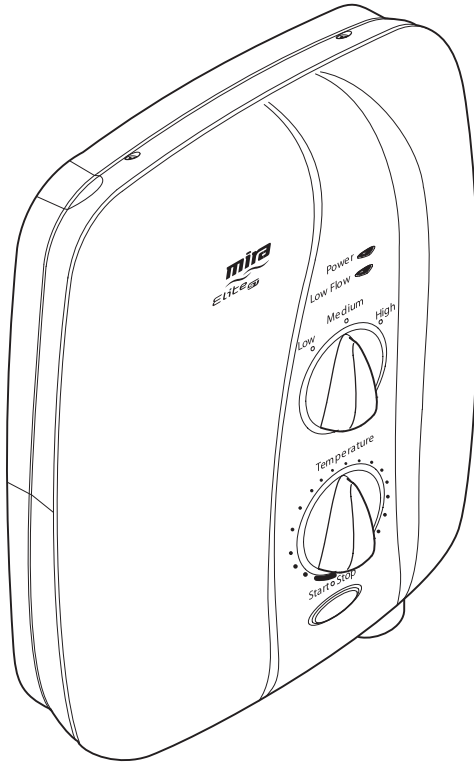

These instructions must be left with the user

Installation Guide

Showering perfection

mira
SHOWERS

INTRODUCTION

Thank you for purchasing a quality Mira product. To exploit the full potential of your new product, please take time to read this guide thoroughly. Having done so, keep it handy for future reference.

The Mira Elite ST is a tank-fed (cistern-fed) pumped electric shower for use where the mains water supply pressure is too low, unreliable or non-existent, to operate a conventional electric shower.

The Mira Elite ST features an internal pump unit which has been designed to provide all year round performance, even at the highest flow rates which are necessary during the summer months. The Elite ST has separate controls for power selection and temperature/flow adjustment. The Elite ST must have its own separate cold water supply from the cistern to ensure correct operation.

Mira Elite ST models covered by this guide:

Mira Elite ST 9.8 - A 9.8 kW @ 240 Volts AC (9.0 kW @ 230 Volts AC) heater. Available in white/chrome or satin/chrome finishes.

Mira Elite ST 10.8 - A 10.8 kW @ 240 Volts AC (9.9 kW @ 230 Volts AC) heater. Available in a white/chrome finish.

Guarantee

For **domestic installations**, Mira Showers guarantee the Mira Elite ST against any defect in materials or workmanship for a period of **two** years from the date of purchase (shower fittings for one year).

For **non-domestic installations**, Mira Showers guarantee the Mira Elite ST against any defect in materials or workmanship for a period of **one** year from the date of purchase.

For terms and conditions refer to the back cover of this guide.

Recommended Usage	
Domestic	✓
Light Commercial	✓
Heavy Commercial	✗
Healthcare	✗

Patents

Patents:	GB:2 289 323, 2 341 667, 2 359 339, 2 427 460, 2 432 201 Ireland: 80655, 82835, 83692
Patent Applications:	Ireland: 2006/0462, 2006/0818

If you experience any difficulty with the installation or operation of your new Electric Shower, please refer to '**Fault Diagnosis**', before contacting Kohler Mira Ltd. Our contact details can be found on the back cover of this guide.

IMPORTANT SAFETY INFORMATION

WARNING - This shower can deliver scalding temperatures if not operated, installed or maintained in accordance with the instructions, warnings and cautions contained in this guide and on or inside the appliance.

1. Installation of this shower must be carried out in accordance with these instructions, and must be conducted by competent personnel.
2. Isolate the electrical and water supplies before commencing installation. The electricity must be switched off at the consumer unit and the appropriate circuit fuse removed, if applicable.
3. Mains connections are exposed when the cover is removed.
4. The electrical installation must comply with BS 7671 (commonly referred to as the IEE Wiring Regulations) and all relevant building regulations, or any particular regulation or practice specified by the local electricity supply company.
5. The plumbing installation must comply with all national or local water regulations and all relevant building regulations, or any particular regulation or practice specified by the local water supply company.
6. This shower is intended to be permanently connected to the fixed electrical wiring of the mains system. A separate supply must be provided from the consumer unit to the shower.
7. This shower must be provided with means for disconnection that is incorporated into the fixed wiring in accordance with the relevant local wiring regulations. The isolating switch must be local to the appliance and may be a ceiling mounted pullcord type or a wall mounted switch fitted in an appropriate zone area.
8. In accordance with BS7671 a 30mA Residual Current Device (RCD) **must** be fitted. This may be part of the consumer unit or a separate unit.
9. This shower must be earthed. Ensure any supplementary bonding complies with the relevant regulations.
10. Ensure all electrical connections are tight, to prevent overheating.
11. This shower must not be fitted where it may be exposed to freezing conditions. Ensure that any pipe-work that could become frozen is properly insulated.
12. This shower is not suitable for areas with high humidity or temperature (i.e. steam rooms and saunas).
13. Mains connections are exposed when the cover is removed, only a competent person should remove the front cover. We recommend any maintenance work is carried out by a Mira Service Engineer or suitably qualified tradesperson. There are no user serviceable parts inside the shower.
14. **DO NOT** switch on if water leaks from the shower case. Isolate the electrical supply to the shower immediately.
15. **DO NOT** switch on if there is a possibility that the water in the shower is frozen.
16. **DO NOT** connect the outlet of the shower to any tap, control valve, trigger handset or showerhead other than those specified for use with this shower. Only Kohler Mira recommended accessories should be used.

17. Electric showers can deliver scalding temperatures if not operated, installed or maintained in accordance with the instructions, warnings and cautions contained in this guide and on or inside the shower.
18. Rapid or excessive operation of the shower controls may result in high or unstable outlet water temperatures. Operate controls gradually and allow 10-15 seconds to stabilise checking the temperature before entering the shower.
19. This shower is not intended for use by persons (including children) with reduced physical, sensory or mental capabilities, or lack of experience and knowledge, unless they have been given supervision or instruction concerning the use of the shower by a person responsible for their safety.
20. Children should be supervised to ensure that they do not play with the shower.
21. Always switch off the shower at the electrical isolating switch when not in use.
22. The showerhead must be de-scaled regularly.
23. **DO NOT** allow the handset to spray water directly on to the shower. Eg. When cleaning shower control.
24. If the shower is not to be used for a long period, the water supply to the shower must be isolated. If the shower or pipe-work is at risk of freezing during this period, they should also be drained of water.

If any of the following conditions occur, isolate the electricity and water supplies and refer to “To contact us”, on the back page of this guide.

- If the cover is not correctly fitted and water has entered the shower case
- If the case is damaged
- If the shower begins to make an odd noise, smell or smoke
- If the shower shows signs of a distinct change in performance indicating a need for maintenance
- If the shower is frozen

PACK CONTENTS CHECKLIST

Tick the appropriate boxes to familiarise yourself with the part names and to confirm that the parts are included.

1 x Case Insert

1 x Mira Elite ST

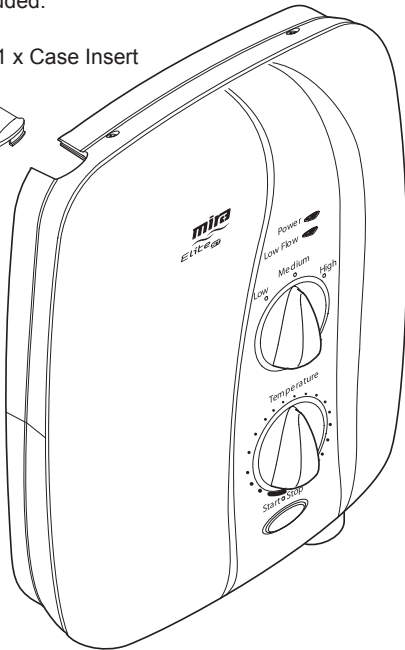

3 x Rubber Feet



1 x Olive



1 x Compression Nut

Documentation

1 x Installation and User Guide

1 x Guarantee Registration Document

WIRING DIAGRAM

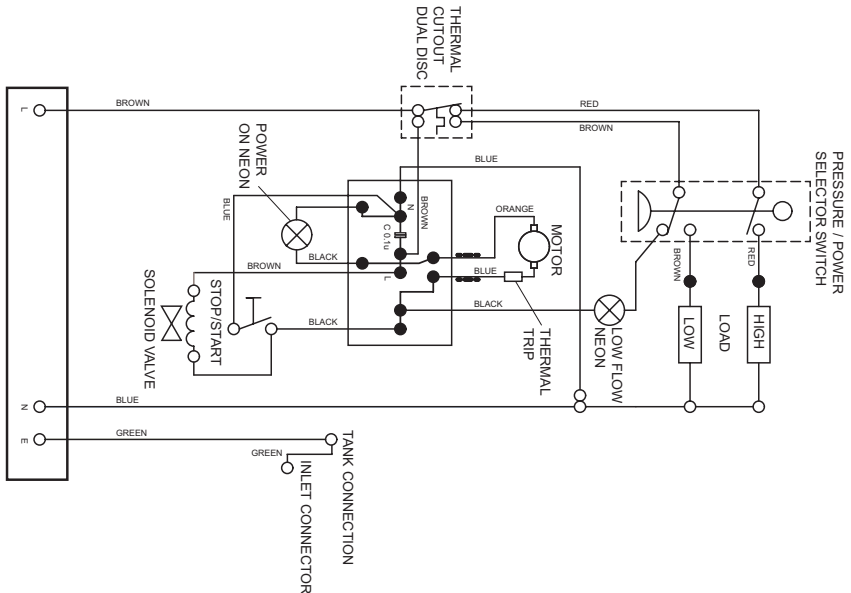

SPECIFICATIONS

1. Plumbing

1.1 The 15 mm inlet compression connector incorporates an inlet filter. The inlet swivels to allow top, bottom or rear entry.

Note! Whilst bottom entry is possible it is not recommended as it may encourage airlocks.

1.2 The outlet terminates with a 1/2" BSP male thread for connection to a Mira flexible shower hose.

2. Electrical

This is a high power unit, it is essential to contact your electricity supply company to make sure that the electricity supply is adequate for the purpose.

2.1 The terminal block will not accept cable larger than 16 mm².
The minimum required supply cable size must conform to BS 7671.

2.2 The motor is fitted with a self resetting thermal trip protection device, designed to operate if the ambient temperatures become too high. The maximum recommended ambient temperature for the Elite ST is 30°C.

2.3 The following power ratings for the heater tanks are available with their respective voltages:

Mira Elite ST 9.8 kW @ 240 V / 45 Amps (9.0 kW @ 230 V / 40 Amps).

Mira Elite ST 10.8 kW @ 240 V / 45 Amps (9.9 kW @ 230 V / 45 Amps).

2.4 The motor will absorb approximately 100 Watts maximum power under normal working conditions.

2.5 The Mira Elite ST is suitable for installation within zone 1 and is rated IP X4.

3. Standards and Approvals

3.1 This Mira Elite ST complies with all relevant directives for CE marking.

Dimensions	
Height	340 mm
Width	266 mm
Depth	95 mm

INSTALLATION REQUIREMENTS

1. Plumbing

Read the section '**Important Safety Information**' first.

1.1 The Elite ST is designed to operate with gravity fed water supplies providing pressures from 0.8 kPa * (0.008 bar / 80 millimetres head) to 100 kPa (1 bar / 10 metres head) (i.e. the vertical distance from the base of the cold cistern to the top of the Elite ST). The unit should never be fitted to a mains supply or where the above maximum pressure may be exceeded. Failure to comply with this may result in product damage leading to significant uncontrolled leakage from the unit.

- * Note: In practice the minimum head required will increase with pipe length and the guide given in paragraph 1.17 should be used to make sure that adequate head is available for any given installation.

The Elite ST **MUST** have its own separate supply from the cistern.

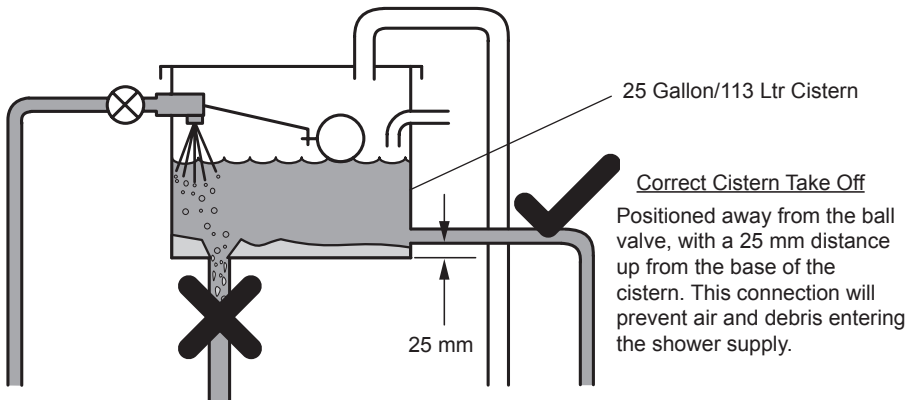

Incorrect Cistern Take Off

Debris from the bottom of the cistern and air generated when the cistern refills will enter the shower supply.

1.2 The Elite ST is suitable for installation within the shower area and is fitted with a pressure relief valve. It must be positioned over a water catchment area with the controls at a convenient height. The shower fitting should be positioned so that it discharges down the centre line of the bath, or across the opening of a shower cubicle, and must be directed away from the shower unit.

- 1.3** Use a minimum of 15 mm diameter supply pipework. It should be noted, however, that on long pipe runs this should be increased to 22 mm (refer to para 1.17 for guidance). When using flexible plastic pipe it is essential that the pipe is kept flat and not looped up at any point as this may lead to air build up
- 1.4** A non restrictive (free flowing) isolating valve should be fitted into the supply from the cold water cistern, for maintenance purposes.
- 1.5** The Elite ST must be fitted to a tiled or sealed finished surface . **DO NOT** block the air ventilation gaps around the sides of the unit, either by tiling up to the sides of the unit or by using a sealant around the case.
Important! This Elite ST is designed to be ventilated. Failure to do this may cause product failure.
Note! The Mira Elite ST is fitted with a pump motor, and some mechanical noise can be expected in addition to the noise generated by the spray from the handset. The type of wall surface will affect the perceived sound levels. Stud partition and panel walls have a tendency to resonate, whilst solid walls provide the quietest operation. The tone of the pump motor may change when the temperature control knob is adjusted. This is quite normal.
- 1.6** Inlet: 15 mm inlet compression connector is designed to accept plumbing supplies from the top, bottom or rear.
- 1.7** Rear entry plumbing is accommodated without the need to recess the 15 mm inlet compression connector. If pipework and/or electrical cables enter the shower from the rear through a hole in the wall provision must be made to prevent water ingress back into the wall structure.
- 1.8** Swivel the inlet connector assembly to suit (not directly back into the wall). Avoid trapping the green earth bonding wire.
- 1.9** Use only the 15 mm inlet compression connector supplied with the Elite ST, do not use any other types of fitting.
- 1.10** Outlet: 1/2" BSP male, to accept Mira flexible hose.
- 1.11** To ensure the case and other components are not put under strain during installation always provide mechanical support when making plumbing connections. Upon completion of the installation ensure connections and back case are not under any stress due to misaligned pipework or electrical cables.
Note! Excessive force on the pump housing can impair pumping performance.

Make sure that the supply pipe is trimmed and bent such that the 15 mm inlet connector sits (or can be lightly pressed) easily on the back of the clamp bracket prior to connection with the pump housing.

- 1.12** To avoid damage to the case when soldered fittings are used, pre-solder the pipework and fittings before connecting them to the inlet connector assembly..
- 1.13** Supply pipework **MUST** be flushed to clear debris before connecting the Elite ST.
- 1.14** A hose retaining ring is supplied to prevent the handset from dropping below the spillover level of the bath or shower, which could lead to contamination from back-siphonage (refer to illustration). The supplied hose retaining ring should meet the great majority of user requirements for shower installations with flexible outlet fittings. However, there will be occasions when the hose retaining ring will not provide a suitable solution. In these instances an **outlet** double checkvalve, e.g. the Mira DCV-H, **must** be fitted. The inclusion of the Mira DCV-H will increase the required supply pressure typically by 10 kPa (0.1 bar).

Double checkvalves, fitted in the inlet supply to the appliance, cause a pressure build-up, which could exceed the maximum static inlet pressure for the appliance.

- 1.15** When installed in very hard water areas (above 200 ppm temporary hardness) your installer may advise the installation of a water treatment device, to reduce the effects of limescale formation. Your local water company will be able to advise the hardness of water in your area.

- 1.16** Avoid layouts where the hose will be sharply kinked. This may reduce the life of the hose.

- 1.17** Long pipe runs and excessive use of 90° elbows will significantly reduce the available head to supply the Elite ST. The pipework table should be completed to ensure that adequate head is available for any given application.

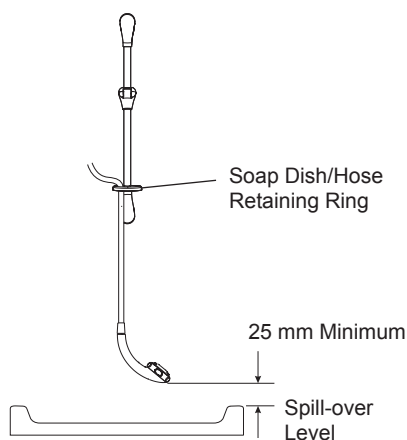

Pipework

The dimension (x) is calculated from the table below to give you a minimum effective head of 80 mm which is necessary to produce a satisfactory shower in all conditions.

Plumbing Schematic Diagram

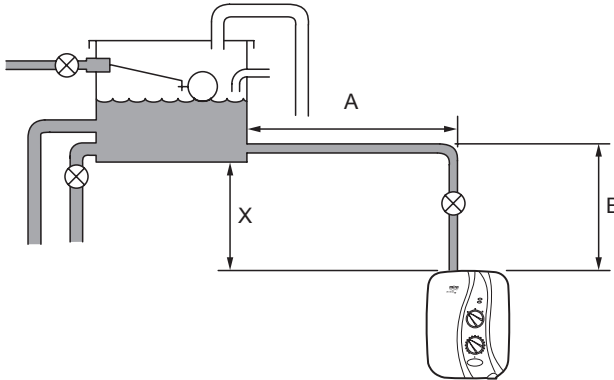

Example! The example below is based on the diagram above with 15 mm pipework, A = 1.5 m, B = 0.75 m.

Size	Quantity	Head Loss (mm)
15 mm Pipe	(A) <u>1.5</u> + (B) <u>0.75</u> = <u>2.25</u> x 120	270
22 mm Pipe	(A) <u> </u> + (B) <u> </u> = <u> </u> x 20	
15 mm Elbow	Number of Elbows <u>1</u> x 55	55
22 mm Elbow	Number of Elbows <u> </u> x 15	
	Minimum Effective Head	80
	(x) mm	405

2. Electrical

Read the section '**Important Safety Information**' first.

Checklist

2.1.1 Electrical supply fuse and consumer unit are adequate for the product.

2.1.2 Shower unit is earthed.

Caution! For the Mira Elite ST 10.8 kW model the minimum required supply cable size is 10 mm².

2.1.3 The minimum required supply cable size must conform to BS 7671.

Note! The terminal block will not accept cable larger than 16 mm².

2.1.4 Double pole isolating switch.

2.1.5 Do not twist live or neutral cable cores.

2.1.6 Electrical connections are tightly secured.

Do not strain terminal block.

2.1.7 Plumbing supply completed before electrical supply is turned on.

2.1.8 Unless otherwise stated, electrical equipment such as extractor fans, pumps must not be connected via this product.

Plumbing and Electrical Schematic Diagram

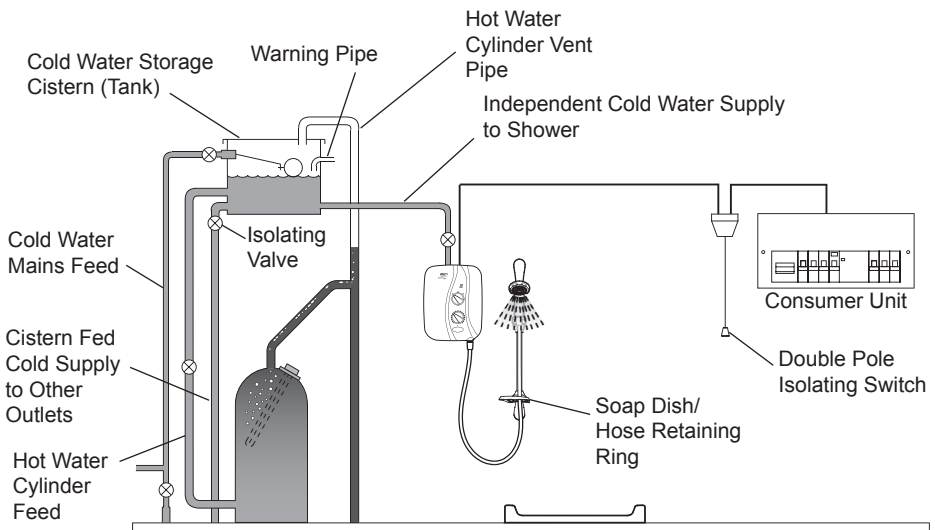

2.2 Electrical (checklist in detail)

2.2.1 In a domestic installation, the rating of the electricity supplier's fuse and the consumer unit must be adequate for the additional demand. The Mira Elite ST is a high power unit, therefore it is essential to contact your electricity supplier to ensure that the supply is adequate for the product. Voltage drop due to local heavy demand will reduce the shower's performance.

2.2.2 The Mira Elite ST **must be earthed** by connecting the supply-cable earth conductor to the earth terminal.

Supplementary bonding: Within the bathroom or shower room, all accessible conductive parts of electrical equipment and extraneous conductive parts (metal parts) that are likely to introduce earth potential, must be electrically bonded to earth using a minimum cable size of 4.0 mm² if the cable is not mechanically protected, (2.5 mm² if mechanically protected).

2.2.3 Supply cable - refer to: '**Electrical Checklist**'.

2.2.4 As a guide only, and in accordance with BS 7671 we recommend close circuit protection:

i.e. 9.8 kW @ 240 V = 45 Amp (9.0 kW @ 230 V = 40 Amp).
 10.8 kW @ 240 V / 45 Amps (9.9 kW @ 230 V / 45 Amps).

A 30m Residual Current Device (RCD) MUST be included in the electrical circuit. This may be part of the consumer unit or a separate unit.

A separate, permanently connected supply must be taken from the consumer unit to the appliance through a double-pole switch, which has at least 3 mm contact separation. The switch can be a ceiling mounted pullcord type within the shower room or a wall mounted switch fitted in the applicable zone area.

2.2.5 DO NOT twist the individual cable cores of either the live or neutral conductors, as this will prevent them from entering the terminal block.

2.2.6 DO NOT exert strain on the terminal block. Ensure that the electrical connections are tightly screwed down.

2.2.7 DO NOT turn on the electrical supply until the plumbing has been completed.

INSTALLATION

Read the section 'Important Safety Information' first.

1.



Electrical supply is turned off at the mains.

2.

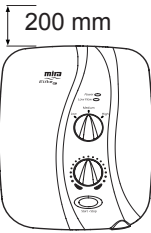

200 mm minimum gap from ceiling.

3.

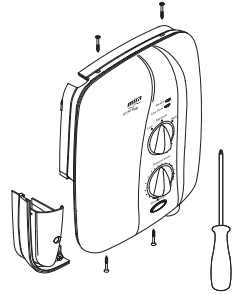

Remove the four cover screws.

4.

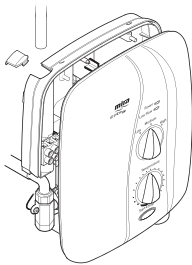

Remove the cover and determine supply pipe position.

5.

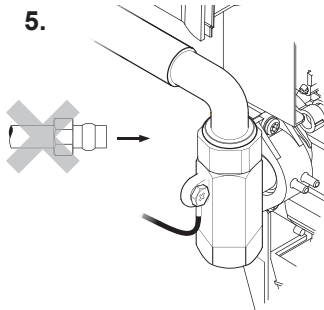

For rear inlet, use soldered elbow. **Do not** trap green wire.

6.

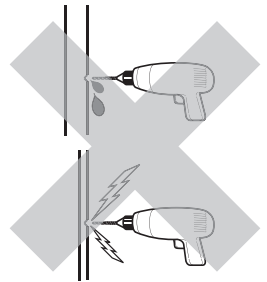

CAUTION! Do not drill into buried cables or pipes.

7.

Hold the product on the wall in the desired location and mark the positions of the fixing holes. Remove the product from the wall. Drill the three holes.

(Wall fixings are not supplied. For solid wall structures a red rawl plug and a no. 8 x 1½" countersunk brass or stainless steel screw should be used. For other wall structures such as panels alternative fixings may be required. A minimum of 3 fixing screws should be used)

8.

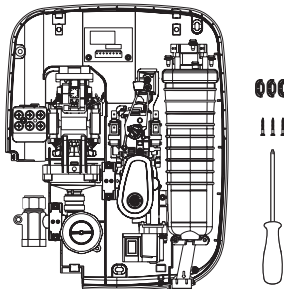

Fit Rubber Feet and fix appliance to wall.

9.

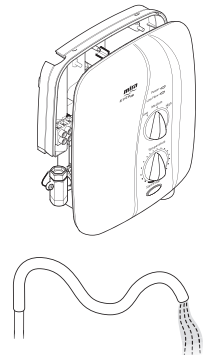

Flush a minimum of 10 litres through pipework.

10.

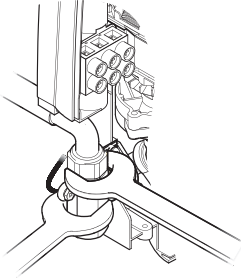

Connect supply pipe. **Do not overtighten!**

11.

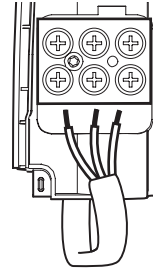

Feed cable into Case. Fit Earth sleeve (not supplied) and strip insulation.

Do not twist cable cores.

12.

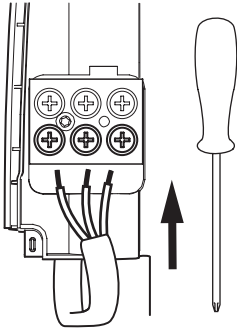

L = BROWN
E = GREEN
N = BLUE

Firmly connect the conductors. **Do not** exert strain on the terminal block.

13.

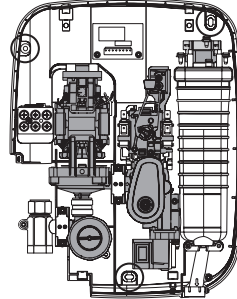

Make sure wires are clear of all mounting holes.

14.

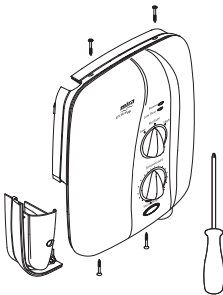

Refit the Service Tunnel and Cover. Make sure they fit correctly. **Do not** overtighten screws.

15.

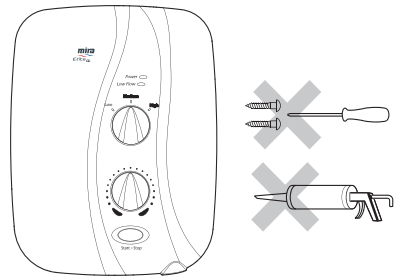

Do not use alternative screws to secure the Cover. This can cause internal damage to the appliance.

Do not seal around the back of appliance.

Having completed the installation make sure the user is familiar with the operation of the appliance.

COMMISSIONING

Before carrying out the commissioning procedure install the Shower Fittings, refer to the Shower Fittings Installation and User Guide.

If you are unsure how an electric shower works, please read through the **User Instructions** section before continuing.

1. 

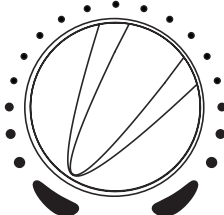
Electrical supply is turned off at the mains.
2. 

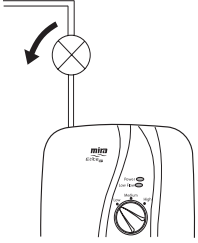
Turn **BOTTOM** control to full cold.
3. 

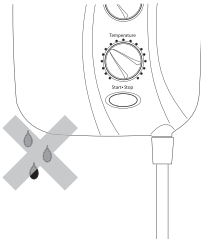
Turn water supply fully on.
4. 

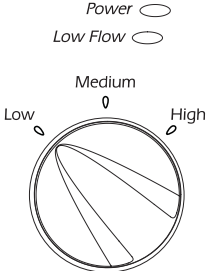
Check for water leaks.
5. 

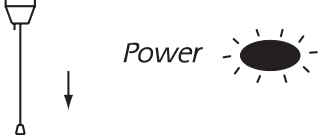
Turn **TOP** control to **LOW**.
6. 

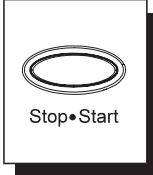
Switch on electrical supply.
7. 

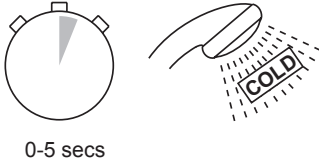
Push **START** button.
8. 

Water will be at full force and at a cool temperature.
9. 

Turn **BOTTOM** control slowly. Temperature remains cool and flow is reduced.

10.

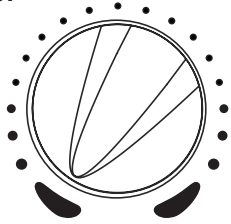

Turn **BOTTOM** control to full cold.

11.

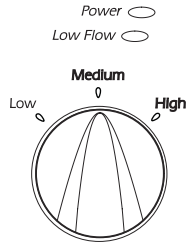

Set the **TOP** control to **MEDIUM**.

12.



0-5 secs

The temperature will rise slightly.

13.

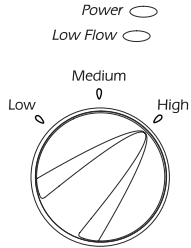

Set the **TOP** control to **HIGH**.

14.



0-5 secs

The temperature will rise further.

15.

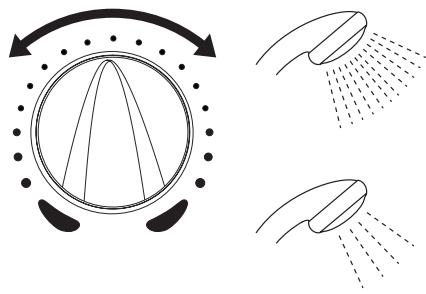

Adjust temperature as required.
Flow rate will adjust automatically.

16.

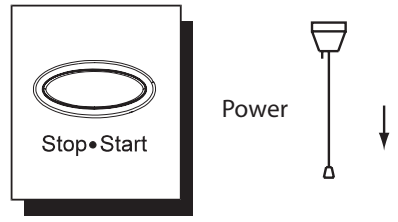

Press **STOP** and isolate power.

17.

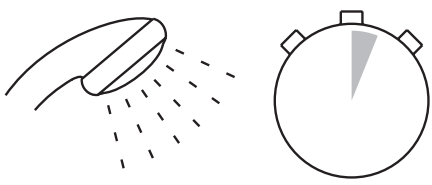

0-5 secs

The shower will purge water from its tank for a few seconds.

18.

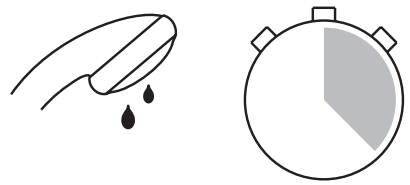

Residual water may drain over a few minutes.

USER INSTRUCTIONS

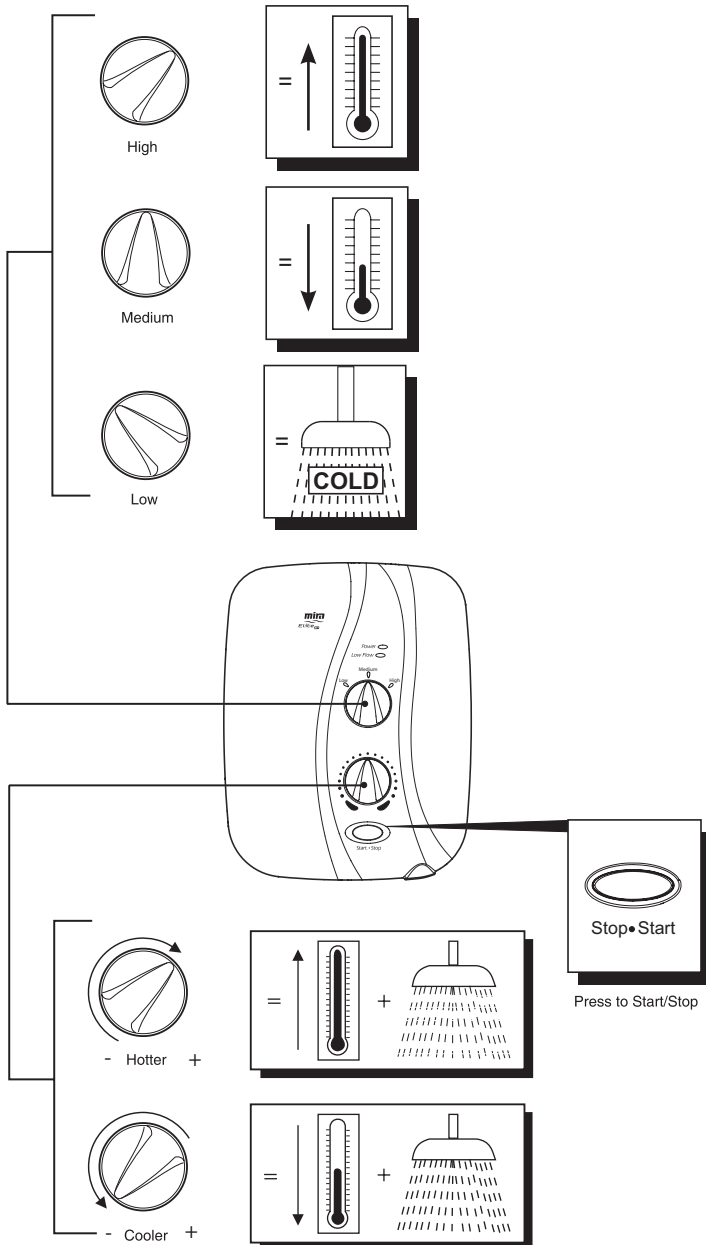

Operation of the Mira Elite ST

Using Your Shower

Read the section 'Important Safety Information' first.

Note! Rapid/Excessive movement of the flow and/or temperature control levers may result in momentary unstable blend temperatures.

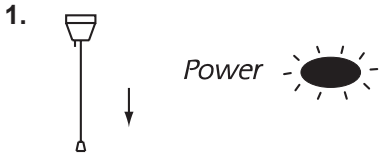

Switch on electrical supply.



Press START button.

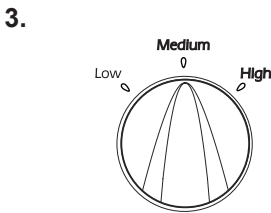

Set to desired position.

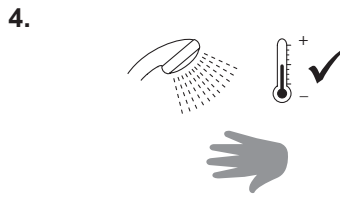

Check water temperature before entering shower.

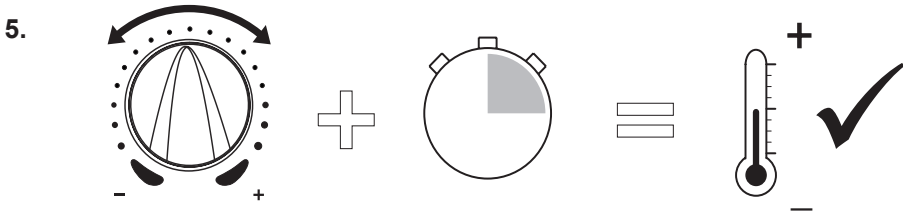

Allow 10-15 seconds for any temperature adjustments to reach the handset. Care is required when adjusting flow or temperature, make sure that the temperature has stabilised.

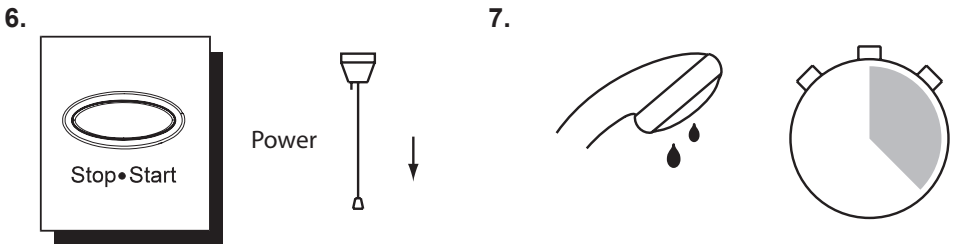

Press STOP button. Shower will continue to run for a few seconds before stopping.

A small amount of water may continue to drain over a few minutes.

FAULT DIAGNOSIS

The trouble shooting information below gives details on probable causes and remedies should difficulties be encountered whilst the shower is in operation.

Warning! There are no user serviceable components beneath the cover of the shower. **Only a competent tradesperson should remove the front cover!**

Symptom	Power Light	Low Flow Light	Heater Setting Low / Med / High	Probable Cause	Possible Remedy
<i>Elite ST fails to operate.</i>	OFF	OFF	Any	Electrical supply isolated at double pole switch.	Switch on electrical supply via pullcord or wall mounted switch.
	OFF	OFF	Any	Fuse blown or MCB/RCD tripped indicating possible electrical fault.	Renew the fuse or reset the MCB/RCD. If fault persists, contact your installer.
<i>No water or very low flow rate.</i>	ON	ON	ANY	Hose or handset sprayplate blocked.	Remove and clean.
	ON	ON	ANY	Incoming water supply isolating valve turned down or off.	Turn isolating valve to fully on position.
<i>Shower cycles from hot to cold.</i>	ON	OFF	MED / HIGH	Temperature knob or heater setting too high.	Turn the TOP knob to MEDIUM setting and re-adjust temperature knob until suitable temperature is achieved.
	ON	ON	MED / HIGH	Handset sprayplate blocked.	Remove and clean.
<i>Unable to select a cool enough temperature.</i>	ON	OFF	HIGH	Due to a rise in the stored water temperature, the power rating may be too high.	Turn the TOP knob to MEDIUM setting and re-adjust temperature knob until suitable temperature is achieved.
	ON	ON	MED / HIGH	Handset sprayplate blocked.	Remove Handset and clean.
<i>No water and motor tone increases.</i>	ON	ON	ANY	Cistern has run out of water.	Turn off the Elite ST immediately and resolve cistern storage difficulty.
	ON	ON	ANY	Internal pump unit faulty or thermal trip has operated.	Wait for internal pump / shower to cool down. If still faulty contact your installer.
<i>Handset dripping.</i>	OFF	OFF	ANY	Flow Valve faulty	Replace
<i>Water will not turn off.</i>	ON	OFF	MED/HIGH	Flow Valve, Solenoid or Start/ Stop switch faulty	Replace parts as required.

All the following remedies must be performed by a competent tradesperson!

Symptom	Power Light	Low Flow Light	Heater Setting Low / Med / High	Probable Cause	Possible Remedy
<i>Low or no flow.</i>	ON	ON	ANY	Filter or water supply pipework restricted by a blockage or partial blockage.	Flush supply pipe. Clean filter.
	ON	ON	ANY	Insufficient water supply pressure / flow for operation.	Gravity fed system, minimum pressure 0.8 kPa (0.008 Bar / 80 mm).
	ON	OFF	ANY	Hose or handset sprayplate blocked.	Remove and clean.
	ON	OFF	ANY	Flow Valve faulty.	Replace.
	ON	OFF	ANY	Heater tank excessively scaled.	Replace. In hard water areas consider the use of a water softener.
	ON	OFF	ANY	Service tunnel or cover not fitted correctly causing Start/ Stop button not to operate.	Check case inserts are cut and fitted correctly. Check services (electrical / plumbing) are not interfering with the location of service tunnel or cover.
	ON	OFF	ANY	Pump faulty.	Replace.
<i>Operation of Temperature Control has little or no effect on water temperature.</i>	ON	ON	MED / HIGH	Hose, handset or Filter blocked.	Remove and clean.
	ON	OFF	MED / HIGH	Flow Valve faulty.	Replace.
	ON	OFF	MED / HIGH	Heater Tank failure.	Replace.
	ON	OFF	MED / HIGH	Microswitch failure.	Replace.
<i>No change in temperature between Low / Med / High settings.</i>	ON	OFF	ANY	Possible Flow Valve, Microswitch or Heater Tank failure.	Check the continuity of the Microswitch or Heater Tank and replace parts as required.
<i>Appliance fails to produce hot water when set on Med / High heater setting.</i>	ON	FF	MED / HIGH	Possible Microswitch or Thermal Switch failure.	Check the continuity of the Microswitch or Heater Tank and replace parts as required.
	ON	OFF	MED / HIGH	Possible Heater Tank failure.	Replace.

MAINTENANCE

Filter - Cleaning/Renewing

Read the section 'Important Safety Information' first.

1.



Electrical supply is turned off at the mains.

2.

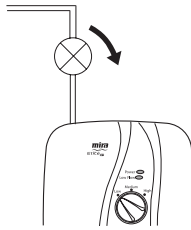

Turn water supply fully off.

3.

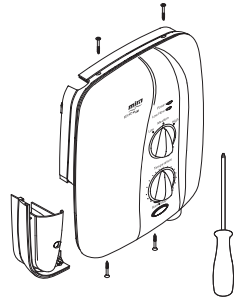

Remove the four screws and the Cover.

4.

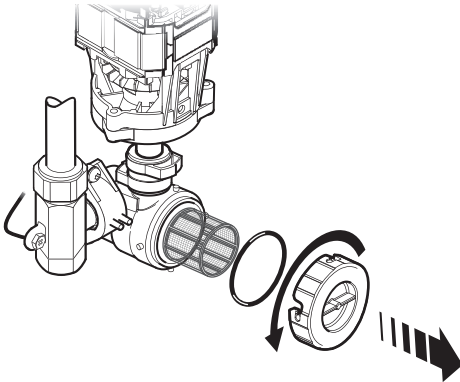

Press down on the filter cover and turn anti-clockwise to release.

Remove the filter cover and filter.

Clean the filter and wipe the inside of the filter housing to remove any debris.

Replace the filter ensuring it is located over the pins in the filter body.

Refit in reverse order, making sure that the O-ring is correctly seated.

Cleaning

Many household cleaners contain abrasives and chemical substances, and should not be used for cleaning plated or plastic fittings. These finishes should be cleaned with a mild washing up detergent or soap solution, and then wiped dry using a soft cloth.

Spray Plate Assembly - External

1. Use your thumb or a soft cloth to wipe any limescale from the soft nozzles and the front surface of the showerhead spray plate.

Important! The Showerhead **must** be de-scaled regularly to make sure that the spray plates do not become blocked.

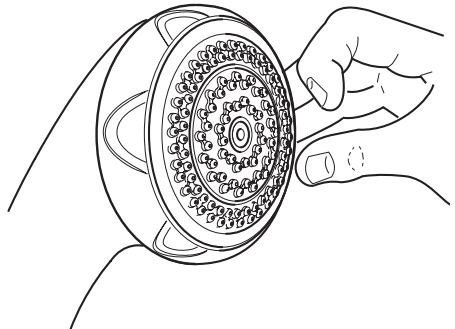

SPARE PARTS

215 12	Thermal Trip Pack
416 38	Clamp Bracket
416 41	Thermal Switch
416 48	Latching Switch
416 51	Solenoid Coil Assembly
428 56	Cover Seal (not shown)
428 59	Service Tunnel (White)
1674 018	Service Tunnel (Satin)
428 61	Transfer/Inlet Tubes
428 62	Motor/Pump Assembly
872 01	Microswitch N/O - 2 pin
872 28	Microswitch C/O - 3 pin
1563 516	Outlet Connector
1563 504	Heater Tank 9.8 kW
1677 210	Heater Tank 10.8 kW (refer to note: ' Important ' below)
1563 748	P/C Flow Valve Assembly 9.8 kW
1563 749	P/C Flow Valve Assembly 10.8 kW (refer to note: ' Important ' below)
1563 509	Switch Assembly
1563 604	Cover Assembly (White)
1674 017	Cover Assembly (Satin)
1563 605	Component Pack - components identified 'A' (White)
1674 019	Component Pack - components identified 'A' (Satin)
1563 606	Terminal Block Assembly
1563 607	Wire Harness Assembly
1563 608	Screw Pack - components identified 'B'
1563 679	Filter Assembly Spare
1563 687	Filter Tube and Seal Pack - components identified 'C'
1563 691	Filter

Important! 10.8 kW flow valves and 10.8 kW heater tanks are **NOT** interchangeable with 9.8 kW models. The fitting of 10.8 kW spares on 9.8 kW models will void the warranty on the product.

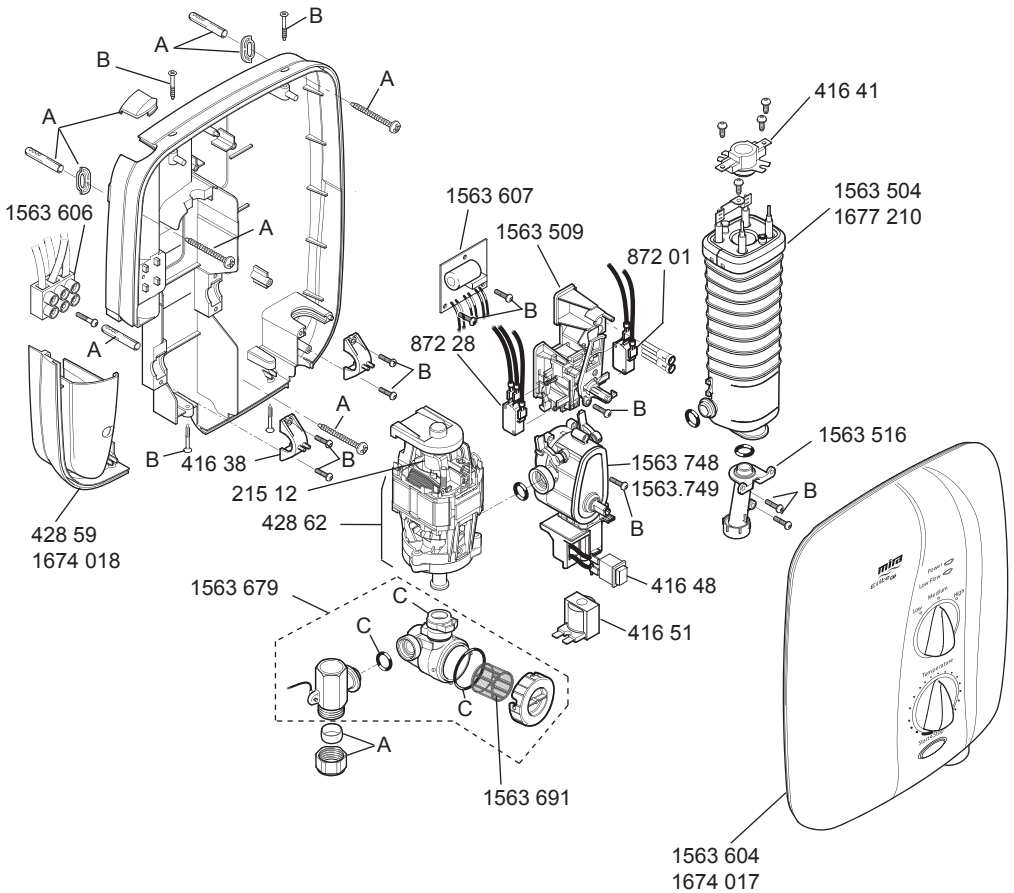

Important Note!

Push-fit connectors must be assembled **back to back** onto the micro-switch terminals.

A minimum air gap of **4 mm** must be maintained between the connectors after assembly.

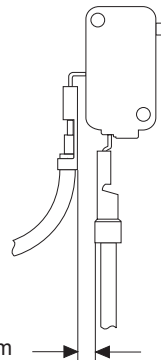

4 mm minimum

CUSTOMER SERVICE

Guarantee

Your product has the benefit of our manufacturer's guarantee which starts from the date of purchase.

To activate this guarantee, please return your completed registration card, visit our website or free phone 0800 0731248 within 30 days of purchase (UK only).

Within the guarantee period we will resolve defects in materials or workmanship, free of charge, by repairing or replacing parts or product as we may choose.

This guarantee is in addition to your statutory rights and is subject to the following conditions:

- The guarantee applies solely to the original installation under normal use and to the original purchaser only. The product must be installed and maintained in accordance with the instructions given in this user guide.
- Servicing must only be undertaken by us or our appointed representative. **Note!** if a service visit is required the product must be fully installed and connected to services.
- Repair under this guarantee does not extend the original expiry date. The guarantee on any replacement parts or product ends at the original expiry date.
- For shower fittings or consumable items we reserve the right to supply replacement parts only.

The guarantee does not cover:

- Call out charges for non product faults (such as damage or performance issues arising from incorrect installation, improper use, inappropriate cleaning, lack of maintenance, build up of limescale, frost damage, corrosion, system debris or blocked filters) or where no fault has been found with the product.
- Water or electrical supply, waste and isolation issues.
- Compensation for loss of use of the product or consequential loss of any kind.
- Damage or defects caused if the product is repaired or modified by persons not authorised by us or our appointed representative.
- Routine maintenance or replacement parts to comply with the requirements of the TMV 2 or TMV 3 healthcare schemes.
- Accidental or wilful damage.
- Products purchased ex-showroom display.

What to do if something goes wrong

If your product does not work correctly refer to this manual for fault diagnosis and check that it is installed and commissioned in accordance with our instructions. If this does not resolve the issue, contact us for help and advice.

Extended Guarantees

A selection of protection plans are available that enable you to cover repair bills (excludes Eire). Ring 01922 471763 for more details.



Helpdesk Service - Ring our Customer Services Team for product advice, to purchase spare parts or accessories or to set up service visit. You can contact us via phone or e-mail, details below. Please provide your model name, power rating (if applicable) and date of purchase.



Mira Showers Website (www.mirashowers.co.uk)

Visit our website to register your guarantee, download user guides, diagnose faults, purchase our full range of accessories and popular spares, or request a service visit.



Spares and Accessories - We hold the largest stocks of genuine Mira spares and accessories. Contact us for a price or visit our website to purchase items from our accessory range and popular spares.



Service/Repairs - No one knows our products better than our nationwide team of Service Technicians. We can carry out service or repair work to your product both during and after the guarantee period. Ask about our fixed price service repairs.

To Contact Us: UK



0844 571 5000



Fax: 01242 282595



E-mail: Visit www.mirashowers.co.uk/contactus



Mira Customer Services Dept, Cromwell Road, Cheltenham, Gloucestershire, GL52 5EP

To Contact Us: Eire Only



01 531 9337



E-mail: CustomerServiceEire@mirashowers.com

Mira is a registered trade mark of Kohler Mira Limited.

The company reserves the right to alter product specifications without notice.

