



Underscore® 6' Bubblemassage™ Whirlpool Bath K-1835-XH2G



Features

- Center drain.
- Variable-speed pump for adjusting hydromassage intensity.
- Integral lumbar support and armrests for comfort.
- Variable-speed blower lets you adjust airjet massage intensity to 18 levels.

Material

- Acrylic

Hydrotherapy

- Automatic purge cycles remove residual water from air channels after use.
- Pump with air switch for whirlpool.
- Single-speed whirlpool offers eight fully adjustable hydro-massage jets for water flow and direction.
- 118-122 BubbleMassage™ airjets.
- Zones of Control™ feature allows you to target airjet massage to back, midsection, or feet.
- Built-in 1500 W heater.
- Lighted keypad control.

Installation

- Drop-in or under-mount.
- Kit required for under-mount installation (sold separately).

Required Accessories

K-7271 Brass Slotted Overflow Bath Drain
K-9698 Flexjet® Whirlpool Trim Kit

or

K-7272 PVC Slotted Overflow Bath Drain

Recommended Accessories

K-1491 Bath/Whirlpool Pillow
K-1601 Bath/Whirlpool Footstop
K-9497 2-1/2" Keypad Trim
K-593 Under-mount Installation Kit
K-24916 Wireless Music Kit



Codes/Standards

ASME A112.19.7/CSA B45.10
CSA B45.5/IAPMO Z124
ASTM E162
ASTM E662
UL 1795
CSA C22.2 No. 218.2
Greenguard UL 2818 - Gold
CARB P2

KOHLER® One-Year Limited Warranty

See website for detailed warranty information.

Available Color/Finishes

Color tiles intended for reference only.

Color	Code	Description
	0	White
	96	Biscuit
	47	Almond
	NY	Dune
	95	Ice™ Grey
	G9	Sandbar
	33	Mexican Sand™
	K4	Cashmere
	58	Thunder™ Grey
	7	Black Black™

USA/Canada: 1-800-4KOHLER (1-800-456-4537)

Kohler Co. reserves the right to make revisions without notice to product specifications.

For the most current Specification Sheet, go to www.kohler.com.

3-18-2017 06:00

THE BOLD LOOK
OF **KOHLER**®

No change in measurement if connected with drain illustrated. (K-7272)

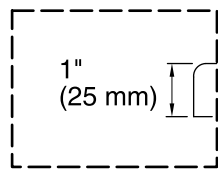

Drop-in Rim Detail

Blower Motor/Control Access
30" (762 mm) W x
15" (381 mm) H

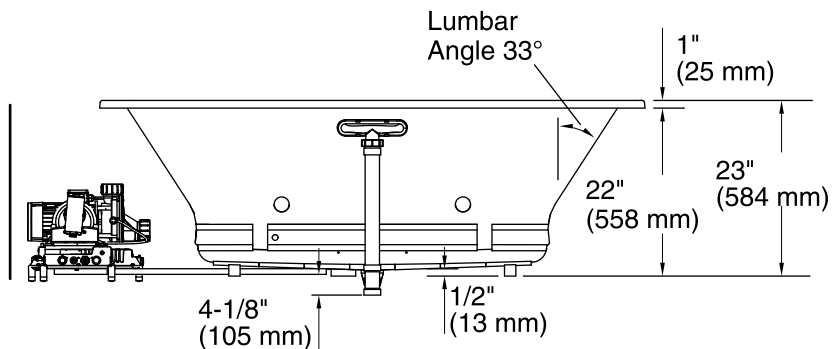
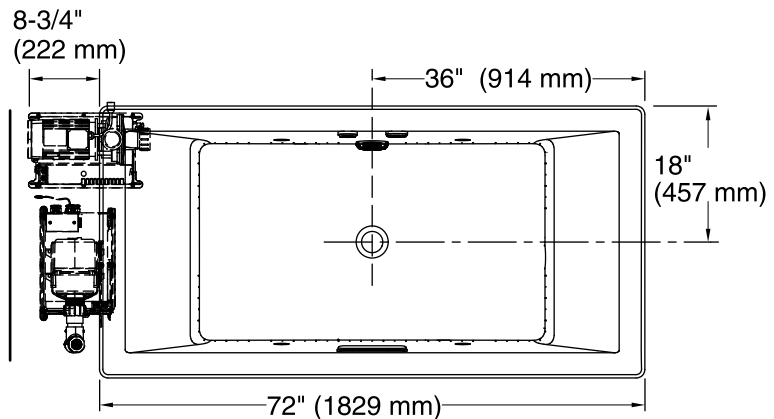
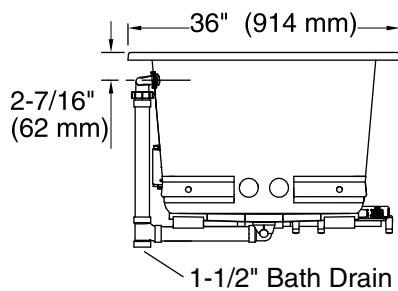

Required Electrical Service

One dedicated circuit required, protected with Class A Ground-Fault Circuit-Interrupter (GFCI) or Residual Current Device (RCD).

Blower, Pump, 220-240 V, 20 A, 50/60 Hz
Heater:

Technical Information

All product dimensions are nominal.

Installation:	Drop-in, Under-mount
Drain location:	Center
Basin area, bottom:	45-3/4" x 25-15/16" (1162 mm x 659 mm)
Basin area, top:	65-3/8" x 29-5/16" (1661 mm x 745 mm)
Weight:	195 lbs (88.5 kg)
Minimum floor load:	62.5 lbs/ft ² (305.2 kg/m ²)
Water depth:	19-7/16" (494 mm)
Water capacity:	112.9 gal (427.4 L)
Cutout:	Drop-in/Top-mount (Bathing), 71-1/2" x 35-1/2" (1816 mm x 902 mm)
Electrical component rating:	Blower: 220-240 V, 5 A, 50/60 Hz, 300 W Pump: 220-240 V, 11 A, 50/60 Hz Heater: 220-240 V, 50/60 Hz, 1500 W

Notes

Measure your actual product for rough-in details.

Install this product according to the installation instructions.

The hot water supply should be 70% of the capacity of the bath or greater. Installations will vary.

IMPORTANT! Dry fit the drain assembly prior to installing the bath. The bath cannot be installed with all drain components attached.

The pump base extends 8-3/4" (222 mm) beyond the edge of the rim. Modify the framing as needed.

For under-mount installations, kit K-593 is available to order.