



### Features

- Center drain.
- Integral lumbar support and armrests for comfort.

### Hydrotherapy

- 120 BubbleMassage™ airjets.
- Zones of Control feature allows you to target massage to back, midsection, or feet.
- Automatic purge cycles remove residual water from air channels after use.
- Built-in 300 W heater.
- Lighted keypad control.

### Installation

- Drop-in

### Recommended Accessories

- K-11677 Bath Drain
- K-1491 Bath/Whirlpool Pillow
- K-1446 Remote Installation Kit
- K-1601 Bath/Whirlpool Footstop
- K-7259 Clearflo Bath Drain
- K-9497 2-1/2" Keypad Trim
- K-37382 45" Rough-in Cable Bath Drain



### Codes/Standards



- ASME A112.19.7/CSA B45.10
- CSA B45.5/IAPMO Z124
- ASTM E162
- ASTM E662
- UL 1795
- Greenguard UL 2818 - Gold
- CARB P2

### KOHLER® One-Year Limited Warranty

See website for detailed warranty information.

### Available Color/Finishes

*Color tiles intended for reference only.*

Color	Code	Description
	0	White
	96	Biscuit
	47	Almond

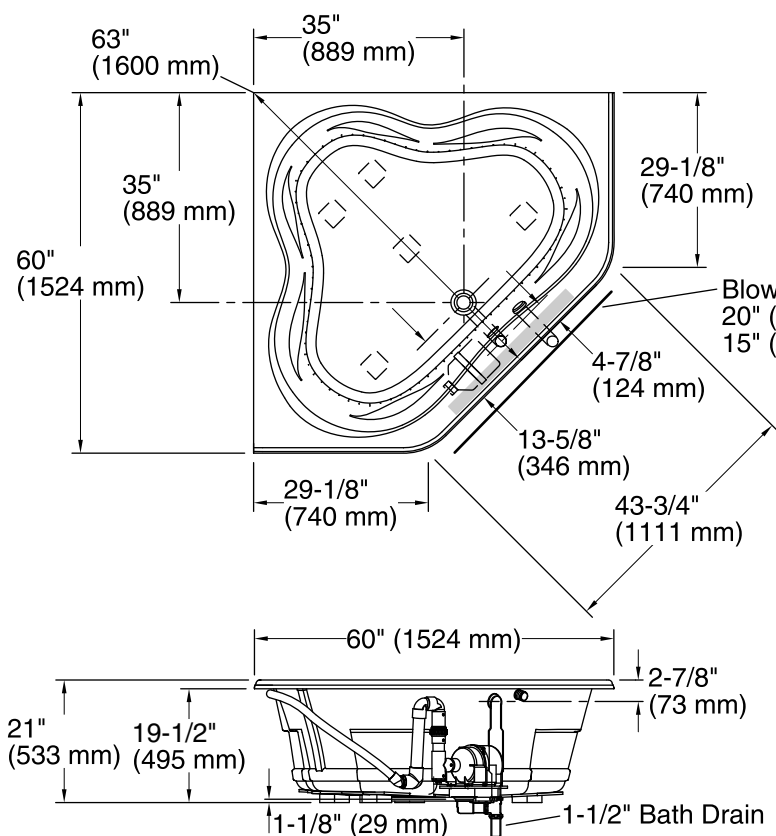

No change in measurements if connected with drain illustrated. (K-11677)

Recommended faucet area

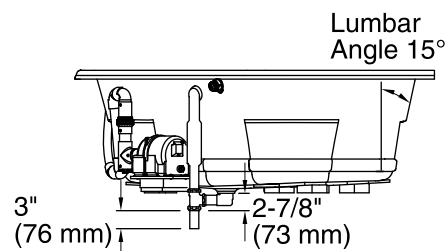
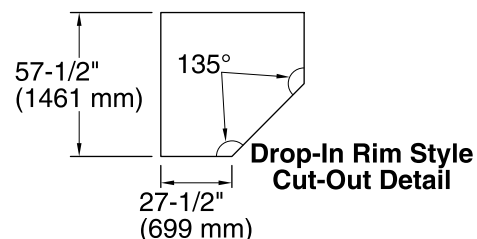
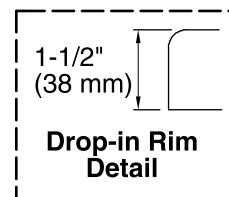

### Required Electrical Service

One dedicated circuit required, protected with Class A Ground-Fault Circuit-Interrupter (GFCI) or Residual Current Device (RCD).

Blower: 120 V, 15 A, 60 Hz

### Technical Information

All product dimensions are nominal.

Installation:	Drop-in
Drain location:	Center
Basin area, bottom:	52" x 38-3/4" (1321 mm x 984 mm)
Basin area, top:	61" x 46-1/4" (1549 mm x 1175 mm)
Weight:	127 lbs (57.6 kg)
Minimum floor load:	39 lbs/ft <sup>2</sup> (190.4 kg/m <sup>2</sup> )
Water depth:	15" (381 mm)
Water capacity:	96 gal (363.4 L)
Electrical component rating:	Blower: 120 V, 10 A, 60 Hz, 300 W

### Notes

Measure your actual product for rough-in details.

Install this product according to the installation instructions.

The hot water supply should be 70% of the capacity of the bath or greater. Installations will vary.

Provide one grounded electrical outlet within 24" (610 mm) of each component.

Remote blower installation kit is available for relocating the blower. Provide access for servicing the blower.

Do not relocate or alter the PVC tee or coiled flexible tubing connected to the blower. Follow the blower relocation instructions exactly.