

ROUGH-IN DIMENSIONS

18009-4

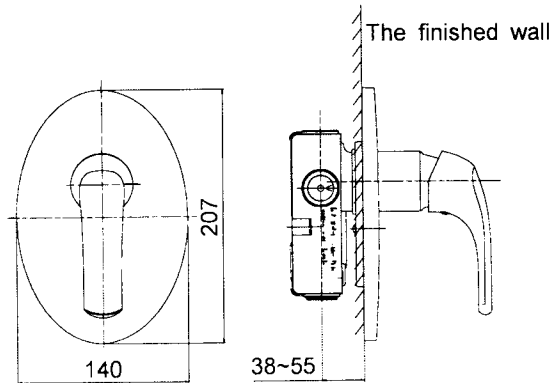

18019-4

