

Features

- Includes face plate with handle.
- Single handle controls flow to outlets.
- Supplied with ADA compliant metal cross handle.
- When used with K-728 Series MasterShower diverter valves, handle controls flow to two or three outlets individually or any two outlets at a time.
- When used with K-737 Series MasterShower diverter valves, handle controls flow to two or three outlets individually (only one outlet at a time).
- Valve (not supplied) can be configured on site for two or three outlet operation.
- 360 degree handle rotation with three outlet operation.
- 120 degree handle rotation with two outlet operation.
- Complements the Purist® faucet and accessory collections.

Material

- Premium material construction with metal handle ensures reliability and durability.
- KOHLER finishes resist corrosion and tarnishing, exceeding industry durability standards.

Installation

- Trim set requires valve to complete installation.
- Patented K-joint installation technology ensures consistent trim appearance, regardless of variability in valve rough-in.

Required Accessories

K-728-K 3/4" Two- or Three-Way Transfer Valve

or

K-737-K 3/4" Two- or Three-Way Diverter Valve



ADA

Codes/Standards

ASME A112.18.1/CSA B125.1

ADA







ICC/ANSI A117.1

KOHLER® Faucet Lifetime Limited Warranty

See website for detailed warranty information.

Available Color/Finishes

Color tiles intended for reference only.

Color	Code	Description
	CP	Polished Chrome
	SN	Vibrant® Polished Nickel
	BGD	Vibrant® Moderne Brushed Gold
	BN	Vibrant® Brushed Nickel
	BV	Vibrant® Brushed Bronze
	BL	Matte Black

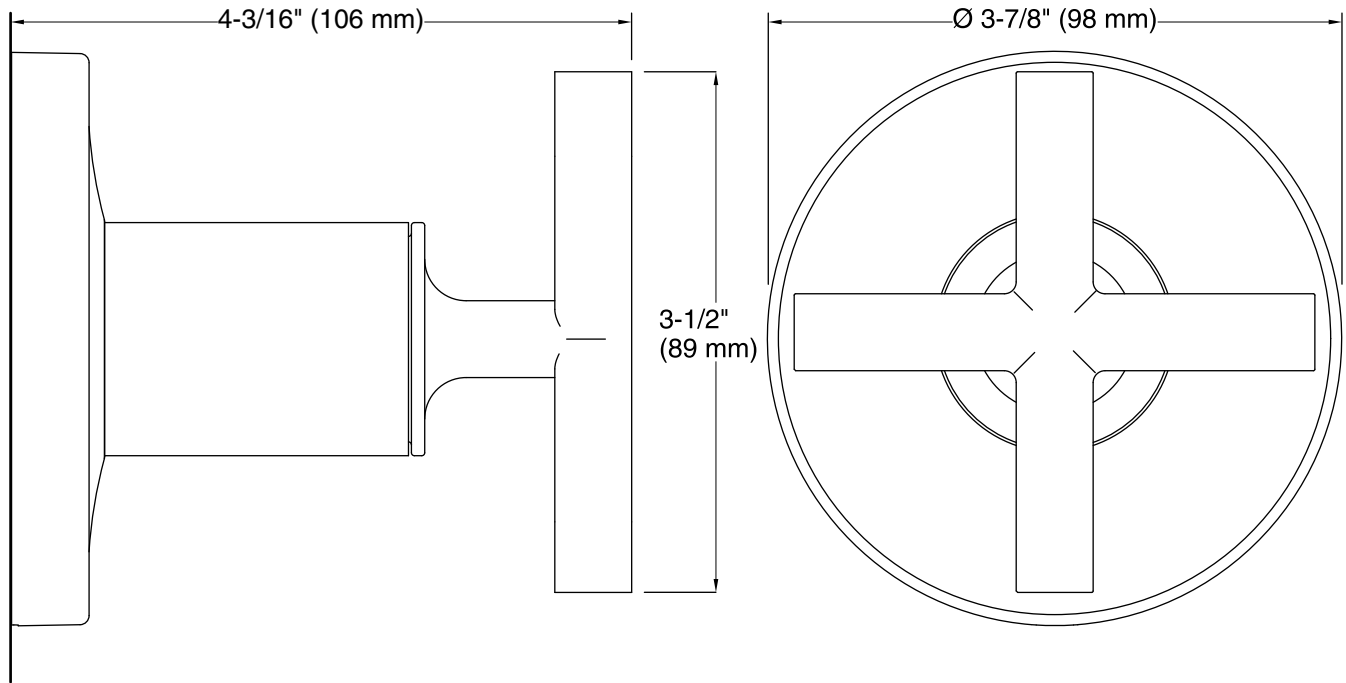

Technical Information

All product dimensions are nominal.

Notes

Install this product according to the installation instructions.

ADA compliant when installed to the specific requirements of these regulations.