

www.kohler.com

R52mm

KOHLER

K-P35108T-S MARCATO 墨珂特

S SGL UC SINK, S, 5P
小单槽台下厨盆(400mm), 5P
CUT-OUT TEMPLATE / INSTALLATION INSTRUCTIONS
切割图/安装说明书

BEFORE YOU BEGIN

- ⚠ WARNING: Risk of personal injury. Metal surfaces are sharp and can cause severe cuts. Use gloves and handle sink edges carefully.**
- Read the installation instructions before using the product.
 - Observe all local plumbing and building codes.
 - Shut off the hot and cold water supplies.
 - Prior to installation, unpack the new sink and inspect it for damage. Return the sink to its protective carton until you are ready to install it.
 - Inspect the drain and supply tubing. Replace if necessary.
 - All information in these instructions is based on the latest product information available at the time of publication. Kohler china. reserves the right to make changes at any time without notice.
 - This product complies with Q/KLCW 1.

RECOMMENDED TOOLS AND MATERIALS

- Safety Glasses
- Measuring Tape
- Pencil
- Drill
- Putty Knife
- Silicone Sealant
- Pipe Wrench
- Plumbers Putty

- Plus:**
- Level
 - Cross Screwdriver
 - Keyhole/Jigsaw
 - Gloves

ROUGHING-IN

Reference Value
参考值
T=0.8/1.0
厚度: 0.8/1.0

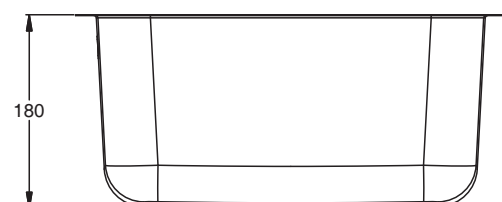
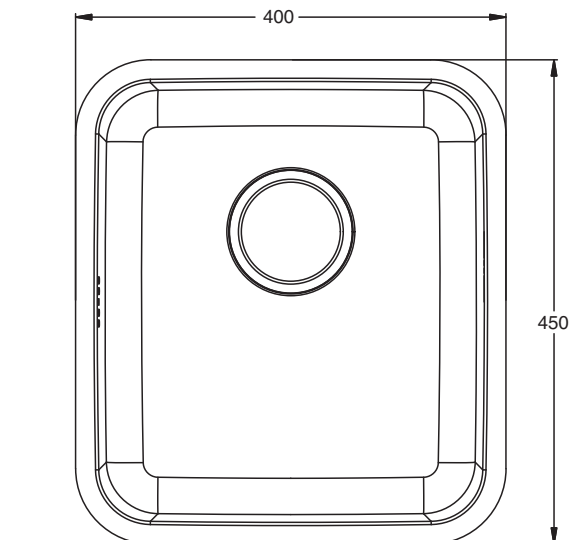

Kohler reserves the right to change marked dimensions without prior notice.
科勒公司保留随时变更图中标示尺寸的权利, 无需另行通知。

安装之前

- ⚠ 警告: 小心人身伤害。金属表面非常锋利, 可能导致严重的划伤。请使用手套, 并小心接触水槽边缘。**
- 使用产品前请阅读使用说明书。
 - 遵循当地所有的管道和建筑规范。
 - 关闭冷热水供应。
 - 在安装之前, 请打开新水槽的包装, 检查产品是否有损坏。将水槽放回其保护性的纸箱包装, 直到您准备安装。
 - 检查供水和排水管道, 如果需要, 请更换管道。
 - 此手册中的所有资料按照出版时的最新产品资料编写。科勒公司保留在任何时候不需通知便可进行更改的权利。

推荐使用的工具和材料

- 安全眼镜
- 测量尺
- 铅笔
- 钻孔机
- 灰泥刀
- 硅胶
- 管道扳手
- 管道用灰泥

- 其它:**
- 水平尺
 - 十字螺丝刀
 - 锁眼锯或锯齿锯
 - 手套

尺寸图

单位: 毫米
Unit: mm

INSTALL THE NEW SINK

1. Preparation

⚠ WARNING: Risk of personal injury. Metal surfaces are sharp and can cause severe cuts. Use gloves and handle sink edges Carefully.

- For new installations:**
- Cut out the cut-out template along the marked line.
 - Carefully place the cutout template on the countertop in the desired position.
 - Locate the faucet hole center lines on the countertop. The faucet hole clearance from the top of the cutout must be 2-3/8" (6cm) minimum.

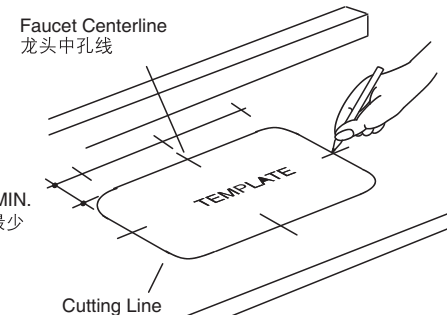

- Make sure the sink will not interfere with the cabinet.
- Trace the cutout template outline onto the countertop.
- Drill a pilot hole inside the cutting line. Using a jig or keyhole saw, cut along the outline to cut out the opening in the Countertop.

- For existing installations:**
- Carefully lift the old sink out of the countertop.
 - Compare the existing cut-out to the required cut-out size.
 - If needed, enlarge the cut-out hole according to the directions for new installations.

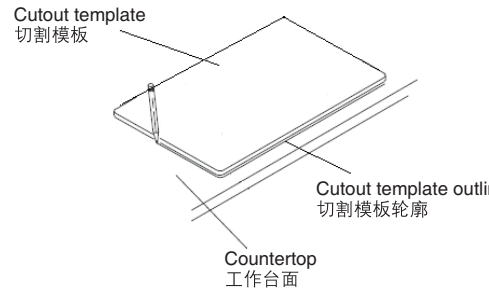

Trace the outline of the cutout template on the countertop with a pencil at the desired installation location. 用铅笔在厨房工作台上您希望安装水槽的位置画下切割模板的轮廓。

安装新水槽

1. 准备安装

⚠ 警告: 小心人身伤害。金属表面非常锋利, 可能导致严重的划伤。请使用手套, 并小心接触水槽边缘。

- 对于新安装:**
- 沿着标注的“沿此线切割”剪出切割模板。
 - 细心地将切割模板放在厨房工作台上您希望安装水槽的位置。
 - 在橱柜台面上找到龙头中孔线。龙头孔和切割模板顶部的距离至少需为2-3/8" (6cm)。

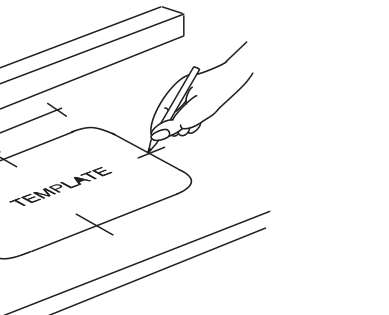

- 确保水槽不会和橱柜互相干扰。
- 请在工作台上画下切割模板的轮廓。
- 在切割线内部钻一个导向孔。使用锯齿锯或锁眼锯, 沿着轮廓线进行切割。在工作台上切割出水槽安装孔。

- 对现有水槽更换, 进行新水槽安装:**
- 细心地将旧水槽取出厨房工作台面。
 - 比较现有的切割出来的水槽安装面积的大小和新水槽所要求的面积大小。
 - 如果需要, 根据安装指南扩大切割孔。

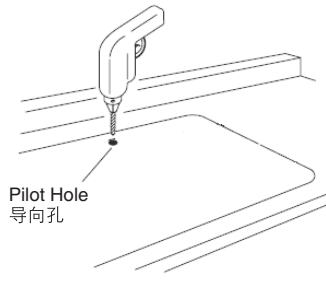

Cut along the outline to cut out the opening in the countertop 沿着画出的轮廓线切出水槽安装孔。

WHEN PLOTTING TEMPLATE FULL SIZE: Make sure horizontal and vertical dimensions match the dimensions labeled on the template.

当在台面上一比一描绘切割线时, 务必确保模板的水平 and 垂直尺寸与模板上标注的一致。

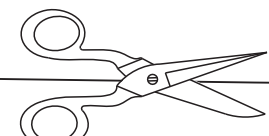

CUT ALONG THIS LINE
沿此线切割

RIM OF SINK
水槽边缘

2. Install the Faucet Fitting and Drain

- Install the faucet overflow pipe and strainer according to the manufacturer's instructions.

NOTE: If you are reusing fittings from an old sink, use plumbers putty under the faucet base and top flange of the strainer.

3. Install the Mounting Brackets

- For laminate type countertops, make sure that all exposed non-laminated surfaces located near the cut-out area are finished and sealed to prevent damage from water absorption.
- Equally space the required number of mounting brackets (see chart on roughing-in page) and locate the mounting holes on the underside of the countertop 35mm from the edge of the countertop opening.
- The type of fastener needed is depended on the countertop material and should be recommended by the countertop supplier.
- Loosely install the mounting brackets to the countertop.
- Turn the brackets parallel to the opening to allow for easy installation of the sink.

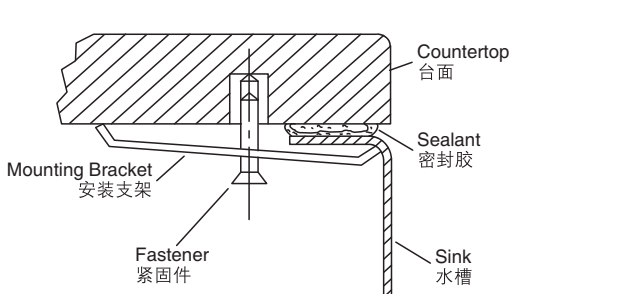
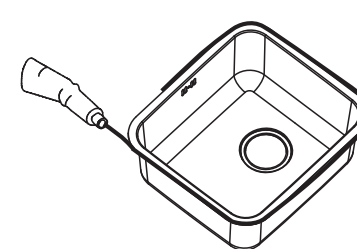
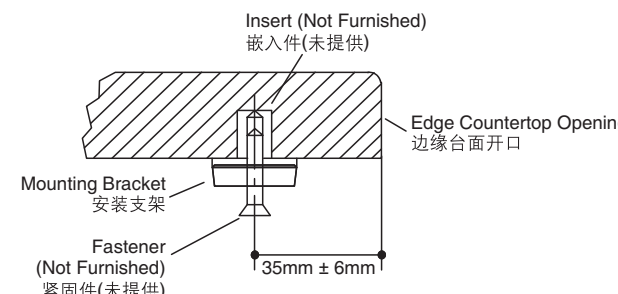

4. Apply the Sealant

- Clean all residue from the top rim of the sink.
- Clean the underside of the countertop around the cut-out area and make sure the surface is smooth and free of defects.
- Apply a generous bead of silicone or latex sealant to the rim of the sink near the inside edge.

5. Finish the Installation

- Position and align the sink with the opening in the countertop. The corner of the sink should be flush with the inside edge of the countertop.
- Turn the mounting brackets to the sink rim side.
- Tighten each bracket until snug while maintaining proper alignment.
- Wipe away any excess sealant with a dry cloth.
- Verify that there are no gaps.
- Allow the sealant to cure for a minimum of 30 minutes. Follow the instructions provided with the sealant.

6. Connect Water Supply and Test

- Install the garbage disposal, if used, according to the manufacturer's instructions.
- Connect and tighten the trap to the strainer and complete the water supply connections to the faucet according to the instructions packed with the faucet.
- Run water into the sink and check for leaks.

Note

If you are inconvenienced with the above installation, you can use other reliable ways which are according to countertop material and recommendations from installation engineer. Kohler would not provide other recommendations and won't be responsible for it.

2. 安装龙头和排水装置

- 根据生产商的指示安装龙头溢水管和下水器。

注意: 如果您采用旧水槽的有关装置, 在龙头底部基础部位和下水器的顶部法兰处使用管道密封胶。

3. 安装支架

- 对于层压板台面, 请确保位于切口区域附近的所有裸露的非层压表面都已处理并密封, 以防止因受潮吸水而损坏。
- 将所需数量的安装支架 (参见加工页面上的图表) 相等地间隔安装在台面底部。安装孔定位在距台面开口边缘 35mm 处。
- 所需的紧固件类型取决于台面材料, 应由台面供应商推荐。
- 将支架松散地安装到台面底部。
- 支架平行并正对于开口, 以便于安装水槽。

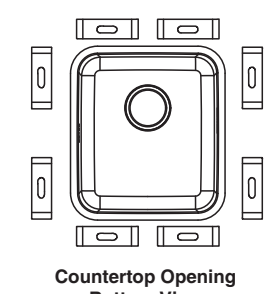

1. Drill a hole at the bottom, then put the nut into the hole. 在底部钻一个孔, 然后将螺母放进孔里。

2. Fasten sink with screw. 用螺丝固定水槽。

3. Install upper panel. 安装上盖板。

4. 涂抹密封胶

- 清洁水槽顶部边缘的所有残留物。
- 清洁台面的底部切口周围区域, 以确保表面光滑无破损。

- 将大量硅胶或乳胶密封胶涂在水槽边缘靠近开口内边缘处。

5. 完成安装

- 将水槽与台面上的开口对齐。水槽的角落应与台面的内边缘齐平。
- 将安装支架旋转到水槽边缘上。
- 拧紧每个支架直到压紧并保持对齐。
- 用干布擦去任何多余的密封胶。
- 检查没有间隙。
- 至少30分钟让密封胶固化且按照密封胶随附的说明进行操作。

6. 连接供水和测试

- 如需使用垃圾处理器, 请根据制造商提供的说明指导安装。
- 将疏水网连接并拧紧到过滤器上, 并按照水龙头说明完成与水龙头的供水连接。
- 放水流入水槽并检查是否有渗漏。

注意

如果您对上述安装感到不便, 您可以根据台面材料和安装工程师的建议使用其他可靠的安装方法。科勒不会提供其他建议, 并不对此负责。

CARE AND CLEANING

Stainless Steel

Rinse your stainless steel sink thoroughly after each use, and use a dabbling action to dry with a clean, soft cloth. Clean stainless steel once a week.

Always apply stainless steel cleaner/polish with a nonabrasive cloth or sponge, working with, not across the grain. Do not use steel wool, wire brushes or abrasive pads to clean your sink.

If you use cleaners containing chlorides, be sure to rinse the surface immediately after you clean it to avoid corrosion. Do not allow cleaners to remain in contact with the sink surface for long periods of time.

Kohler kitchen sink accessories, including bottom basin racks, wire rinse baskets, cutting boards and colanders will help protect the surface of your sink.

If the surface becomes excessively dirty, consider using baking soda, or a general purpose cleaner.

⚠ Do not use wet cloth, water or other liquid to clean the undercoating on the back of the sink.

保养和清洁指南

不锈钢

每次使用后, 请彻底冲洗您的不锈钢水槽, 并使用清洁的软布将其擦干。对于不锈钢用品, 请每周清洗一次。

请使用非磨蚀性的布或海绵, 并用不锈钢专用清洁剂/光亮剂进行清洗, 而不要使用带颗粒的清洁剂。请不要使用钢丝球、钢丝刷或者磨蚀性的抹布清洗不锈钢水槽。

如果您使用了含有氯化物的清洁剂, 在您清洗水槽之后, 请立即对水槽表面进行冲洗, 以防止腐蚀。不要让清洁剂在您水槽表面停留过长时间。

科勒厨房水槽附件, 包括底部盆架、金属丝冲洗篮、砧板和沥水篮均有有助于保护您的水槽表面。

如果水槽表面很脏, 使用碳酸氢钠, 或普通的清洁剂进行清洗。

⚠ 不要用湿布、水或其他液体清洁水槽背面的底涂层。

1520372-T2-A

ZHUHAI KOHLER KITCHEN & BATHROOM PRODUCTS CO., LTD NO.15, XIN QING LIU ROAD, JING AN TOWN, DOU MEN DISTRICT, ZHUHAI, PRC POST CODE: 519180
珠海科勒厨卫产品有限公司 珠海市斗门区井岸镇新青六路15号 邮编: 519180

© Copyright Kohler China Investment Co., Ltd. 2022
© 版权为科勒(中国)投资有限公司所有 2022