

Features

- Above-counter.
- Rectangular basin.
- Without overflow.
- No faucet holes; requires wall- or counter-mount faucet.
- 18-1/4" (464 mm) x 15-5/8" (397 mm)

Material

- KOHLER® enameled cast iron.

Recommended Accessories

K-7124 Pop-Up Clicker Drain
K-7129 Drain
K-9018 P-Trap



ADA

Codes/Standards















ASME A112.19.1/CSA B45.2
ADA
ICC/ANSI A117.1

Lifetime Limited Warranty for KOHLER® Cast Iron Components

See website for detailed warranty information.

Available Color/Finishes

Color tiles intended for reference only.

Color	Code	Description
	0	White
	FF	Sea Salt™
	96	Biscuit
	47	Almond
	FD	Cane Sugar™
	NY	Dune
	95	Ice™ Grey
	G9	Sandbar
	33	Mexican Sand™
	KC	Vapour™ Blue
	K4	Cashmere
	FT	Basalt
	58	Thunder™ Grey
	KA	Black 'n Tan
	7	Black Black™

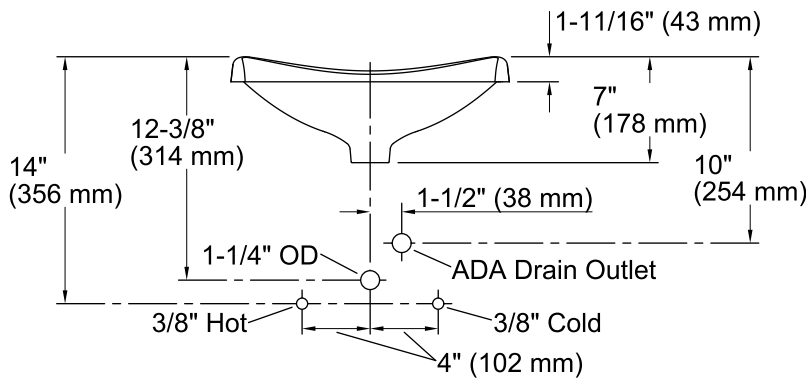
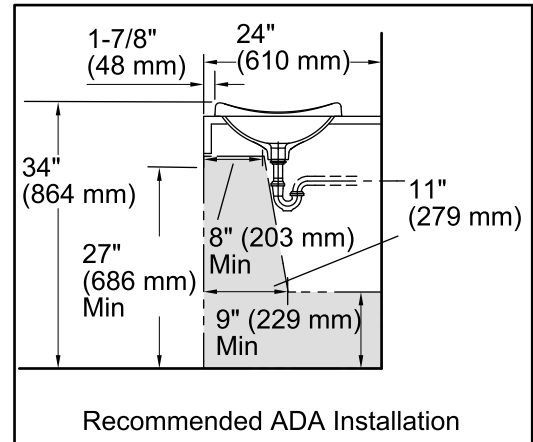
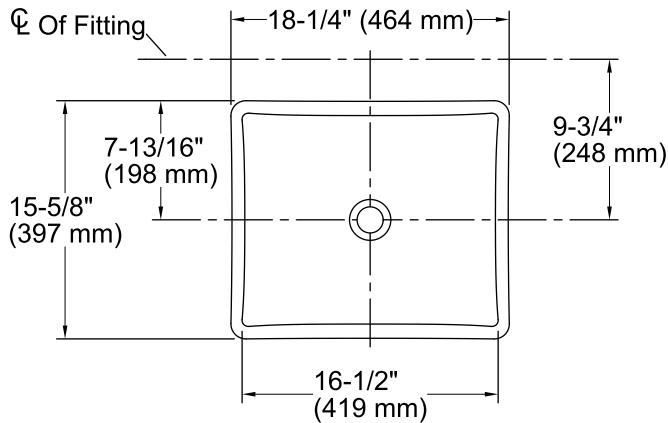

Technical Information

All product dimensions are nominal.

Bowl configuration:	Single
Installation:	Vessel
Bowl area (Only):	Length: 16-1/2" (419 mm) Width: 13-3/4" (349 mm) Water depth: 5" (127 mm)
Drain hole:	1-3/4" (44 mm)
Template:	1046630-7, required, included

Notes

Install this product according to the installation instructions.

Product does not have overflow.

NOTICE: Countertop manufacturer or cutter must use the cut-out template provided with the product, or a current one provided by Kohler Co. (call 1-800-4KOHLER). Kohler Co. is not responsible for cutout errors when the incorrect cut-out template is used.

The spout must be a minimum of 5" (127 mm) long for adequate clearance into the bathroom sink when installed with the centerline, as shown.

ADA compliant when installed to the specific requirements of these regulations.