

8632T 72673T 挂墙式浴缸花洒龙头
8633T 72674T 挂墙式花洒龙头

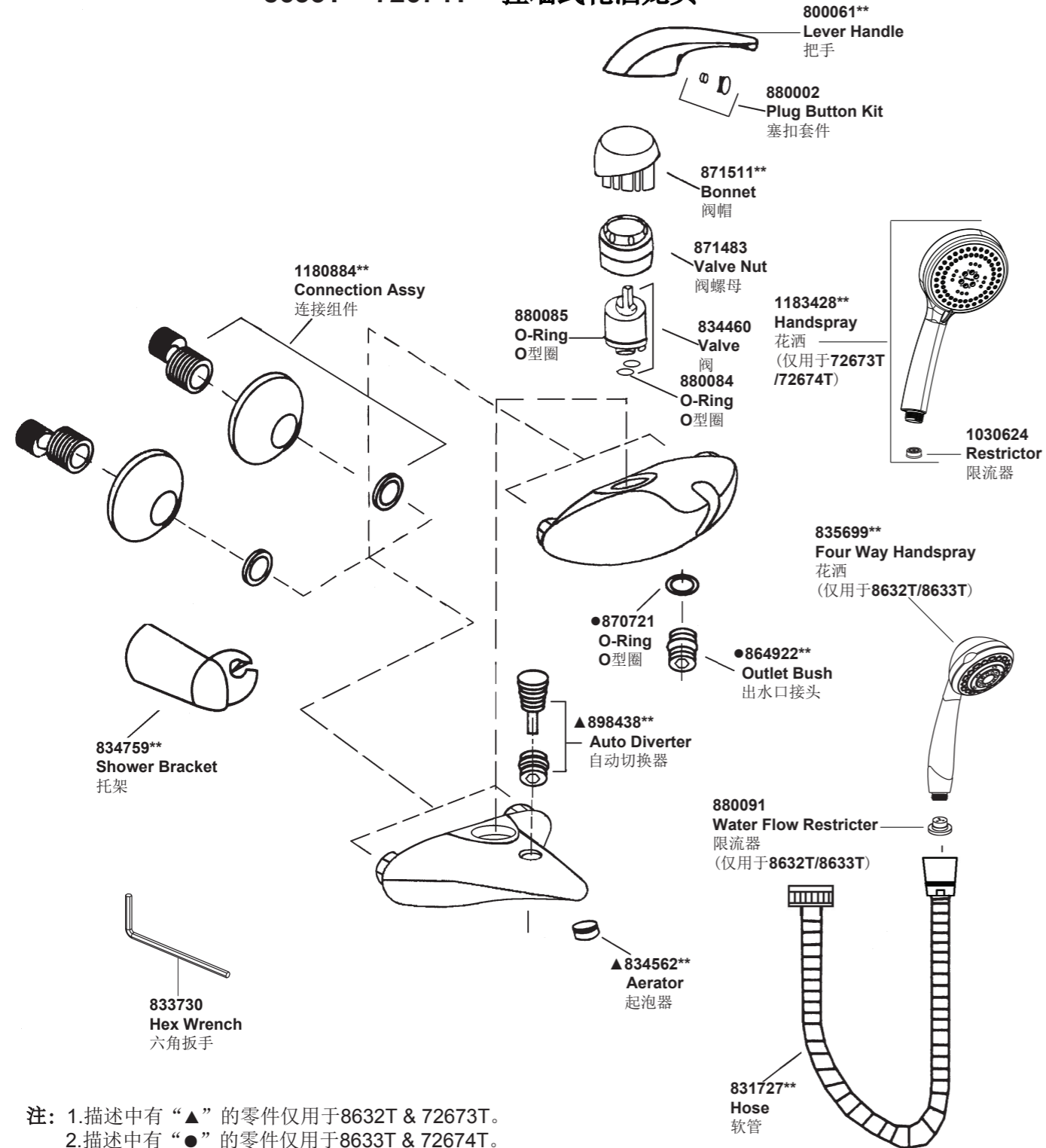

注：1.描述中有“▲”的零件仅用于8632T & 72673T。
2.描述中有“●”的零件仅用于8633T & 72674T。

**订购时请说明颜色编号
**Color code must be specified when ordering

8632T 72673T 挂墙式浴缸花洒龙头
8633T 72674T 挂墙式花洒龙头

安装之前

所有的资料是按最新出版的产品资料编写而成。科勒公司保留任何时候不经通知即可改变产品特性、包装或产品可供类型的权利。

说明书包括重要的安装、保养及清洁方面的内容，请把这些资料交给用户阅读。

注意事项：

1. 一定要先彻底冲洗供水管以清除管道中的杂质。
2. 切换器正常工作的最小压力为0.05MPa(0.5bar)。
3. 花洒最高工作压力：0.5MPa(5bar)。水压超过0.5MPa(5bar)须安装减压阀。花洒最高工作温度及环境温度：60°C。请特别注意花洒同花洒连接的臂管须远离浴霸，否则可能损坏花洒及其密封件，甚至对使用者造成伤害。

BEFORE YOU BEGIN

All information is based on the latest product information available at the time of publication. Kohler Co. reserves the right to make changes in product characteristics, packaging, or availability at any time without notice. Please leave these instructions for the consumer. They contain important information.

NOTES:

1. Flush the water supply pipes thoroughly to remove debris.
2. The minimum inlet water pressure for the diverter is 0.05MPa(0.5bar).
3. The highest working pressure for handspray is 0.5MPa(5bar). If it exceeds 0.5MPa(5 bar), a pressure reducer is needed. The highest water and environment temperature is 60°C. Please keep handspray, showerhead and the shower arm away from heater, or it may become damaged and cause injury to the user.

安装尺寸

ROUGH-IN DIMENSIONS

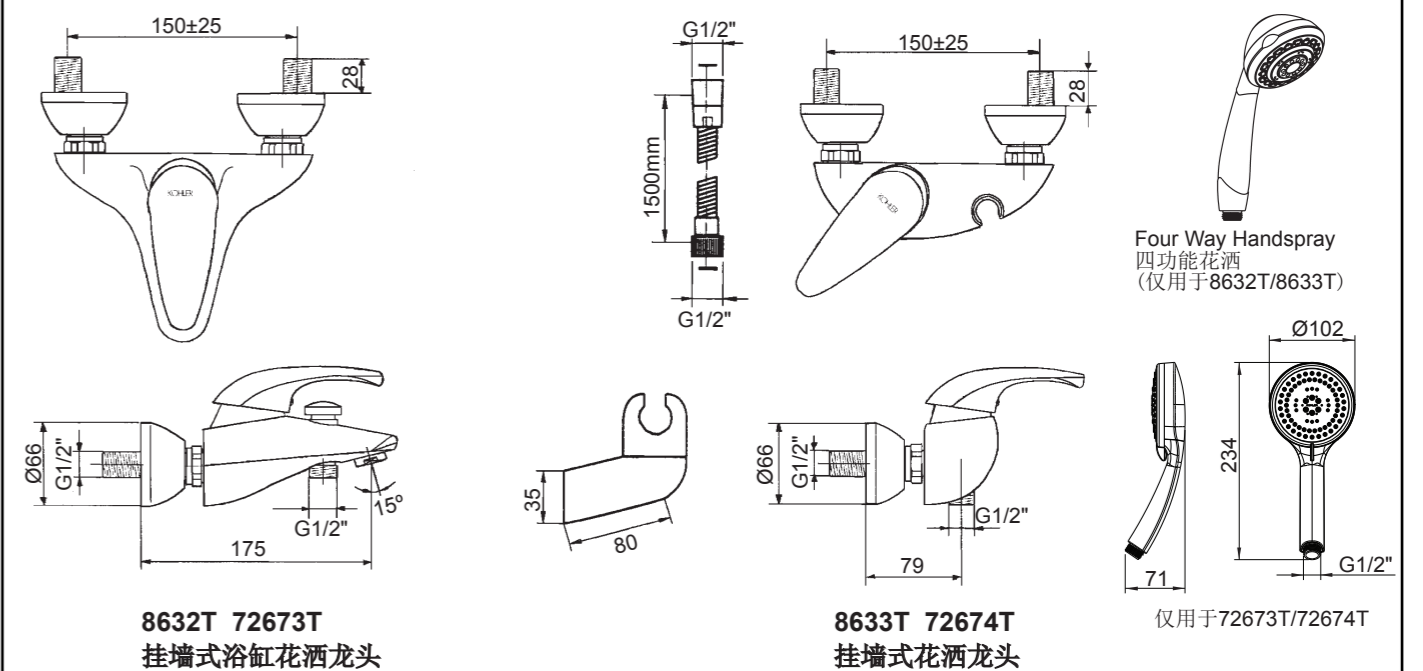

安装说明

如何安装水龙头

为使安装顺利，G1/2"内螺纹管道配件(1)应已装好，预留150mm的间距，保持水平，不要凸出墙面。

彻底冲洗供水管，以清除管路中的杂质。

使用合适的螺纹密封膏，安装两个接头(3)到冷热供水管(2)。

保持两个接头中心到中心的距离150mm，并调整到同一水平线上。

把装饰罩(4)旋入接头，紧贴墙壁。

把密封垫片(9)放入水龙头螺母(8)内。

把螺母拧在接头上，并旋紧。

垫圈应安装在淋浴软管(6)的两头。把淋浴软管一头接到水龙头出口(7)，另一头接花洒(5)。

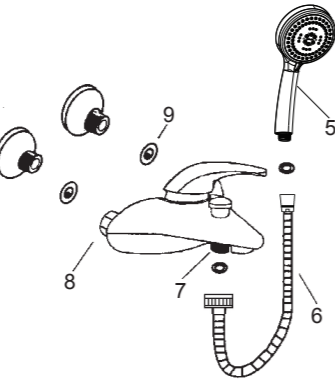
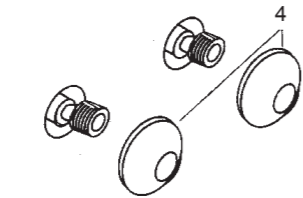
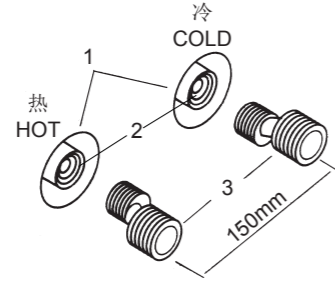

INSTALLATION

How To Install The Faucet

To perform installation, installer must provide G1/2" female supply fittings(1), spaced 150mm apart, level and not extending beyond finished wall surface.

Flush the water supply pipes thoroughly to remove debris.

Install the two offset connectors(3) into the hot and cold supply pipes(2). Use appropriate thread sealants on pipe threads.

Adjust the center-to-center distance between the connectors to 150mm and level.

Thread the trim caps(4) onto the connectors so that the trim cap contacts the finished wall.

Insert washer seals(9) into supply nuts (8) of the faucet.

Thread the faucet supply nuts onto the connectors and tighten them.

Connect shower hose(6) to faucet shower outlet(7) and handspray(5). Seals provided with hose must be installed in each end.

如何安装托架

在垂直的墙壁上，选一合适的高度，来安装托架。

把托架盖子(11)与底板(10)撬开。

在墙壁上标上安装孔(12)位置的记号，如图所示。

在墙上钻两个洞，以便于安装螺钉及铰钉。

旋紧螺钉，使托架固定紧贴墙壁。

用托架盖子盖住底板。

把花洒挂到托架上。

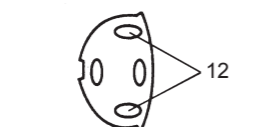
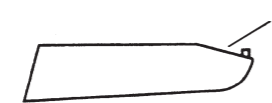
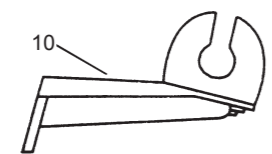

How To Install The Bracket

Select a location on the vertical wall within reach of the shower hose.

Pry between the bracket cover(11) and base(10) to separate the two parts.

Mark bracket base mounting hole(12) locations on wall as shown.

Drill two holes in the finished wall as required, for the installation screws and anchors.

Tighten screws to secure bracket base to the finished wall.

Replace bracket cover onto bracket base .

Hang the handspray on the shower bracket.

安装结果检查

确定所有联接螺母都已锁紧。确定手柄在关闭的位置。

开启主水源，检查是否有漏水。如有漏水，修理之。

浴缸/淋浴龙头:

取下起泡器组件(13)和花洒(5)。把冷热水都打开，让水流出约一分钟以清除杂质。检查渗漏。清洗起泡器。关闭水龙头，装回起泡器组件和花洒。

淋浴龙头:

取下花洒(5)。把冷热水都打开，让水流出约一分钟以清除杂质。检查有无渗漏。关闭水龙头，并装回花洒。

淋浴时根据高度的不同需要，可将花洒插在托架上，也可将其插在本体的花洒插孔(14)中。

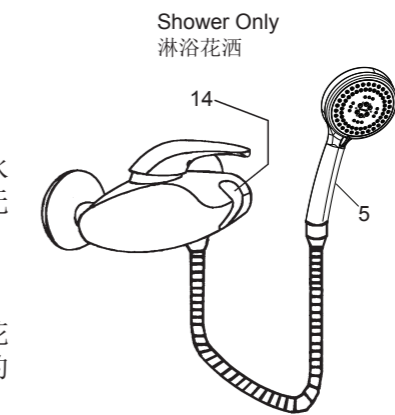
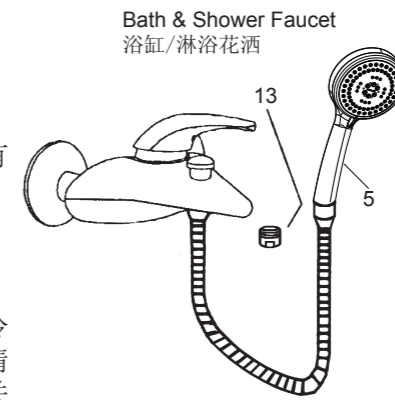

INSTALLATION CHECKOUT

Ensure that all coupling nuts are tight. Ensure that the lever handle is in the close position.

Turn on the main water supply, and check for leaks. Repair as needed.

Bath & Shower Faucet:

Remove the aerator(13) and handspray. Run hot and cold water through the faucet for about one minute to remove any debris. Check for leaks. Remove any debris from the aerator assembly. Shut the faucet off, and reinstall the aerator assembly and handspray.

Shower Only:

Remove the handspray(5). Run hot and cold water through the faucet for about one minute to remove any debris. Check for leaks. Shut the faucet off, and reinstall the handspray. According to the need of the hight, insert the handspray to the articulated bracket or the shower bracket(14) on the body when you take a shower.

清理说明

适用于所有加工处理过的表面：以中性肥皂水清洗镀层表面，再以干净的软布彻底擦干整个表面，许多清洁剂，比如氨水、去污粉及洁厕灵等，会对电镀表面造成伤害，切忌使用。

有磨损性的清洁用具或清洁剂也不可适用于科勒牌的水龙头及其配件上。

CLEANING INSTRUCTIONS

All Finishes: Clean the finish with mild soap and warm water. Wipe entire surface completely dry with clean soft cloth. Many cleaners may contain chemicals, such as ammonia, chlorine, toilet cleaner etc. which could adversely affect the finish and are not recommended for cleaning.

Do not use abrasive cleaners or solvents on Kohler faucets and fittings.