

BEFORE YOU BEGIN

- Please read these instructions carefully to familiarize yourself with the required tools, materials, and installation sequences. Follow the sections that pertain to your particular installation. This will help you avoid costly mistakes. In addition to proper installation, read all operating and safety instructions
- All information is based on the latest product information available at the time of publication. Kohler China Ltd. reserves the right to make changes in product characteristics, packaging, or availability at any time without notice.

安装之前

- 请仔细阅读此说明书以熟悉所需要的工具、材料及安装顺序。遵循适合您的特定安装要求的各项内容，避免昂贵的损失。除了要正确安装外，还应阅读操作及安全说明。
- 所有的资料是按最新出版的产品资料编写而成。科勒中国有限公司保留任何时候无须通知即可改变产品特性、包装或产品可供类型的权利。

NOTES

- Observe all local plumbing and plumbing codes.
- Inspect waste and supply tubing; replace if necessary.
- The drain has removable parts.
- Drain "T" is reversible for vertical or horizontal drainage.
- Do not use sharp and hard objects when taking out the drain plug to avoid scratching it.

注意事项

- 遵守所有本地的水管安装及施工规程。
- 检查污水及供水管道。如有必要，即予更换。
- 下水装置具有可拆卸式零件。
- “T”型下水可用于垂直或水平式排水。
- 在拔取落水塞的时候，注意不要使用硬物，避免划伤。

Tools Required

- Assorted screwdrivers
- Adjustable or open end wrench
- Pipe wrenches
- Pliers
- Manual hacksaw
- Long flat nose pliers

所需工具

- 各种类型的螺丝刀
- 活络扳手或开口扳手
- 管子钳
- 老虎钳
- 手动钢锯
- 尖嘴钳

ROUGHING-IN

尺寸图

Reference Value
参考值

UNIT: mm
单位: 毫米

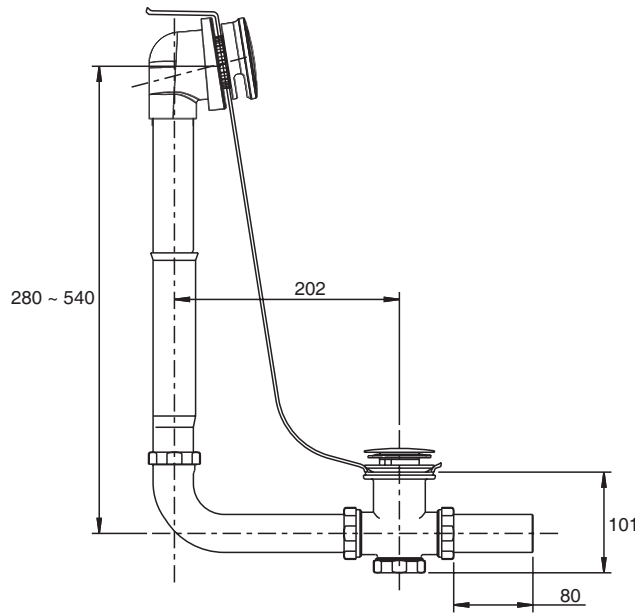

Fig.#1
图1

Kohler reserves the right to change marked dimensions without prior notice.
科勒公司保留随时变更图中标示尺寸的权利，无需另行通知。

INSTALLATION PREPARATIONS

安装准备

Pull out the control wire head from the bottom of overflow pipe. Insert a string into the back of the button and pull out the whole control wire assembly.

从溢水管底部拔出控制线头，再从溢水头处用细绳嵌入按钮后面拉住按钮向外将整条控制线组件拔出。

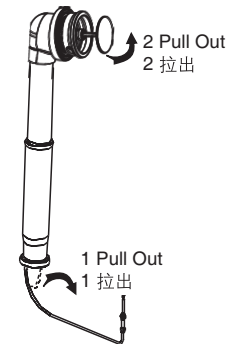

Fig.#2
图2

Disassemble the overflow plate kit and the base kit from the overflow base.

从溢水座上将溢水面板组件和基座组件拆下。

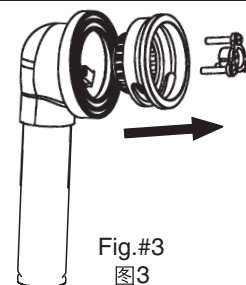

Fig.#3
图3

Pull the plug off the drain body.

用力将止水塞从排水座上拔出。

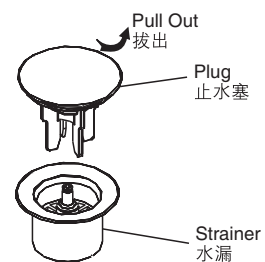

Fig.#4
图4

Unscrew the valve body using packed wrench.

用随附十字扳手将开关组件从水漏中旋出。

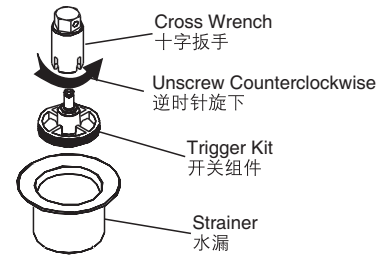

Fig.#5
图5

INSTALLATION 安装

Insert strainer into the gasket, position plain gasket between the drain ell and the bottom of the bath. Turn the strainer into the drain ell.

将碗形垫圈套在过滤网上，同时将平垫圈放在下水弯头与浴缸底部之间。将过滤网拧入下水弯头内。

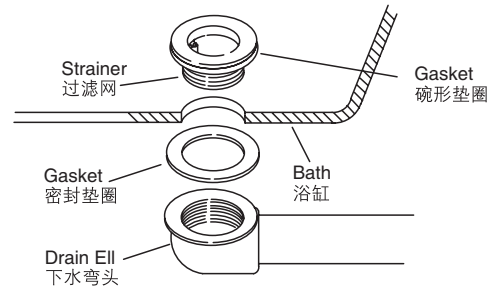

Fig.#6
图6

Wrap the plier head with adhesive tape and then insert it into the top of the strainer to tighten the drain ell securely, as shown. Make sure the drain ell tube is facing the front of the bath. Then apply silicone sealant around the strainer.

将钳子的尖部缠上胶带，插入过滤网的顶部，拧紧下水弯头，如图所示。确保下水弯头管正对着浴缸的前端。然后在水漏外围四周打上密封硅胶。

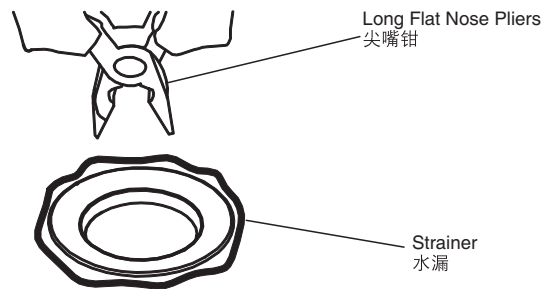

Fig.#7
图7

When installing baths with different height, you may need to cut the pipes as shown to suit the height of the bath.

安装不同高度浴缸时，可能需要在管道标记处截断管道，以适应浴缸高度。

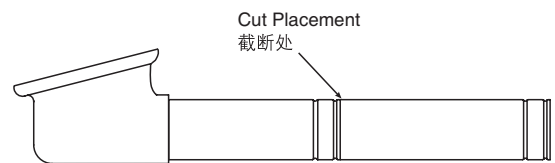

Fig.#8
图8

Attach the gasket to the overflow ell, as shown. Apply silicon sealant.

将密封垫圈套在溢流弯头上，如图所示。并打上硅胶。

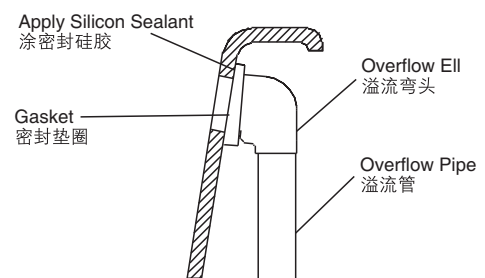

Fig.#9
图9

Assemble the overflow plate kit and the base kit back to the overflow base from the inside of bath tub.

从浴缸内侧将溢水面板组件和基座组件装回到溢水座上。

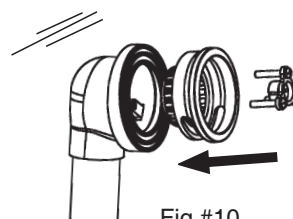

Fig.#10
图10

For vertical drainage installations: assemble parts as shown. Align the parts with the drain base. Align and tighten the nuts.

垂直排水方式的安装：如图所示安装各零件。将各部位对准排水座四通，将管子插进四通，并拧紧螺母。

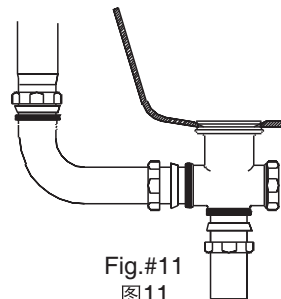

Fig.#11
图11

For horizontal drainage installations: assemble parts as shown. Align the parts with the drain base. Align and tighten the nuts.

水平排水方式的安装：如图所示安装各零件。将各部位对准排水座四通，将管子插进四通，并拧紧螺母。

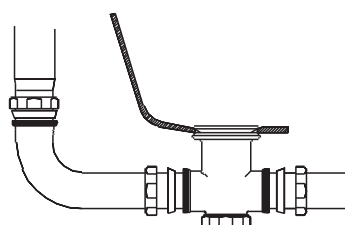

Fig.#12
图12

Insert the control wire into the center of the overflow hole.

将控制线尾部从溢水孔中心插入。

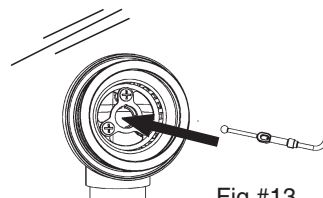

Fig.#13
图13

After inserting the whole control wire, insert the rib on the button into the slot on the button base until a "click" is heard.

待控制线完全插入后，将按钮座上的筋对准基座上的槽插入。直至听到“咔”声，即安装到位。

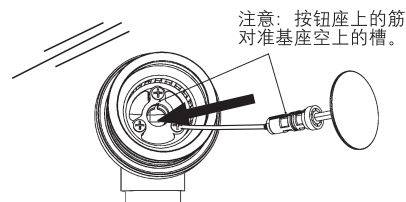

Fig.#14
图14

Pull the tail of control wire from the drain hole.

从排水孔处将控制线尾端拽出。

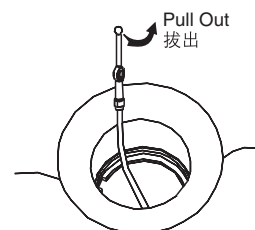

Fig.#15
图15

Remove the rubber cover from the wire as shown, then fasten the control wire with the trigger kit.

拿掉控制线尾端的橡胶保护套，并将控制线旋到开关组件上。



Fig.#16
图16

Hide the control wire into the pipe as shown.

⚠ Note: Do not over bend the wire at all bending positions. Leave arcs as big as possible to avoid too much pressure. Otherwise, the button may not restore to its original position.

将多余的控制线藏于排水管中，如图示：

⚠ 注意：所有弯折处不可折死控制线，需要留有尽量大的圆弧，否则按压压力将过大，或按钮不复位。

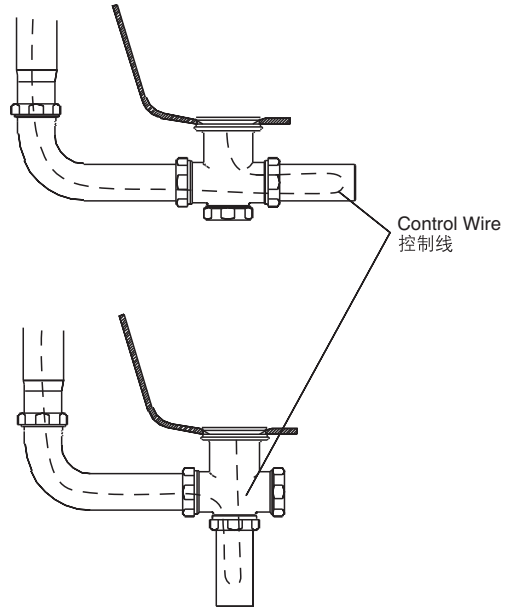

Fig.#17
图17

Fasten the trigger kit on the strainer.

将开关组件拧紧到水漏上。

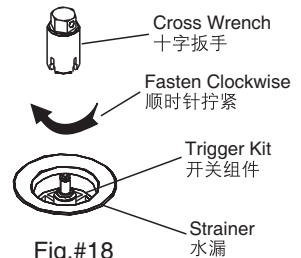

Fig.#18
图18

Push the button on overflow, so the ejector pin of the trigger kit on high position, then push the plug on the trigger kit until a "click".

按动溢水处按钮，使开关组件顶杆处于高位，将止水塞按下，“咔”声后即可。

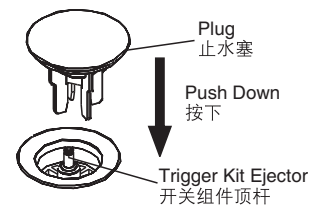

Fig.#19
图19

Attention:

After install, push the button repeatedly, make sure the plug could open and close normally. Run water into the bath, check the drain connections for leaks.

注意：以上安装步骤完成后，反复按压溢水处按钮，确认止水塞能正常开闭。注水入浴缸，检查排水配件处是否有渗漏。

MAINTENANCE

产品维护

- Pull off the plug, unscrew the trigger kit, pull the control wire out to clean the hair on the wire.
- The accessories should be washed with warm water and a soft cloth or sponge. Do not use abrasive cleaners or cleaners containing bleach.

- 将止水塞拔出，旋出开关组件，抽出控制线即可清理控制线上的毛发。
- 为了更好地保养本品，请您用温水和软毛巾（或海绵）擦拭，含有腐蚀剂或漂白剂的洗洁剂对本品有害。

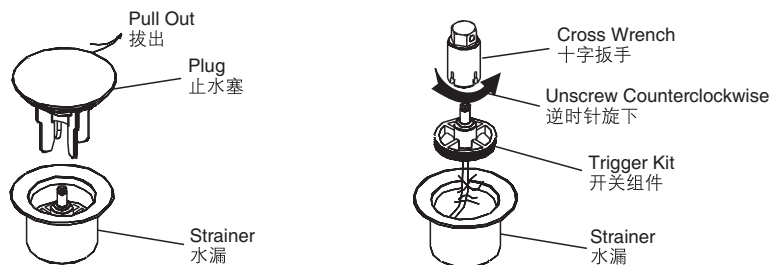

Fig.#20
图20