

18055T-B-CP	黛诗台盆感应龙头—直流电(冷热混合型)
18057T-B-CP	黛诗台盆感应龙头—直流电(单冷型)
18075T-B-CP	黛诗台盆感应龙头—交流电(冷热混合型含交流电源盒)
18076T-B-CP	黛诗台盆感应龙头—交流电(冷热混合型)
18077T-B-CP	黛诗台盆感应龙头—交流电(单冷型含交流电源盒)
18078T-B-CP	黛诗台盆感应龙头—交流电(单冷型)

安装之前

所有的资料是按最新出版的产品资料编写而成。科勒公司保留任何时候不经通知即可改变产品特性、包装或产品可供类型的权利。说明书包括重要的安装、保养及清洁方面的内容，请把这些资料交给用户阅读。

注意事项：

1. 一定要先彻底冲洗供水管以清除管道中的杂质，使用水源为自来水或可供饮用水。
2. 请勿将强力及冲击施于产品，以免造成故障，引起漏水。
3. 安装、清洁龙头时，切勿损伤感应窗口表面，以免造成故障。
4. 如果是安装新的洗面盆，可将水龙头和排水组件先安装好到面盆上。
5. 对于直流龙头，安装时注意电池的正负极不能装反，电池盒盖要拧紧，防止电池受潮。
6. 对于交流龙头，安装时务必按照说明书的要求正确连接导线，龙头安装完毕后才可向电源盒供电。
7. 一个交流电源盒最多可供两个感应龙头。
8. 交流电的总电源必须有合适熔断丝加以保护。
9. 请勿使产品感应窗口靠近强紫外线或电磁场。
10. 为保证龙头正常工作，请务必安装连接组件。
11. 对于冷热混水龙头，先将连接热水的角阀关闭，以免烫伤。
12. 修理面盆时，用黑色电工胶布粘住感应窗口。

BEFORE YOU BEGIN

All information is based on the latest product information available at the time of publication, Kohler Co. reserves the right to make changes in product characteristics, packaging, or availability at any time without notice. Please deliver these instructions for the consumer. They contain important installation, maintenance and cleaning information.

NOTES:

1. Flush the water supply pipes thoroughly to remove debris. Faucet is designed for tap water or potable water.
2. Do not attack the faucet with rough strength to avoid being damaged.
3. Do not damage the surface of sensing window when installing or cleaning the faucet.
4. For new installations, install the faucet and drain to the lavatory before installing the lavatory.
5. As for DC type faucets, please pay special attention to insert direction matches battery poles. Tighten the battery cover completely to prevent its exposure to moisture.
6. As for AC type faucets, strictly follow indicated instructions to perform electric connection. Only provide electric supply to power box after the installation is completed.
7. One AC/DC transformer for max.two faucets.
8. Electrical source must equipped with suitable fuse to protect AC/DC transformer unit from damage.
9. Do not put the faucet near strong ultraviolet or electromagnetic field.
- 10.To ensure faucet proper operation, please install connectors.
- 11.For faucet with temperature mixer, please turn off valve before connecting to hot water to avoid scalding.
- 12.Cover the sensing window with black tape when repairing lavatories.

科勒（中国）投资有限公司
制造商：上海科勒电子科技有限公司
中国上海宝山区丰翔路1955号 邮编：200444

安装之前 (续)

BEFORE YOU BEGIN(Continued)

13. 维修交流龙头时，必须断开交流电源并关闭水源。

13. Turn off the electrical source and shut down water supply before servicing faucet.

使用说明

OPERATION INSTRUCTIONS

1. 手伸到出水口下方感应范围内（感应距离随面盆、周围的情况而自动调节），水龙头出水。手离，0.5~1秒，水龙头自动止水。

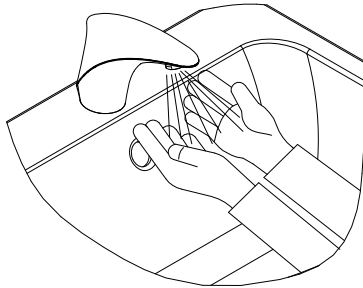

1. Put your hand in the sensing -range, the faucet should turn on. The faucet should turn off after removal within 0.5~1 second. The sensing distance will be adjusted automatically per the condition of the lavatory and surrounding environment.

2. 冷热混水龙头水温调节：先关闭热水角阀，再将冷水角阀旋至冷水最大状态，再缓慢打开热水角阀，以免烫伤。如冷水水压大，打开全部热水角阀后，仍无合适水温，请再缓慢减少冷水出水量，直至水温使用舒适。

2. Adjust the water temp for faucet with temperature mixture: turn off hot water valve first, and then turn on the water and adjust to full cold, slowly turn on hot water valve to avoid scalding. If cold water pressure is high and unable to gain proper comfortable water temp even hot water valve is fully open, turn down cold water capacity slowly until water temp is comfortable for use.

建议搭配脸盆

RECOMMENDATION OF MATCHING LAVATORY

K-2297 凯瑟琳台下脸盆
K-2889T 维克长方形台下盆
K-2215T-M 拉蒂纳台下脸盆
K-2949T 拂朗台下脸盆
K-2319 贝卡夫台下盆
K-2211T 卡斯登台下脸盆
K-2940T 温蒂斯台下脸盆
K-99184T 乔司 21"椭圆形台下盆
K-2881T 维克椭圆形台下脸盆
K-2883 维克圆形台下脸盆
K-2768T-1 皓玥台下盆
K-18572T-1 瑞琦一体化盆
K-18571T-1 瑞琦一体化盆

K-2297 Kathryn® Undercounter Lavatory
K-2889T Verticyl® Rectangular Undercounter Lavatory
K-2215T-M Ladena® Undercounter Lavatory
K-2949T Forefront™ Undercounter Lavatory
K-2319 Bancroft® Undercounter Lavatory
K-2211T Caxton® Undercounter Lavatory
K-2940T Vintage® Undercounter Lavatory
K-99184T Chalice™ Undercounter Lavatory
K-2881T Verticyl® Oval Undercounter Lavatory
K-2883 Verticyl® Round Undercounter Lavatory
K-2768T-1 Karess Undercounter Lavatory
K-18572T-1 Reach™ Vanity Top
K-18571T-1 Reach™ Vanity Top

建议搭配脸盆 (续)

RECOMMENDATION OF MATCHING LAVATORY(Continued)

K-2979-1 纽英伦一体化台盆
K-2749T 拂朗长方形一体化台盆
K-11479-VC1 拂朗半嵌入式脸盆
K-2196T-1 斑宁登修边式台上脸盆

K-2979-1 Tresham™ Vanity Top
K-2749T Forefront™ Vanity Top
K-11479-VC1 Forefront™ Semi-Recessed Lavatory
K-2196T-1 Pennington® Self-rimming Lavatory

注意:

如果使用非推荐的脸盆, 可能会产生溅水在脸盆外面等情况。

NOTE:

Water spraying out of countertop might happen when countertop out of the recommendation list is selected.

安装尺寸(毫米)

ROUGH-IN DIMENSIONS (mm)

18055T-B-CP
黛诗台盆感应龙头-直流电 (冷热混合型)

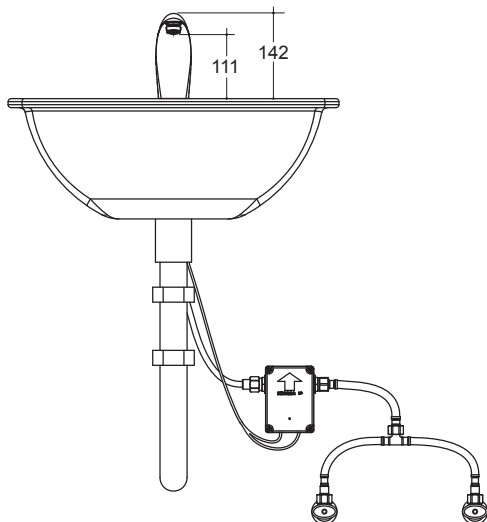

18057T-B-CP
黛诗台盆感应龙头-直流电 (单冷型)

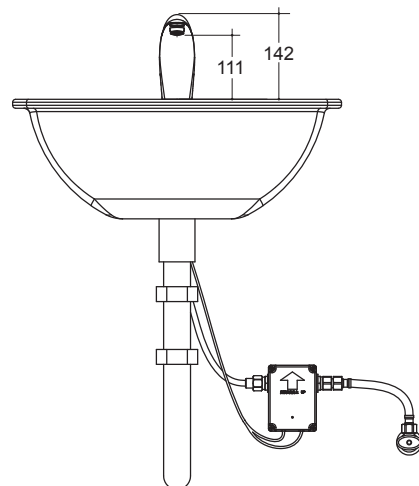

安装尺寸(毫米)(续)

ROUGH-IN DIMENSIONS(mm) (Continued)

18075T-B-CP

黛诗台盆感应龙头-交流电 (冷热混合型含交流电源盒)

18077T-B-CP

黛诗台盆感应龙头-交流电 (单冷型含交流电源盒)

18076T-B-CP

黛诗台盆感应龙头-交流电 (冷热混合型)

18078T-B-CP

黛诗台盆感应龙头-交流电 (单冷型)

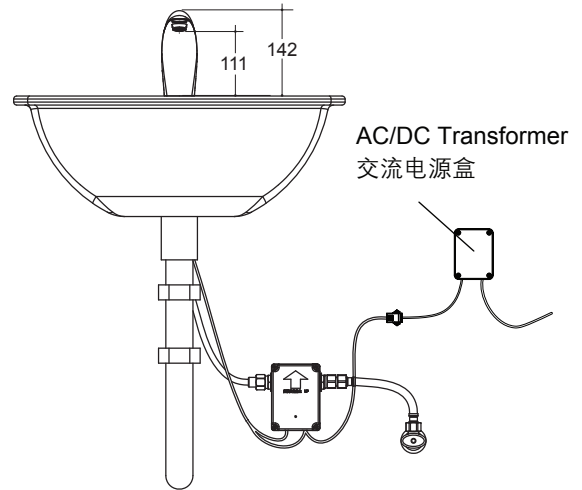
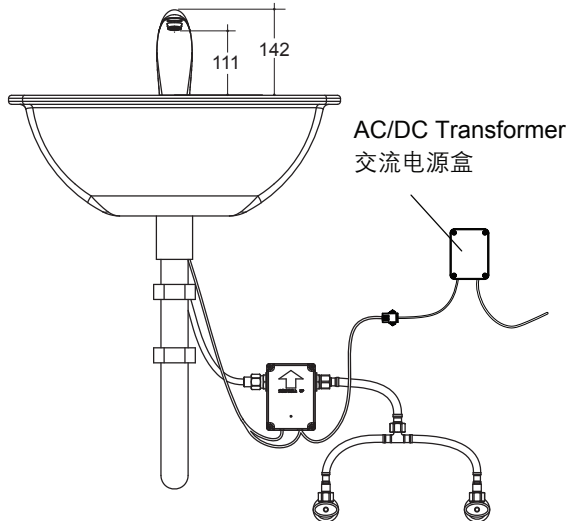

AC/DC Transformer
(Not contained in 18076T-B-CP, 18078T-B-CP, need purchasing)
交流电源盒
(18076T-B-CP、18078T-B-CP需另购)

Drain
排水组件

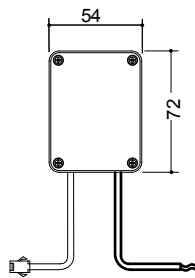

Output: DC6V Input: AC220V
输出: 输入:
直流电压6V 交流电压220V

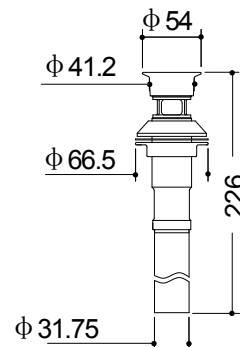

技术参数

电源：直流 4节5号碱性电池(LR06×4)
交流 电压220V, 频率50/60Hz
检测时间：小于0.5秒
关阀延时：0.5~1秒
感应距离：自动调节
流量：水压为0.3MPa时，流量不大于2.0L/min
超时用水控制：超时用水1分钟，自动止水。
环境温度：1~55℃
进水温度：0.5~71℃
适用水压：0.05~0.86MPa

PARAMETERS

Power: DC 4 pieces of AA size alkaline batteries
AC 220V, 50/60Hz
Sensor Duration: Less than 0.5s
Shut-off Delay: 0.5~1s
Sensing Distance: Automatic adjustment
Flow Rate: No more than 2.0L/min at 0.3MPa.
Overtime Flowing Control: Automatically stop flushing when the faucet senses an object for more than 1 minute continuously
Ambient Temperature: 1~55℃
Supply Water Temperature: 0.5~71℃
Supply Water Pressure: 0.05~0.86MPa

安装步骤

INSTALLATION

如何安装水龙头

一 龙头与面盆的安装固定

将固定螺杆(2)安装到水龙头(1)底部处。再把垫片(3)套在固定螺杆上。并嵌入水龙头底部的盘槽中。然后将电源线(7)和进水软管(8)穿过安装孔，从面盆下方将固定橡胶垫片(4)固定金属垫片(5)和固定螺母(6)对齐固定螺杆向上套入。调整水龙头电源线及进水软管的位置。用扳手拧紧固定螺母以便把水龙头固定在面盆上。

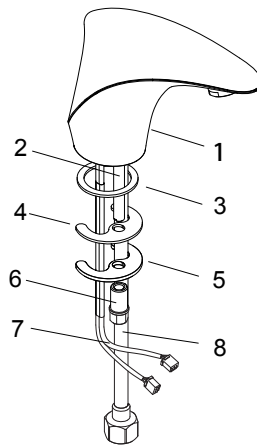

How to Install the Faucet

1. Fasten faucet on lavatory:

Install the stud (2) to the underside of the faucet (1). Slide the gasket (3) over the stud, and then seat the gasket in the groove on the underside of the sprout. Cross power cord (7) and water inlet hose (8) through mounting hole, slide rubber washer (4), metal washer (5) and nut (6) onto the stud from under the sink. Adjust faucet power cord and water inlet hose position, fasten nut to secure faucet on lavatory mounting surface by wrench.

二 安装控制组件

按下控制盒盖(10)螺钉(11)，打开控制盒(9)，根据安装尺寸图(图一)在墙壁合适的位置钻孔，打入膨胀管(12)，使控制盒紧贴墙面，再用螺钉(13)将其固定在墙壁上。

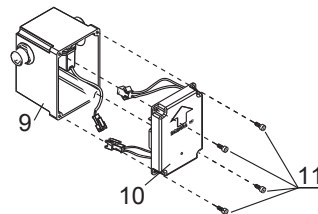

2. Install Control Assy.

Unscrew valve cover (10) screw (11) by screwdriver, open valve cover (9). Determine proper mounting location per rough -in (Fig 1), then punch expansion tube (12) in. Place valve box against the wall and then secure control valve assembly on the wall by bolts (13).

注意：控制盒长边端需竖直放置，出水口位置可根据需要左右调整。

将软管(16)一端与三通进水软管组件(17)连接，另一端与控制组件(15)进水口连接，再将出水口与龙头出水软管(14)连接，三通进水软管组件另外两端与角阀(18)连接。

对于单冷龙头，将软管一端与滤网接头(19)相连，另一端与角阀连接即可。

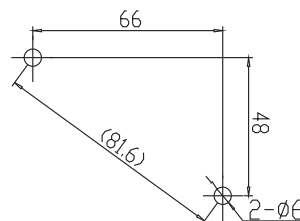

图一

Note: place the long end of control box upright, water outlet position shall be adjusted left/right based on requirements.

Connect hose (16) to Tee water inlet hose assembly(17), and then connect water outlet with faucet water outlet hose (14). Connect Tee water inlet hose other two ends with valve (18).

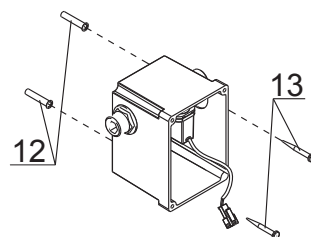

For cold water faucet, connect hose to the cylinder(19) and then connect with valve.

注意:

- 1. 请勿将进水口与出水口混淆;
- 2. 进水口处滤网组件不能漏装;
- 3. 出水口处平垫不要漏装。

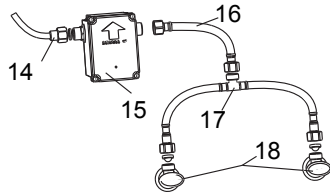

混水(Mixer): 18055T-B-CP, 18075T-B-CP, 18076T-B-CP

Note:

- 1. Do not mix water inlet with water outlet.
- 2. No missing screen assembly on water inlet.
- 3. No missing flat washer on water outlet.

三 安装电池组件

1. 取出电池盒组件，旋松螺钉(20)，按电池盒盖(21)上的正负极标示装入4节5号电池，紧锁电池盒盖的螺钉。

注意: 电池极性不能装反，新旧电池不能混用。

2. 将所有导线根据对应的颜色连接上，再将电池盒组件放在控制组件内空旷处，合理调整位置，将合盖根据安装方向用螺钉紧固在控制盒上。

对于交流龙头，除对应的导线连接到交流电源盒输出端上，其余安装方式一致。

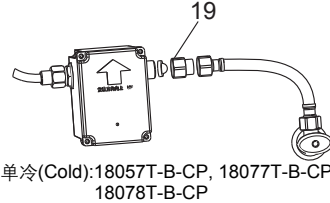

单冷(Cold): 18057T-B-CP, 18077T-B-CP, 18078T-B-CP

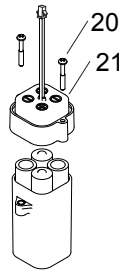

3. Install battery assembly

1. Take battery box out, loose screws (20), insert 4 pieces of AA battery per +/- pole indication (21) on battery box cover. Fasten battery box cover screws.

Note: no reversed battery polarity. Do not mix new and used batteries together.

2. Connect power cords with corresponding color wires, then place battery box assembly to empty space within control assembly then fasten control box by screws based on installation direction. For AC faucet, except corresponding cords connect to AC/DC transformer output, other installation methods are identical.

四 如何安装排水组件

旋下排水器盘片(22)，在其底面沿周围涂上一圈密封油灰。把排水本体(23)由底下插入面盆。

Apply plumbers putty
涂油灰

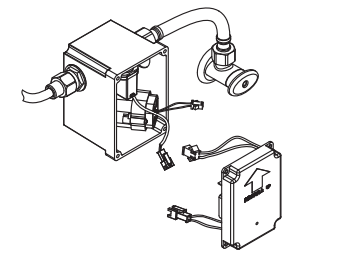

4. How to Install the Drain

Screw the drain flange (22) off from drain assembly. Apply plumbers putty around the bottom circle. Insert drain body (23) into lavatory from the underside.

把排水器盘片(22)旋入排水本体(23)。从下方用手拧紧锁紧螺母(24)，去除多余的油灰。

注意: 在锁紧螺母(24)拧紧后，不可再调整排水本体的位置，否则将会破坏油灰密封。

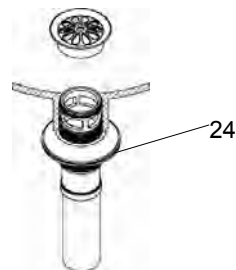
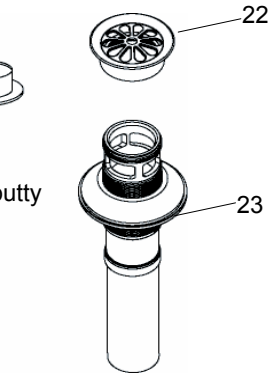

Screw the drain flange (22) into drain body (23). Tighten the locknut (24) manually from the underside.

Note: Remove excessive putty. **Note:** after tighten locknut (24), do not adjust drain body position, otherwise putty seal might be damaged.

把尾管(25)接上存水弯(26)，尾管需插入存水弯25mm到55mm之间。

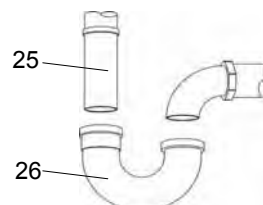

Connect the tailpiece(25) to the trap(26). The tailpiece should extend 25mm to 55mm into the trap.

如何安装交流电源盒
(仅限于交流感应龙头)

HOW TO INSTALL THE AC/DC
TRANSFORMER (FOR AC
TOUCHLESS FAUCET ONLY)

一个交流电源盒供一个感应龙头
One AC/DC transformer supply one touchless faucet

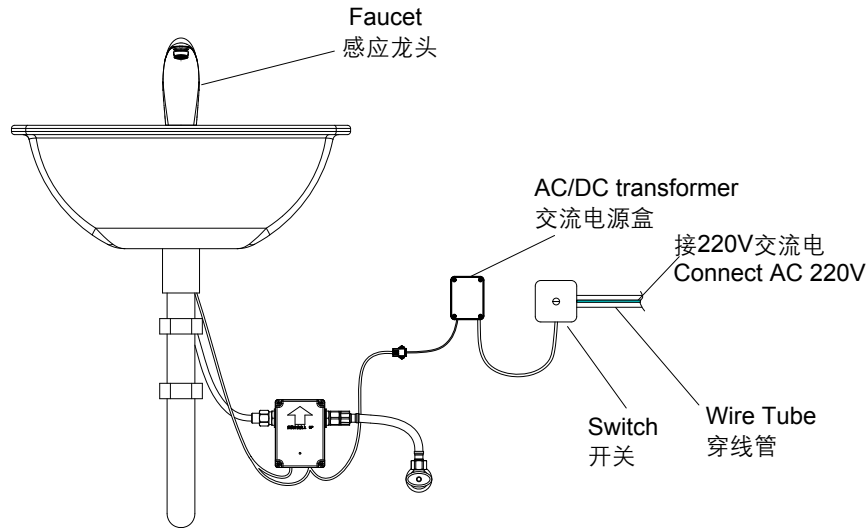

一个交流电源盒供两个感应龙头
One AC/DC transformer supply two touchless faucets

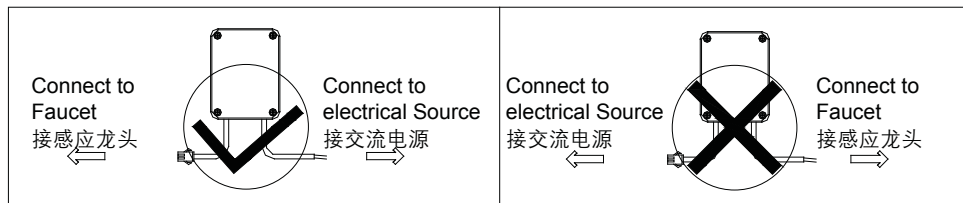
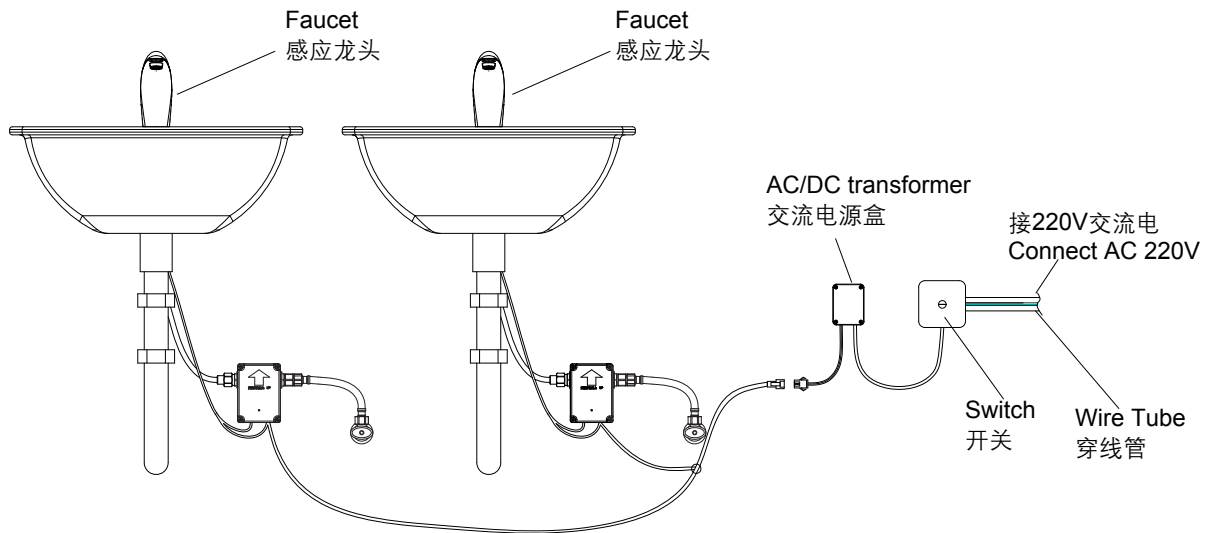

注意：禁止将交流AC220V接入直流DC接线端。

Note: connect AC 220V electrical source directly to DC connector is not allowed.

注：18076T-B-CP、18078T-B-CP交流电源盒需另购。

Not contained in 18076T-B-CP, 18078T-B-CP, need purchasing

1.电源盒(背面有不干胶)应安装在干燥,不会被水淋湿、浸泡的位置。根据需要客户自备穿线管及连接线。穿线管安装在墙内。建议交流电源线采用带绝缘和护套层的电线,导体标称截面积 $\geq 0.5\text{mm}^2$;直流连接线采用导体标称截面积 $\geq 0.3\text{mm}^2$ 的电线。请严格按照上图进行连接。

2.排线完毕后,应检查并确保所有排、接线无误,再分别连接电源盒AC接线端与排线管内交流接线端,以及电源盒DC接线端(黑橙线接头)与龙头的电源线接插件(从阀盒内引出的电线),最后打开AC电源,龙头进入2分钟自动调距阶段,此过程龙头不会出水。

1.Power unit (sticker on the back) should be installed at a dry place and avoid showering, soaking from water. Customer prepare wire tube and wire according to requirement. Wire tube should be mounted into the wall. Suggested wire: AC connection wire adopts wires with protecting layer or sleeve and the section should be $\geq 0.5\text{mm}^2$. The section of DC connection wire should be $\geq 0.3\text{mm}^2$. the connection pattern must follow the illustrations above.

2.After wire layout finished, check and repair if needed. Then connect AC connector to AC connector within FPC pipe, DC connector (black-orange) on electrical box to faucet power cord connector (wire from valve box). Finally turn on AC power source, faucet enter auto sensing distance adjusting phase about 2min. The faucet will not work during this period.

如何转换成恒温阀感应龙头
(若用户另购恒温阀16294T-3-CP,
具体安装详见其说明书)

HOW TO CHANGE TO THERMOSTATIC
SENSOR FAUCET (If users purchased the
thermostatic valve 16294T-3-CP, please refer to
the installation guide 16294T-3-CP)

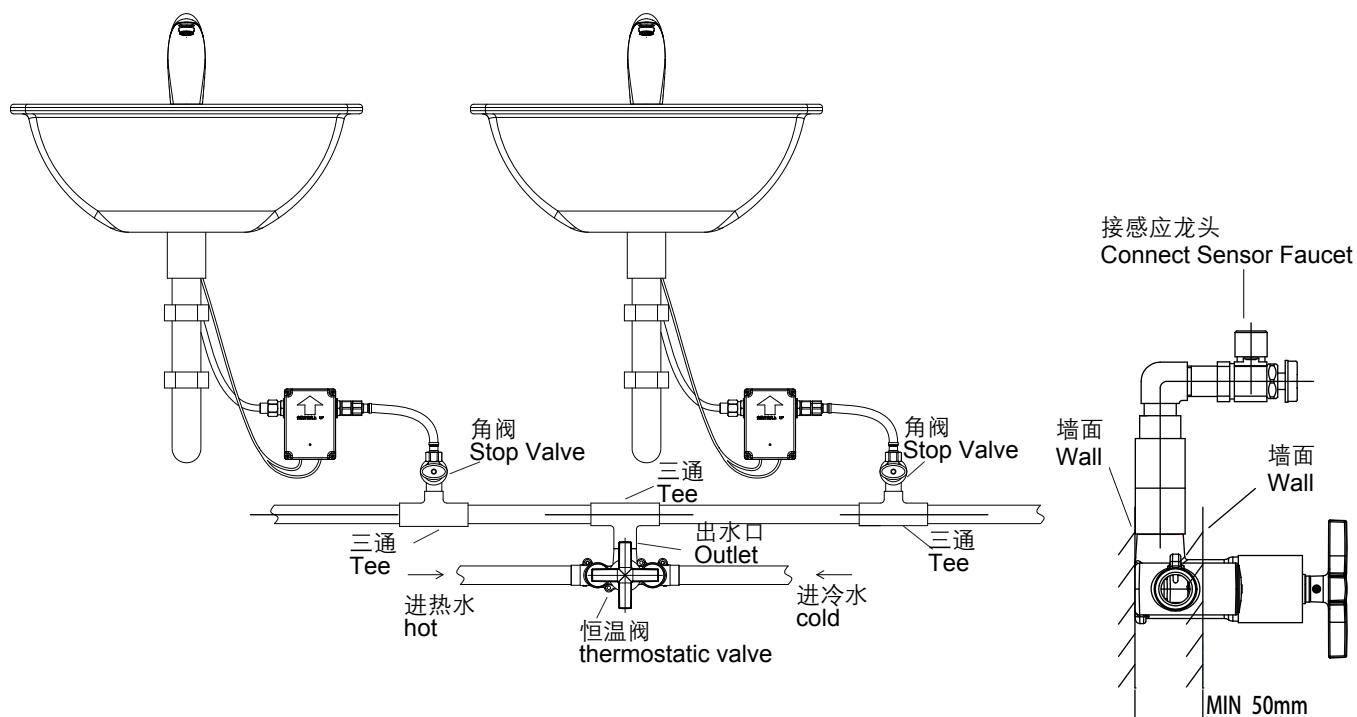

注：三通、角阀请用户自备。

Note: Please prepare the tee and stop valve accordingly.

安装结果检查

INSTALLATION CHECKOUT

检查并确保所有衔接处都已拧紧，打开排水系统和主要供水源，检查并修理有漏水的接口。

Check and ensure that all connections are tight. Open the drain. Turn on main water supply and check for leaks. Repair leakage when necessary.

清理说明

CLEANING INSTRUCTIONS

适用于所有加工处理过的表面，以中性肥皂水清洗镀层表面，再以干净的软布彻底擦干整个表面。许多清洁剂，比如氨水，去污粉及洁厕灵等，会对电镀表面造成伤害，切忌使用。
有腐蚀性的清洁剂或溶剂不可使用于科勒的水龙头及其配件上。

Applicable for all finishes: clean the finish with a mild soap. Wipe entire surface completely dry with a clean soft cloth. Most cleaners may contain chemicals, such as ammonia, chlorine, toilet cleaner etc. which could adversely affect the finish and are not recommended for cleaning. Do not use abrasive cleaners or solvents on Kohler faucets and fittings.

用户须知

IMPORTANT CONSUMER INFORMATION

1. 感应指示灯的各种闪烁情况

感应指示灯是使用者了解感应龙头有效、唯一的途径。所以明白了感应指示灯闪烁所代表的含义，可以正确使用感应龙头，

1. Different Indicator Flashing Indication

The indicator is the only and effective way to learn the faucets working conditions. So the users can use the sensor faucet correctly with knowing the meaning of the sensor indicator's flashing.

用户须知 (续)

IMPORTANT CONSUMER INFORMATION (Continued)

如图示:

(1) 快速闪烁, 代表感应龙头正处于通电后的两分钟自动调节阶段。期间, 安装者、使用者不得干扰其自动调节, 感应范围内不要放置物体。

(2) 间隔6秒钟闪烁一次(直流版本), 表示电池即将使用完, 请更换电池。

(3) 间隔2秒钟连续闪烁: 若直流感应龙头, 代表龙头电池耗尽, 已停止工作, 等待使用者更换电池; 若交流感应龙头, 表示为两种情况: 一种为刚刚停电; 另一种为在交流供电正常的情况下, 则电源盒直流接线端接触不良。

(4) 在正常工作情况下, 当有物体被感应时, 龙头出水, 感应指示灯闪烁一次。

(龙头关闭, 感应指示灯不闪烁)

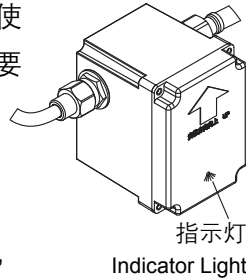

As shown:

(1) Quick flashing means the faucet is in the period of adjusting sensing distance after power on for 2 minutes. During these 2 minutes, please do not disturb auto adjustment, no objects shall be put in the sensing range. (2) The indicator flashes every 6s (DC type) indicates that the unit is out of battery and ceases working. please replace batteries.

(3) The indicator flashes every 2s: as for DC type faucets, this indicates the unit is out of battery and ceases working. Please replace batteries. For AC faucet, it indicates two possibilities: one is that the unit is just out of battery; or poor DC terminal contact under normal AC power supply.

(4) Under normal condition, the water will flow and the indicator will flash once when objects are detected. (The indicator does not flash when faucet stops flowing.)

2. 超时出水控制

连续在感应状态下使用约一分钟, 龙头自动止水。自动止水后, 手或物体离开感应范围后, 再次进入感应范围内, 龙头正常工作, 否则无反应。

2. Timeout setting

When the faucet works for about continuous 1 minute, the faucet will stop flushing automatically. After that, objects must be removed from the sensing range. Then the water will flow when objects enter into the sensing range again. Otherwise, the faucet will not work.

3. 清洗过滤系统

该感应龙头的控制组件内已包含了过滤装置。如管内杂质过多或水质较差, 长期使用会引起出水情况不良。

请按以下步骤清洗过滤装置:

1 关闭角阀。

2 将控制组件进水口处软管拧下, 取出滤网组件, 用水冲洗完毕后, 重新装入。

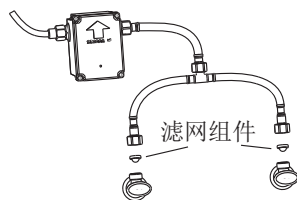

混水(Mixer): 18055T-B-CP,
18075T-B-CP, 18076T-B-CP

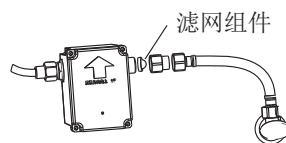

单冷(Cold): 18057T-B-CP,
18077T-B-CP, 18078T-B-CP

3. Clean the Filtration System

The touchless faucet control assembly include filtration device. Poor water outflow shall be caused by excessive impurities inside the hose or poor water quality after long time use. Please clean filtration device per following steps:

1. Turn off stop valve.

2. Pull hose from control assembly water inlet, take filter screen assembly out. Reinstall screen after clean by water.

常见故障排除

以下部分故障现象可通过指示灯闪烁情况识别。（参考“感应指示灯的各种闪烁情况”）

现象	原因	处理方法
不出水 (感应指示灯不闪烁)	无电池或电池装反(直流电) 无电源或接线有误(交流电) 感应范围内有其它物体 感应窗口较脏 接线端未插好、插错	检查电池 检查总电源和接线情况 移开物体 清洁窗口 检查接线端
感应指示灯每2秒快速 闪烁1次而不出水	电池耗尽(直流电) 刚刚停电(交流电) 直流或交流接线端接触不良(交流电)	更换电池 检查总电源 重新连接接插件
感应指示灯闪烁 不出水	刚装机完毕 角阀关闭 过滤装置堵塞 起泡器堵塞	等待2分钟 打开角阀 清洗过滤装置 清洗起泡器
感应指示灯闪烁 出水量小	角阀是否彻底打开 起泡器堵塞 过滤装置堵塞 水压太低	打开角阀 清洗起泡器 清洗过滤装置 检查供水系统
约1分钟以内不止水 (感应指示灯不闪烁)	感应范围内有物体	移开物体

如按以上操作仍未解除故障，请与销售商或科勒(中国)投资有限公司联系。
除安装更换电池外，请勿随意拆卸龙头其它部件。

TROUBLE SHOOTING

Some trouble symptoms can be identified by the indicator's flashing. (Refer to "Note of the Indicator Flashing")

Symptoms	Probable Causes	Corrective Action
No water flow (Indicator not flashing)	No battery or battery wrongly installed No power supply or wrong connection Object in sensing range Dirt on the sensing window The connector does not connect well	Check the batteries Check the power supply and the connection Remove the object Clean the sensing window Check the connector
The indicator flashes once every 2 seconds and the water doesn't flow out.	Batteries are out of power Power shut-down DC or AC connector may not connect well	Replace batteries Check the power supply Reconnect the connector of AC/DC transformer
No water flow while the indicator flashes	Just finishing installation The stop valve is closed The filter is blocked The Aerator is blocked	Wait for 2 minutes Open the angle valve Clean filter Clean Aerator
Low water flow while the indicator does not flash	The stop valve is not open completely The Aerator is blocked The filter is blocked The supply water pressure is low	Open the angle valve Clean Aerator Clean filter Check the water supply system
Keep water running within 1 minute while indicator does not flash	Object in sensing range	Remove object

Please contact with distributor or Kohler China Investment Co., Ltd., if the trouble remains after above-mentioned actions are taken. Please do not disassemble the other parts of the faucet freely except installing and replacing batteries.

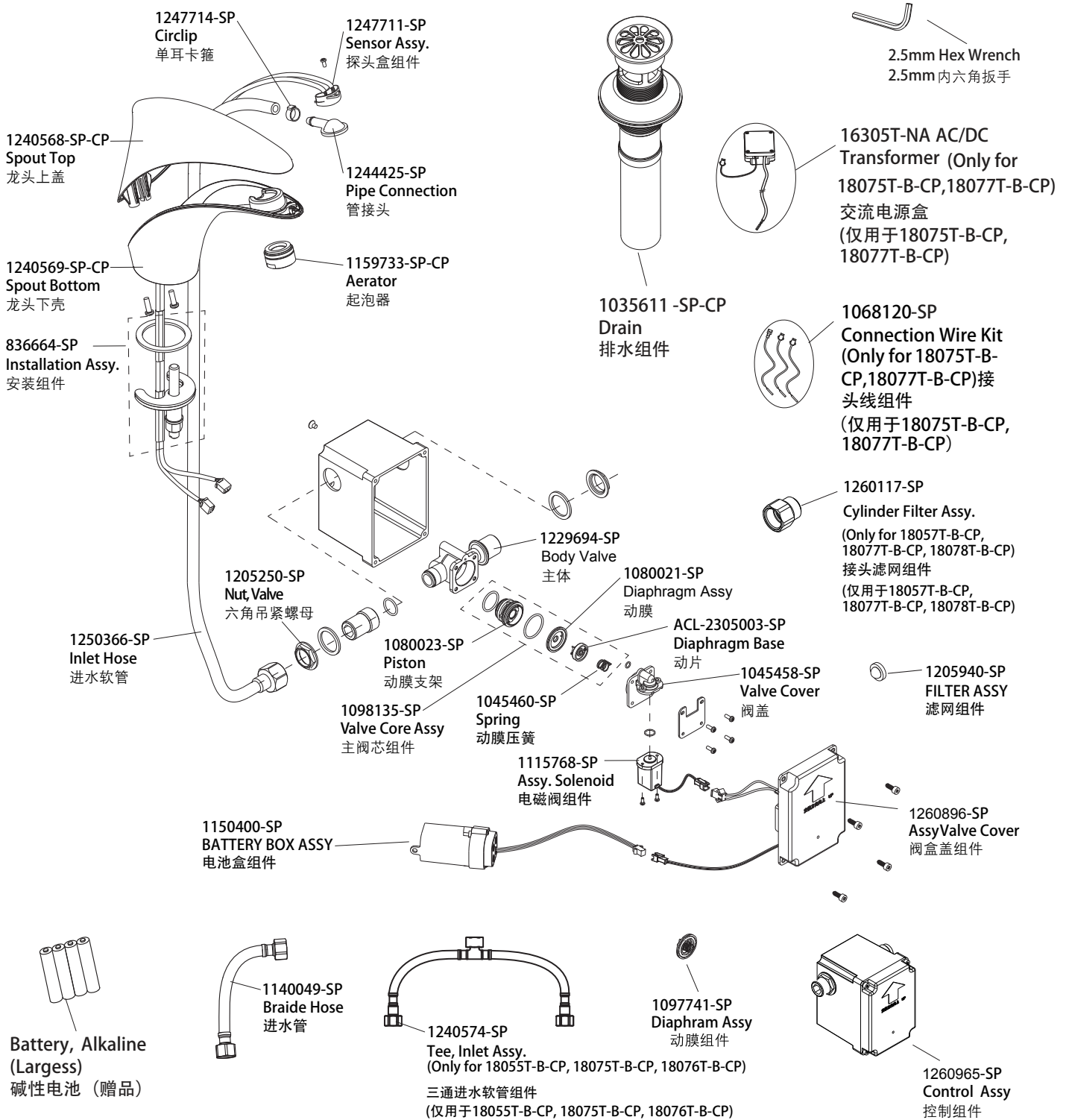

© 版权为科勒中国有限公司所有, 2015

© Copyright Kohler China Ltd., 2015

科勒 (中国) 投资有限公司
 制造商: 上海科勒电子科技有限公司
 中国上海宝山区丰翔路1955号 邮编: 200444

Kohler China Investment Co., Ltd

Manufacturer: Shanghai Kohler Electronic Technology Co., Ltd.
 No.1955, Fengxiang Road. Baoshan Area, Shanghai, PRC Post code: 200444