



BEFORE YOU BEGIN

安装之前

- Please read these instructions carefully to familiarize yourself with the required tools, materials, and installation sequences. Follow the sections that pertain to your particular installation. This will help you avoid costly mistakes. In addition to proper installation, read all operating and safety instructions.
- All information in these instructions is based upon the latest product information available at the time of publication. Kohler China reserves the right to make changes in product characteristics, packaging, or availability at any time without notice.
- These instructions contain important care, cleaning, and warranty information-**please leave instructions for the consumer.**
- Before installation carefully inspect the new fixture for any signs of damage.

- 请仔细阅读本指引，以便熟悉所需工具、物料及安装程序。请遵照适用的章节来安装本产品，以免安装失当导致不必要的损失。除了有关正确的安装方法之外，还务请详阅所有操作及安全指引。
- 本指引所载之一切资料，均以印刷时所有之最新产品情况为基础，科勒中国保留权利随时更改产品特性、包装或供应情况，恕不另行通知。
- 本指引也包含了有关保养、清洁及担保等重要资料-请交予用户保存。
- 安装之前，仔细检查产品是否有损伤。

 **WARNING: Risk of injury or product damage.**
Tempered glass cannot be cut.

 **警告：可能有人员伤害或者产品损坏的危险。**钢化玻璃不能进行切割。

 **WARNING: Don't use acidic or alkalic cleaners or alcohol to clean the wooden surface. Use a dampened cloth to clean.**

 **警告：木质表面不能用含酸或碱性的清洁剂以及酒精清洁，请用潮布清洁。**

PARTS

配件

Parts supplied with your cabinet. (For cabinet body and door replacement, call customer service with model number.) Be sure to check the cardboard supports in the carton, glass parts are packed in them.

浴柜附有零件（柜身及门的补换请致电客服部门并告知型号），请仔细检查包装箱。

ACCESSORIES LIST

附件清单



Wall Anchors
入墙胶粒
X6



Screws ST3.5 x 35
盘头自攻螺钉ST3.5 x 35
X6



Z Clip
Z型安装夹
X2



Glass Shelves
玻璃层板
X1



Screw M8x8
紧定螺钉 M8x8
X4

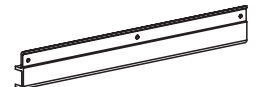

WPS Bracket
WPS支架
X1

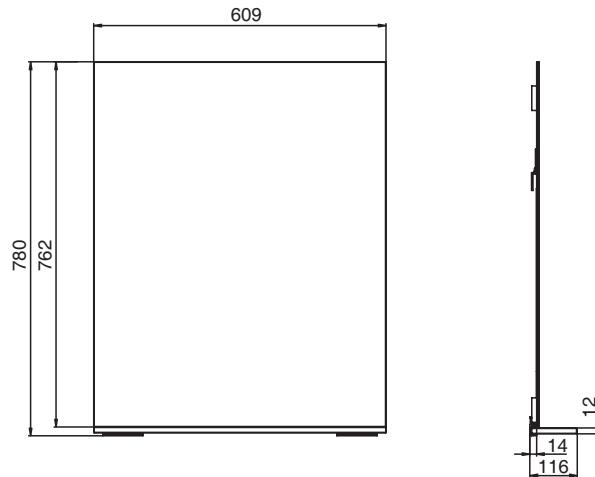

UNIT : mm
单位: 毫米

INSTALLATION

安装

1. Confirm the desired place to install the mirror and the basic outline of the frame.
2. Pre-drill mounting holes by referring to the outline of the frame and the sizes in the picture below.
3. Fix the Z clip and the WPS bracket to the wall with ST3.5x35 screws.
4. Fix the glass shelves to the WPS bracket with M8x8 screws.
5. Fix the mirror onto the Z clip.
6. Connect the wire from the defogger with the 220V/50Hz power supply.

1. 先确定挂镜安装的位置，定出边框基准。
2. 参照边框基准和下图所示尺寸，预钻安装孔。
3. 分别用自攻螺钉将Z型安装夹和WPS支架固定到墙上。
4. 用M8x8紧定螺钉将玻璃层板固定在WPS支架上。
5. 将挂镜安装到Z型安装夹上。
6. 将挂镜上防雾膜引出电线与220V/50Hz电源连接。

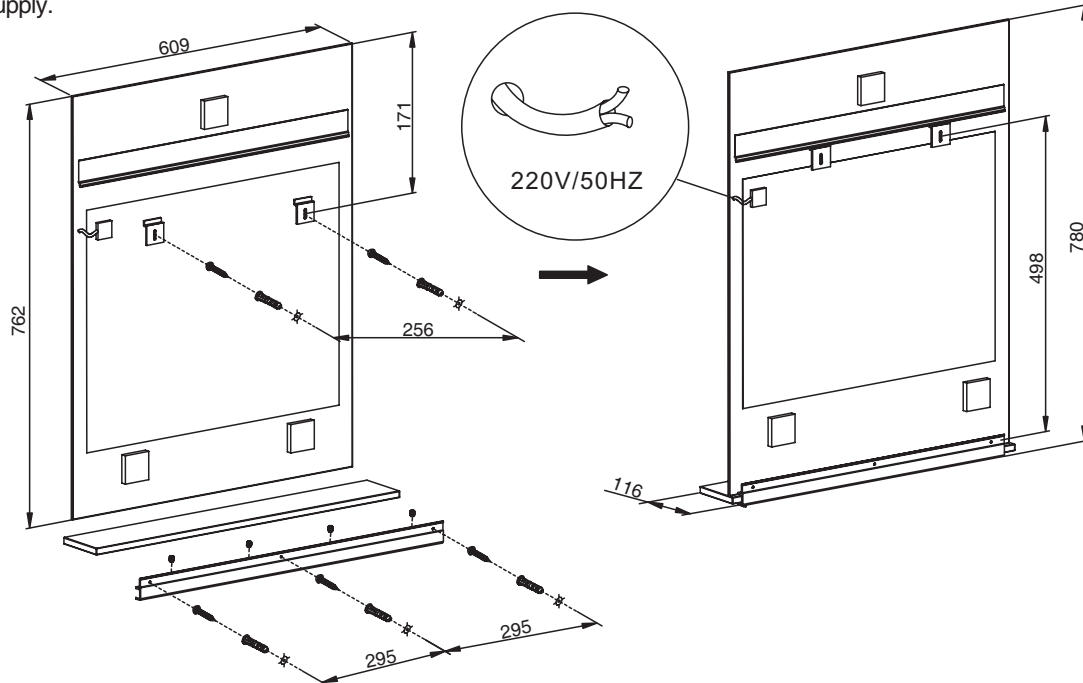

USER MAINTENANCE

日常维护

1. Many cleansers contain abrasive and chemical substance which is not suitable for cleaning stainless steel, enamel, plating or plastic products. You may use mild cleansers or soaps to clean the surfaces. Wipe any splashes of cleaner solutions from the surface with clean soft cloth.
2. Maintain ventilation in the bathroom, and separate the dry area from the damp one if conditions permit. Try to open the door and windows of the bathroom and maintain good ventilation.

1. 许多清洁剂都含有研磨剂及化学物质，不可用于清洁不锈钢、搪瓷、镀层或塑料制品。这些表面须使用温和的清洁剂或皂液进行清洁，将残余洗涤剂洗干净，然后用干净的软布擦干。
2. 卫生间请保持良好的通风状态，有条件的可以干、湿分离，平常尽量保持浴室空气畅通，养成开窗开门的习惯。