

IMPORTANT NOTICE TO INSTALLERS!: Please leave these instructions for the consumer. Please retain for future reference.

NOTE: Some installation parts might not be provided.

NOTE: The toilet pictured in the installation steps may differ from the model being installed.

CAUTION: Turn on the water and allow water to flow through the supply pipe to flush the system of any debris before connecting fill valve.

Type of Trap	S-Trap	P-Trap
Ceramic Trap	225 mm	-
Plastic Trap	305 mm	185 mm

Roughing-in

Unit: mm

P-Trap

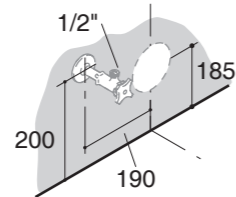

S-Trap

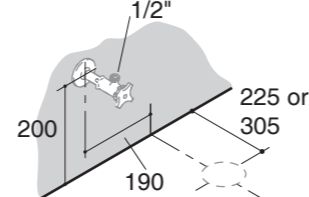

1 Position the template on the floor to ensure the template against the wall.

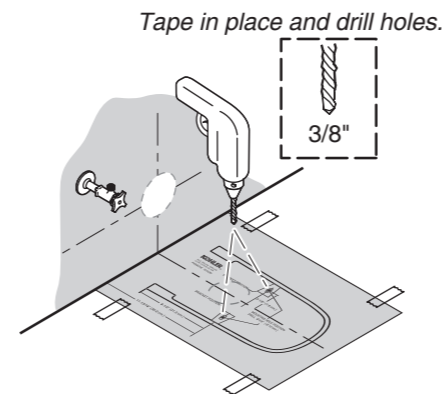

2 Insert the anchors. Position the brackets as shown on the template and install.

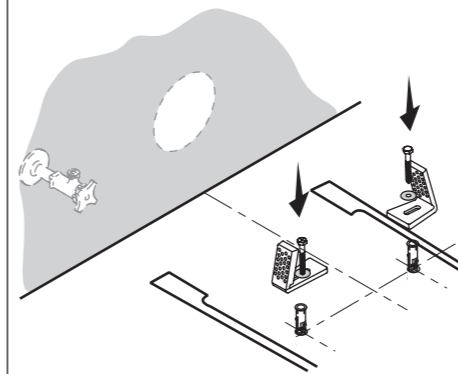

3 Position the tank on the bowl. Slide the rubber washers and washer onto bolts and insert into mounting bowl. Tighten the nuts. **Do not overtighten.**

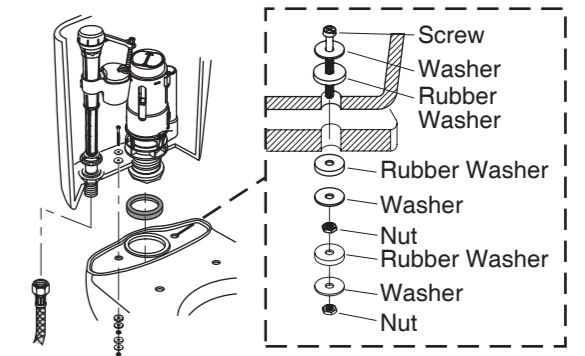

Ceramic Connector

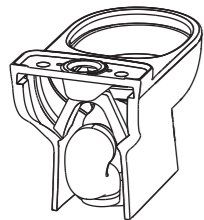

Plastic Connector

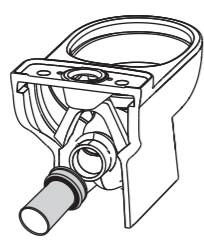
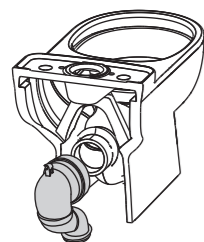

S-Trap

P-Trap

4 Connect the connector on the bowl. Carefully tilt backward until connector and waste pipe touch.

Connector to Wall

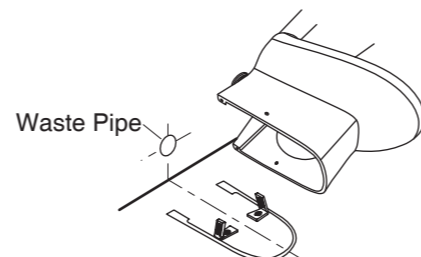
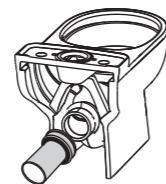

Connector to Floor

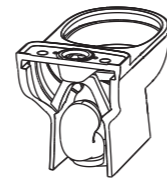
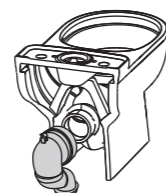

Plastic Connector

Ceramic Connector

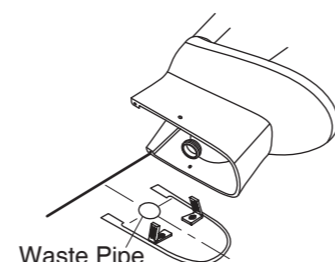

Waste Pipe

5 Align connector and carefully lower over brackets.



6 Apply silicone around base.

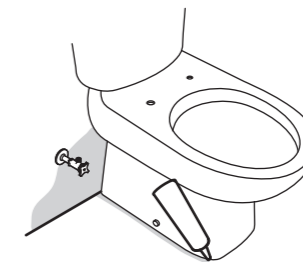

7

Remove the tape and protective pad.



8 Press down on the large button.

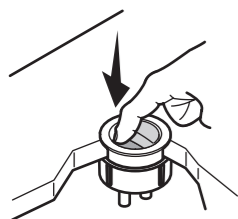

9 Pull out and remove the small button.

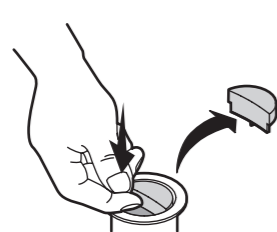

10 Pull out and remove the large button.



11 Insert green rod into small hole. Insert black rod into large hole. Mark the position on both rods along the top of the housing.

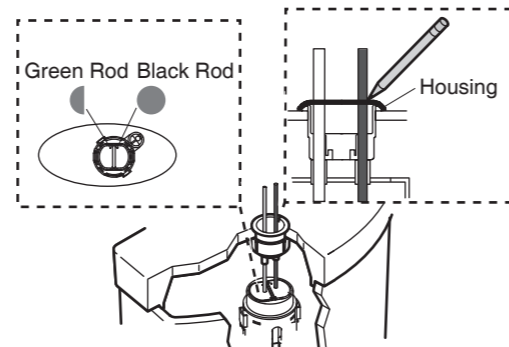

12 Cut both rods, ensure that they are equal the top of push button housing.

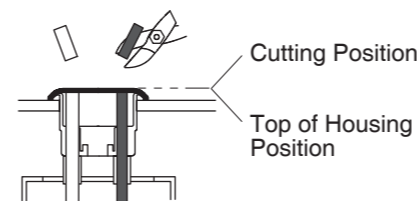

13 Press the large button onto the black rod. Press the small button onto the green rod.

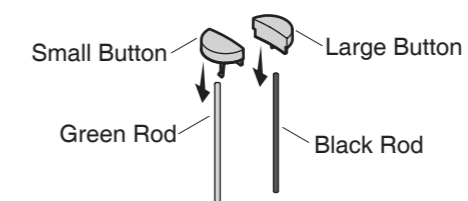

14 Insert the push button with rods into the holes of the push button housing until they click into place.

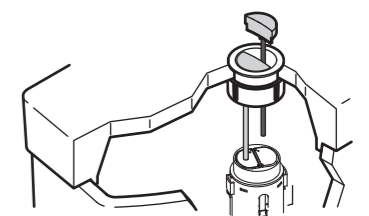

15 Flush several times and check for leaks. **Do not overtighten!**



16 Adjust the water level.

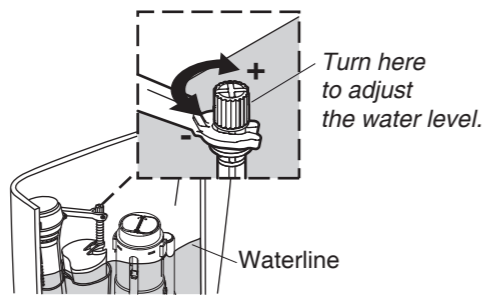

17 Install the tank cover and the seat.

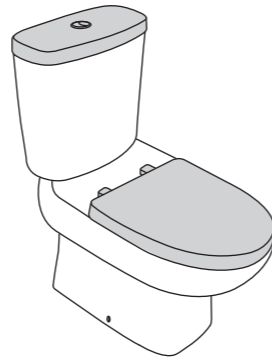

Replace the Seal

1 Shut off the water supply.

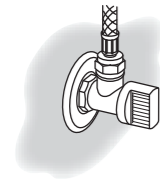

2 Remove the tank cover.

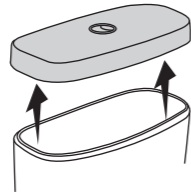

3 Note the position of the colored buttons for reinstallation.

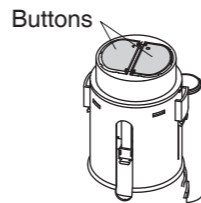

4 Turn the flush valve tabs and pull straight up on the canister.



5 Remove and replace the seal.

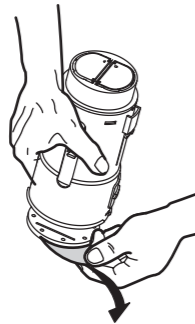

6 Reinstall the canister so it snaps into place.

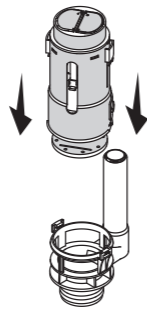

7 Rotate the canister so that the colored buttons are in their original positions.



8 Reinstall the tank cover.

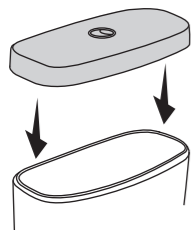

9 Turn on the water supply.

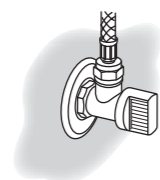

10 Flush several times and check for leaks. **Do not overtighten!**

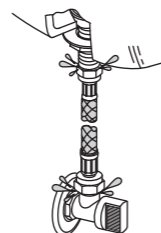

Troubleshooting

Symptoms	Recommended Action
1. Poor flush.	A. Adjust the tank water level to match the waterline. B. Fully open the water supply shut-off valve. C. Clear obstructions from the trapway, jet, or bowl rim holes. D. Clear obstructions from the waste line.
2. No flush.	A. Make sure the push button rods are in place. Adjust as needed.
3. The fill valve turns on/off by itself or it runs, allowing water to enter the tank.	A. Adjust push button rods for proper slack so the flush valve seal isn't held off the flush valve. B. Clean or replace the flush valve seal if it is worn, dirty, or misaligned with the valve seat or flush valve seat is damaged. C. Remove the tank and tighten the flush valve nut if flush valve gasket is leaking. Do not overtighten. If leakage continues replace the gasket. D. Clean the fill valve seal of debris or replace the seal assembly. E. Replace the fill valve if the valve float sinks. F. Adjust the tank water level if it is too high.
4. Long tank fill cycle.	A. Fully open the water supply shut-off valve. B. Clean the valve inlet, valve head, or supply line. Flush the lines.
5. Noisy tank fill cycle.	A. Partially close the water supply shut-off valve if the water pressure to the toilet is too high. Check the toilet performance following any such adjustment. B. Remove dirt or obstructions from the valve head. Flush the lines.

Care and Cleaning

WARNING: Risk of property or product damage.
Do not use in-tank cleaners in your toilet. Products containing chlorine (calcium hypochlorite) can seriously damage fittings in the tank. This damage can cause leakage and property damage.

For best results, keep the following in mind when caring for your product:

- Carefully read the cleaner product label to ensure the cleaner is safe for use on the material.
- Always test your cleaning solution on an inconspicuous area before applying to the entire surface.
- Wipe surfaces clean and rinse completely with water immediately after cleaner application. Rinse and dry any overspray that lands on nearby surfaces.
- Do not allow cleaners to sit or soak on the surface.
- Use a soft, dampened sponge or cloth. Never use an abrasive material such as a brush or scouring pad to clean surfaces.
- Be careful not to leave staining materials in contact with the surface for extended periods of time.
- The ideal cleaning technique is to rinse thoroughly and blot dry any water from the surface after each use.

KOHLER®

Asia Customer Service Centre
No. 158, Jiang Chang San Road, Zhabei District, Shanghai, PRC 200436
Tel: +(86) 21 2606 2572 Fax: +(86) 21 6107 8900

Kohler Asia Pacific Limited
29/F, Siu On Centre, 188 Lockhart Road, Wanchai, Hong Kong
Tel: +(852) 3125 7728 Fax: +(852) 2802 2162